

HYVELSTÅL och Tillbehör



Wood-Mizer®

from forest to final form

MEKWOOD AB

Magasinsgatan 29, 812 31 Storvik - 0290-515 65, 070-679 79 65
info@mekwood.se - www.mekwood.se - www.woodmizer.se

Kombinationer

REGEL & TRALL

■ Rak

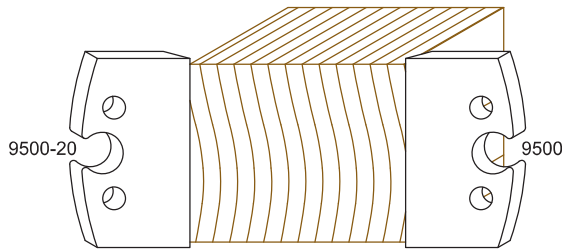

■ Avrundning, enkel

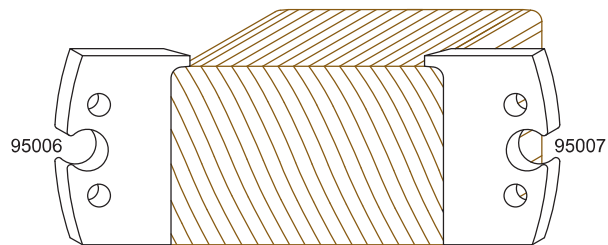

■ Avrundning, dubbel, 22 mm

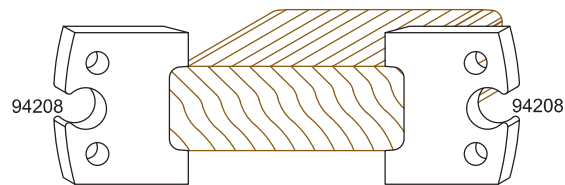

■ Avrundning, dubbel, 25 mm

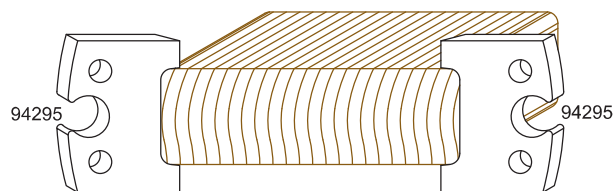

■ Avrundning, dubbel, 28 mm

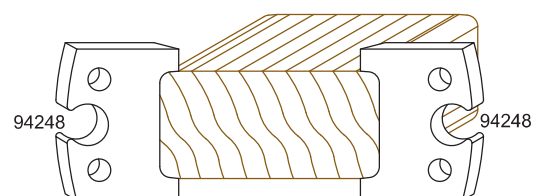

■ Avrundning, dubbel, 45 mm

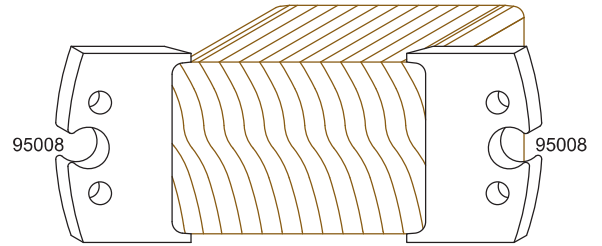

■ Avrundning, dubbel, 48 mm

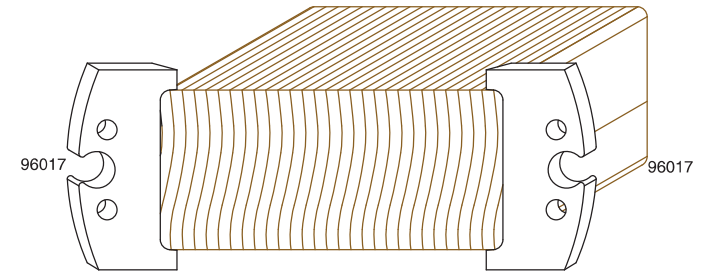

■ Grepp profil 1

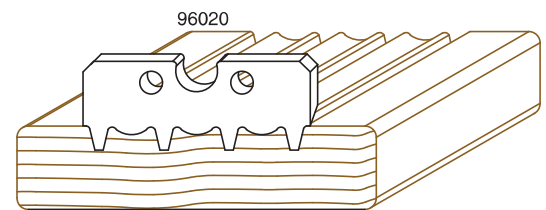

■ Grepp profil 2

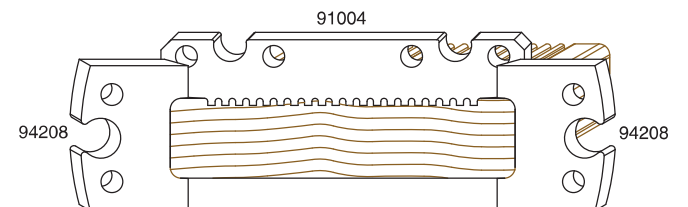

■ Grepp profil 3

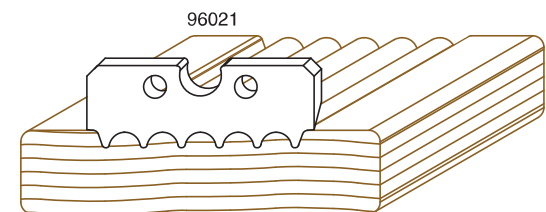

NOT & SPONT

■ Not & Spont, 4 mm (tät 0,1 mm)

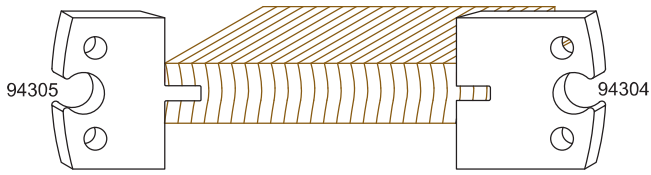

■ Not & Spont, 4,5 mm (tät 0,1 mm)

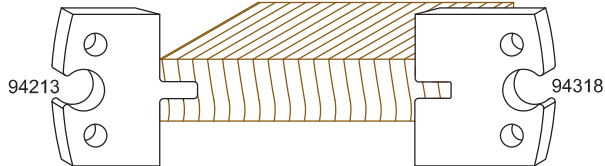

■ Not & Spont, 6 mm (tät 0,1 mm)

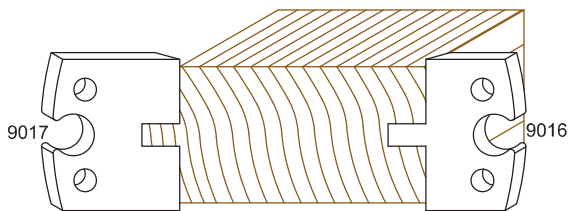

■ Not & Spont, 6 mm (Råspont)

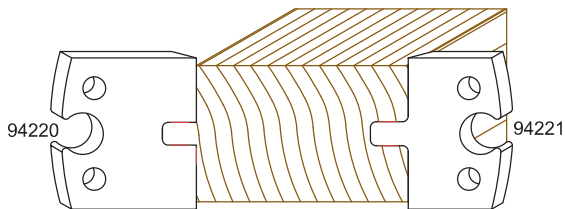

■ Not & Spont, 8 mm (Golvspont)

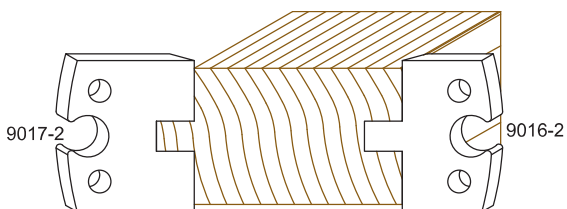

■ Not & Spont, 10 mm (Golvspont)

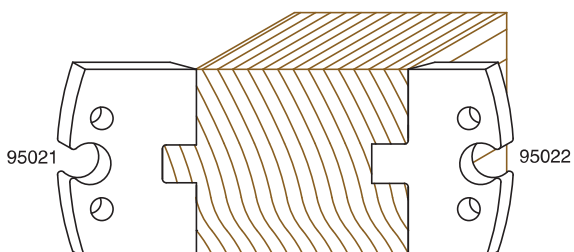

■ Not & Spont, 10 mm (tät)

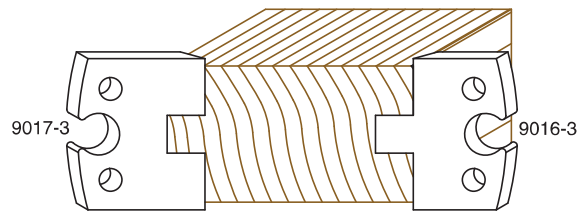

■ Not & Spont (Badkar)

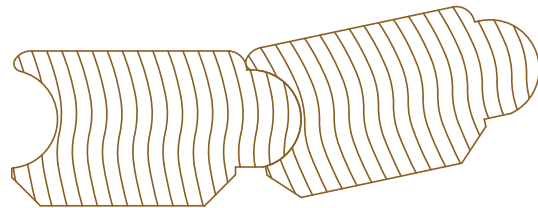
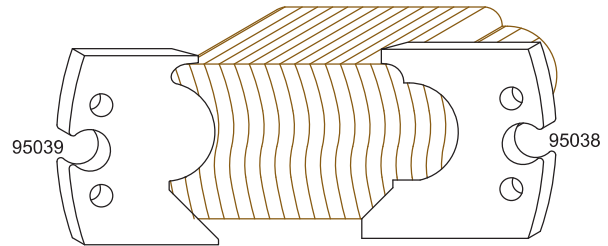

■ Not & Spont (Badkar)

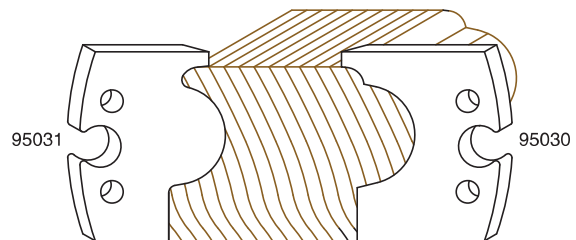

■ Not & Spont (Golvspont med spikfas)

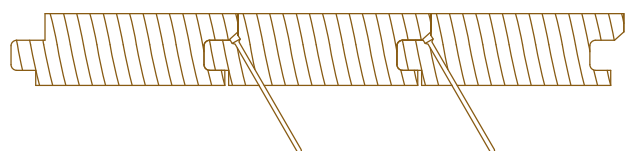
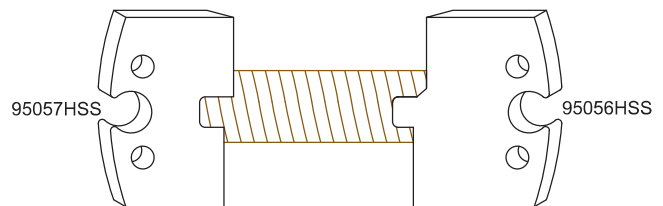

■ **Not & Spont** (Golvspont med spikfas)

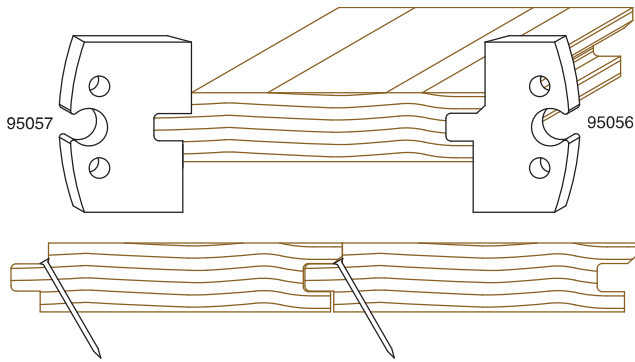

■ **Not & Spont** (Golvspont)

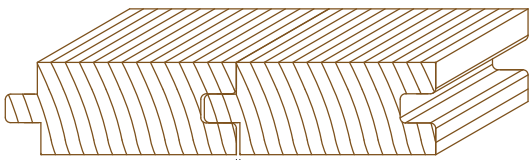
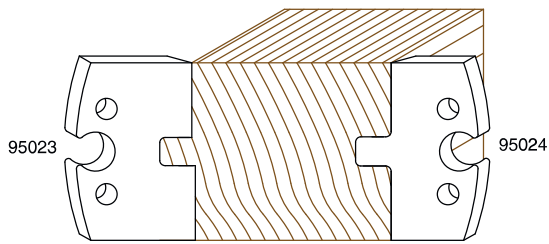

■ **Not & Spont** (Fasad golvprofil med spikfas)

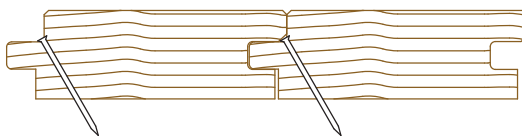
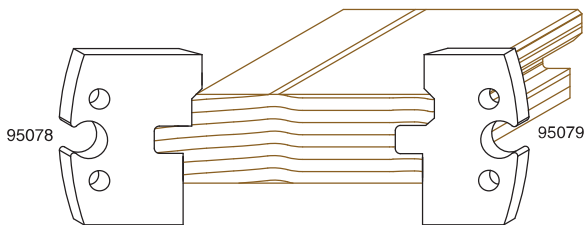

■ **Not & Spont** (Kantotstål)

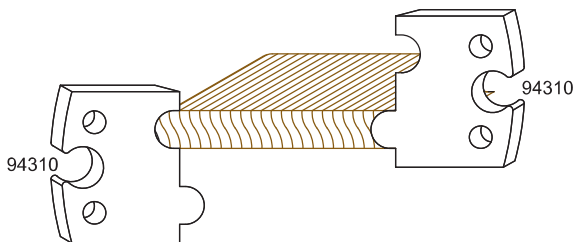

■ **Not & Spont** (Friggebod)

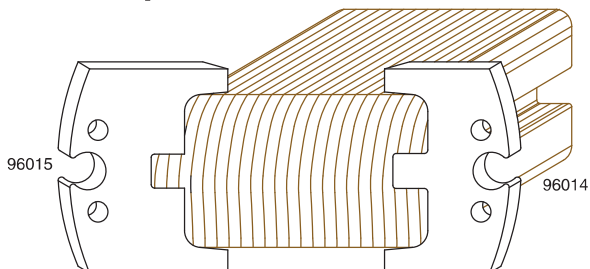

■ **Not & Spont** (Friggebod usa)

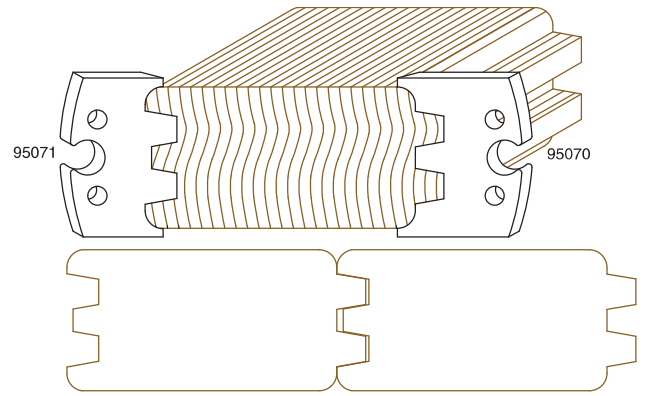

UTOMHUSPANELER

■ **Faspanel**

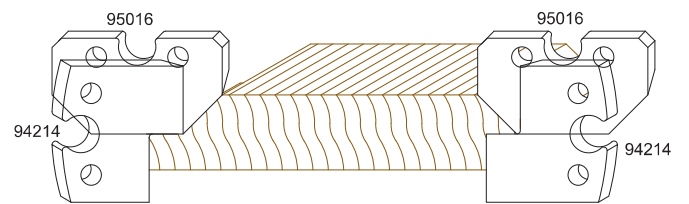

■ **Faspanel, not 3 mm**

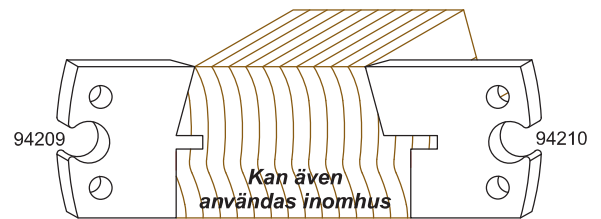

■ **Faspanel, not 5 mm**

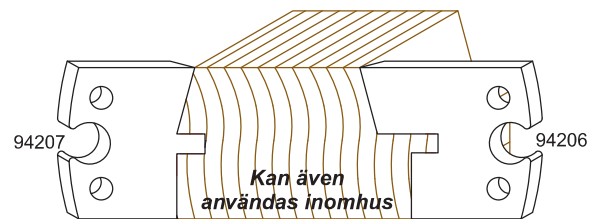

■ **Avrundad panel**

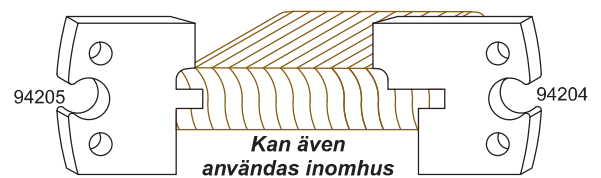

■ **Hålkälspanel**

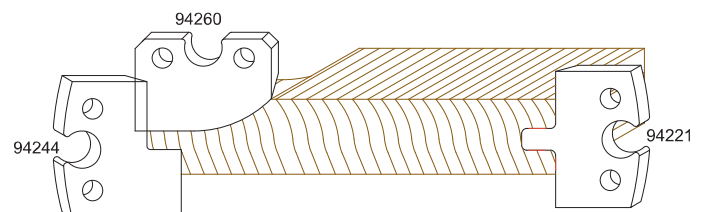

■ Stockpanel

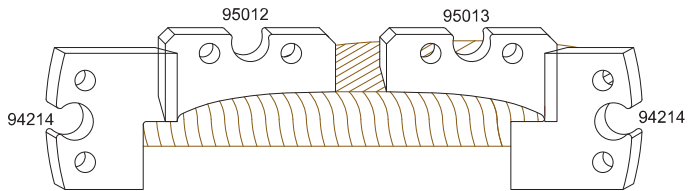

■ Norgepanel, svanhals

Stående not- och spontpanel med sågad framsida. 4-skärig kutter behövs.

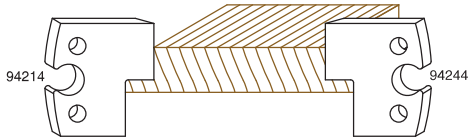
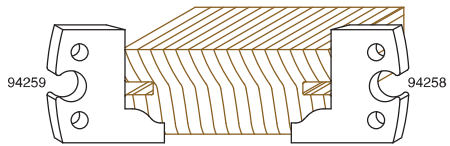
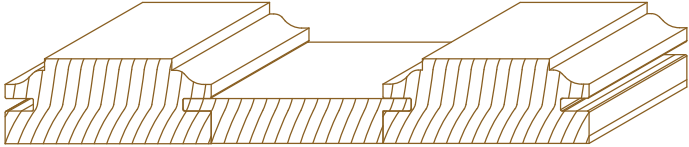

■ Norgepanel, hälkäl

Stående not- och spontpanel med sågad framsida. 4-skärig kutter behövs.

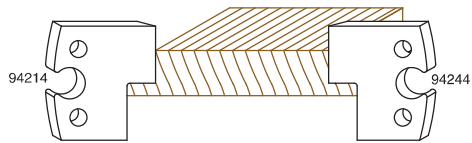
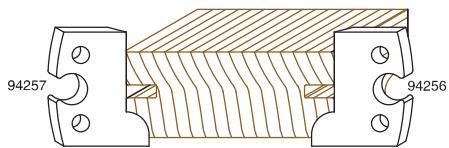
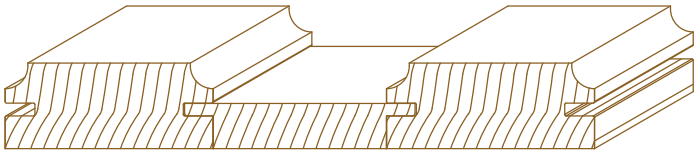

■ Stockhuspanel, 45 mm

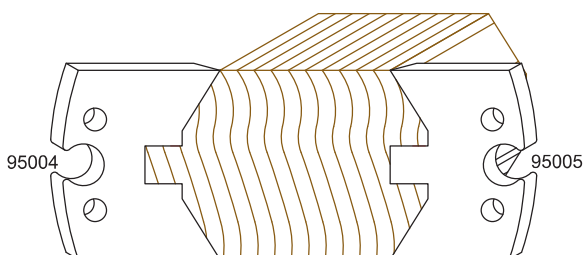

■ Stockhuspanel, 70 mm

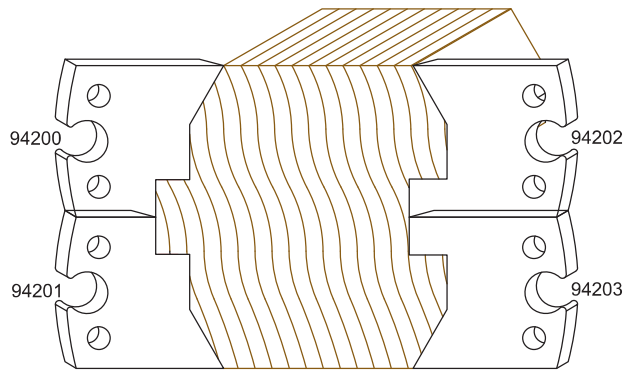

■ Fjällpanel

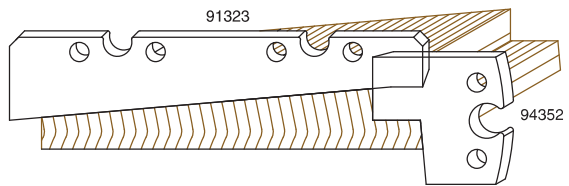

INOMHUSPANELER

■ Morapanel

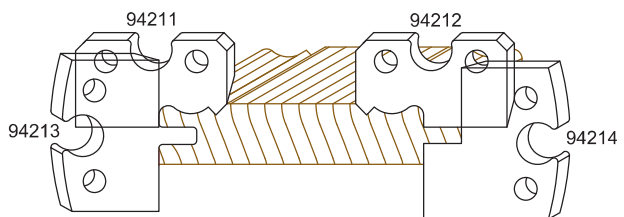

■ Pärlspont

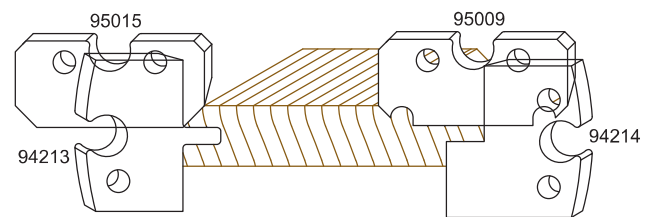

■ Pärlspont med mittprofil

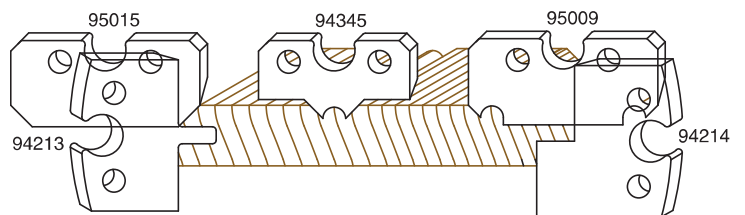

■ Stor pärlspont

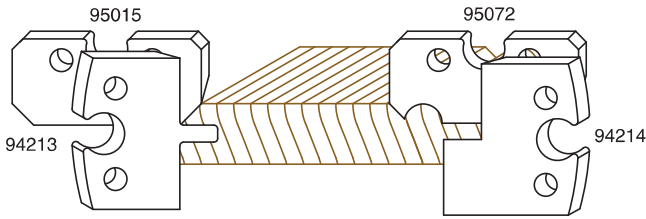

■ Avrundad panel

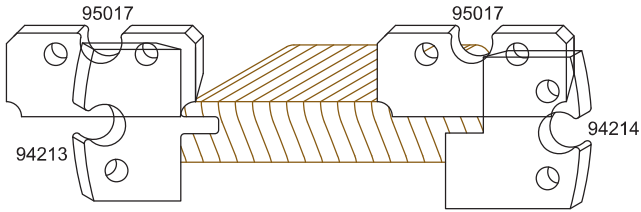

■ Faspanel

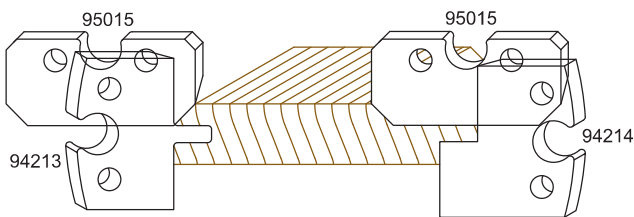

■ 45° Faspanel

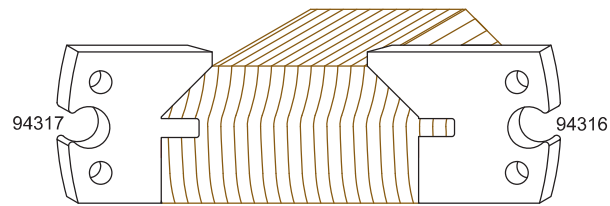

■ Dubbel 45° Faspanel

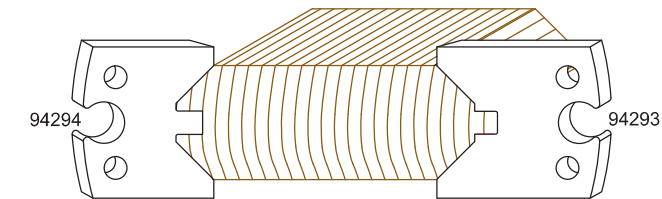

■ Faspanel med mittprofil

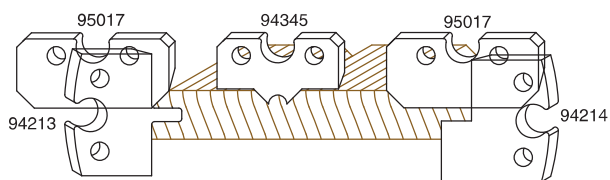

■ Faspanel med mittprofil

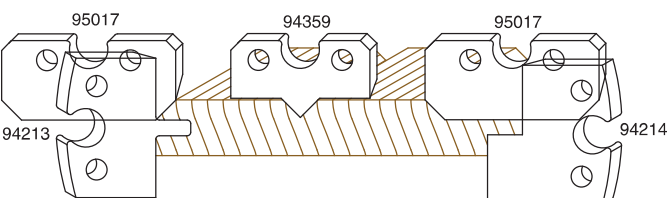

■ Faspanel

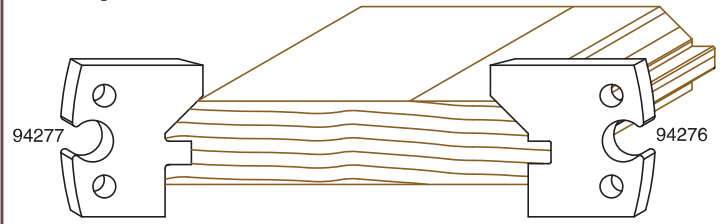

■ Enkel takpanel

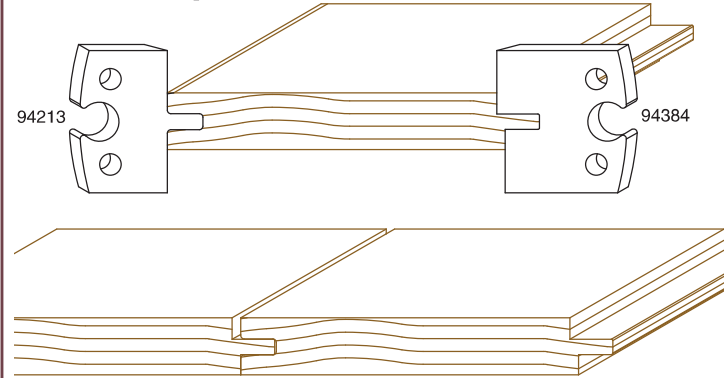

LOCKPANEL

■ Hattlock

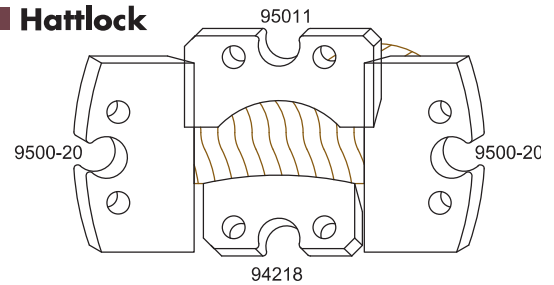

■ Faslock

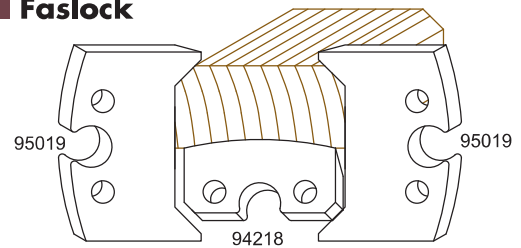

■ Dekorlock

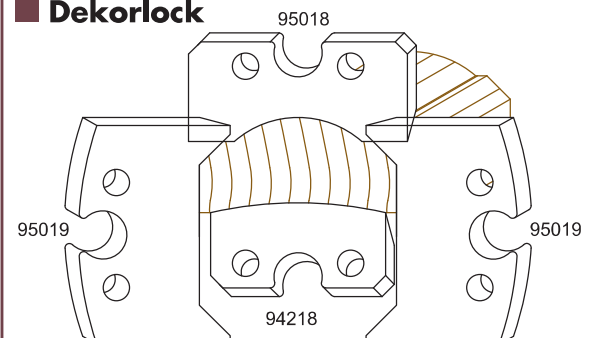

■ Dekorlock

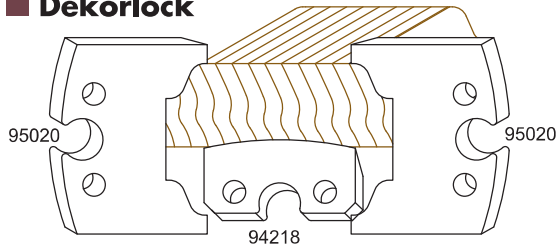

■ Dekorlock

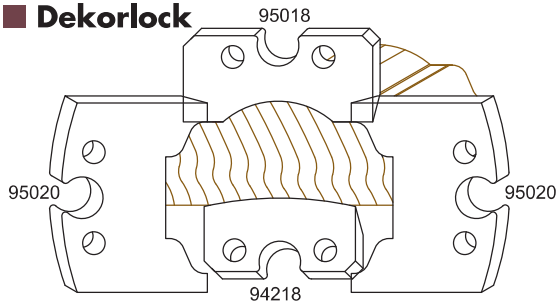

BRÖSTLIST

■ Rundad

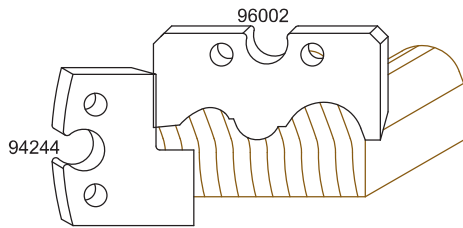

■ Profil

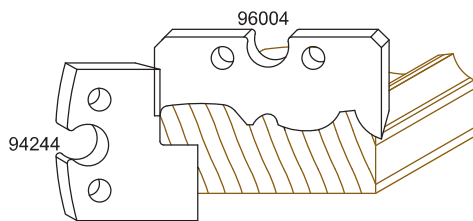

■ Profil

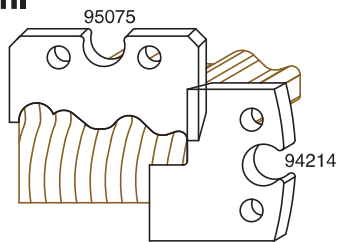

■ Villa Frimodig

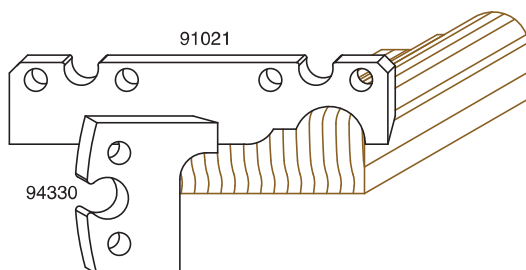

SPÄRNING & URFRÄSNING

■ Spärning av foder

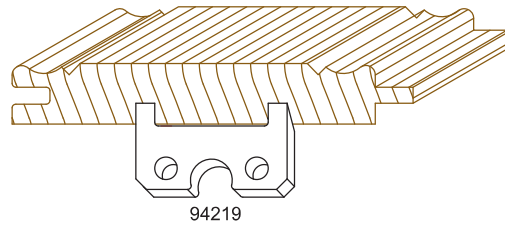

■ Urfräsning av foder

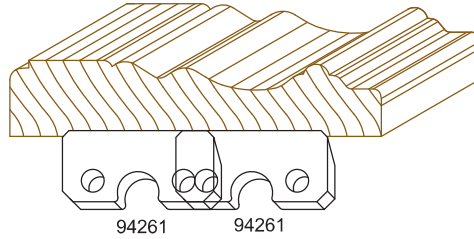

■ Urfräsning av golvlist

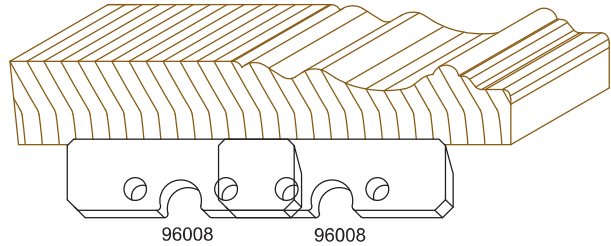

GOLVLIST

■ Smyglist

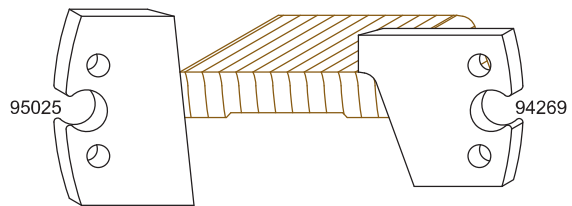

■ Stocklist

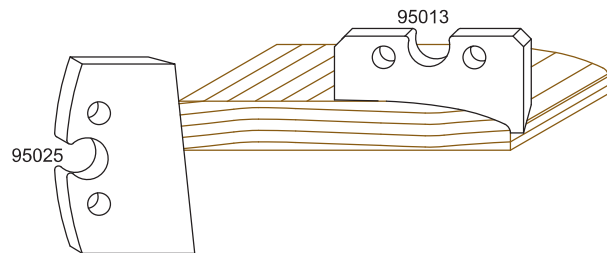

■ Svanhalslist

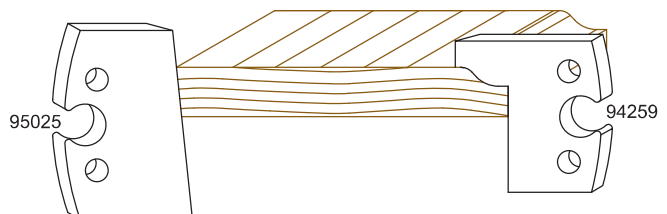

■ Kvartstavslist

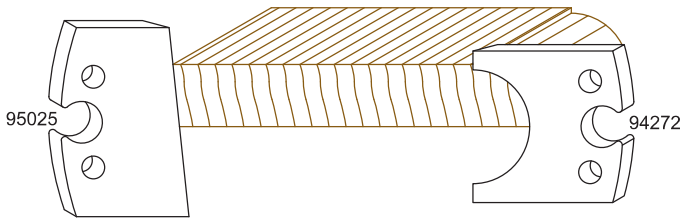

■ Allmogelist

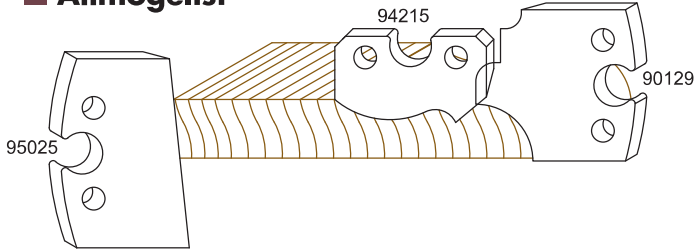

■ Hagalist

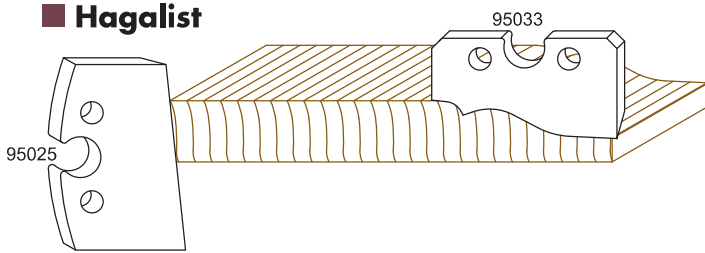

■ Gamlestadsl

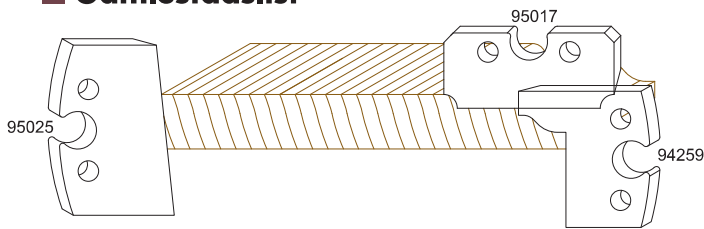

■ Stockholmslist

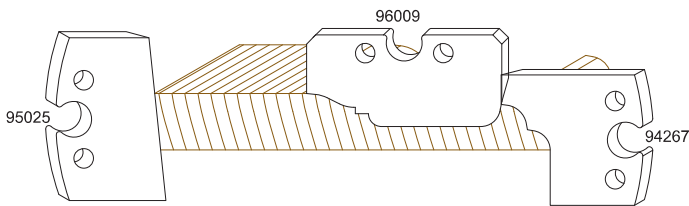

■ Gotlandslist

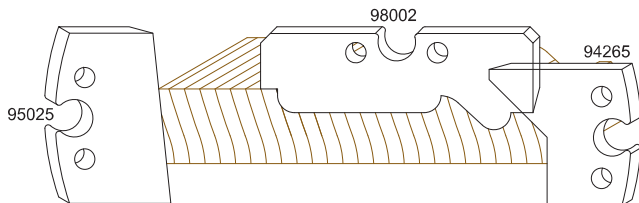

■ Hallandslist

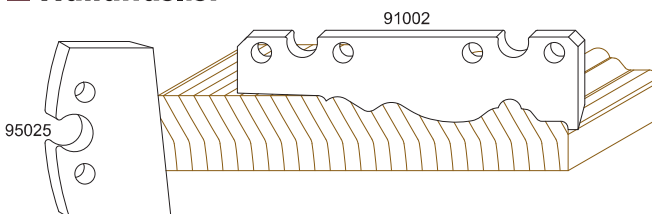

■ Backalist

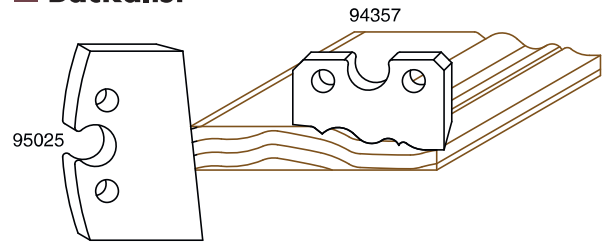

■ Utbylist

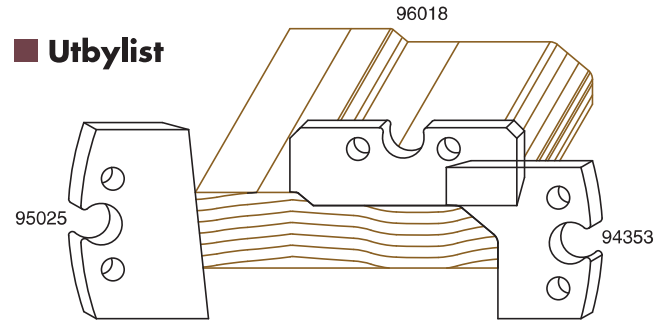

■ Villa Frimodig

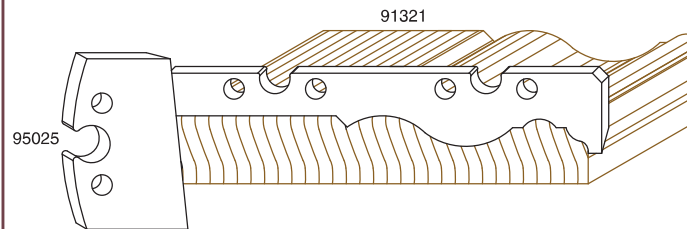

DÖRRPROFIL

■ Dörrprofil 1

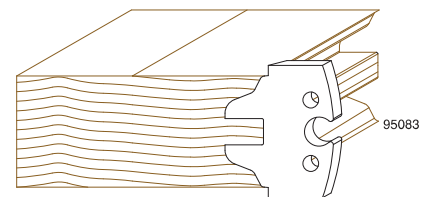
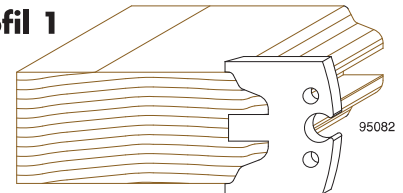

■ Dörrprofil 2

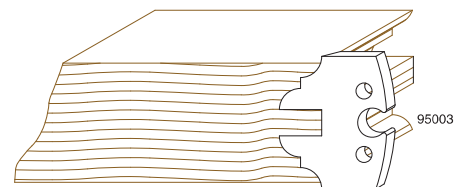
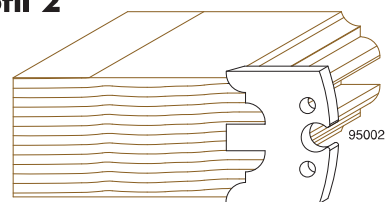

HÖRNBLOSS

Förbindning

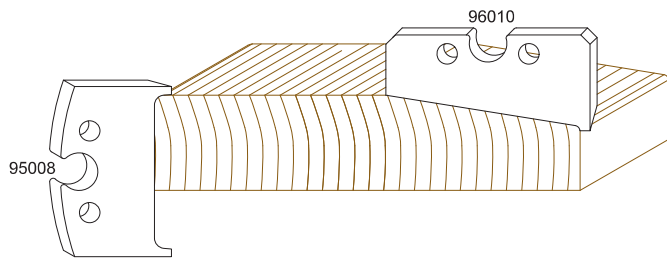

En dekorativ förbindningskloss för att få snygga avslutningar på olika lister. Mycket bra vid kraftiga profiler på listerna.

Dekorfoder, 95 mm

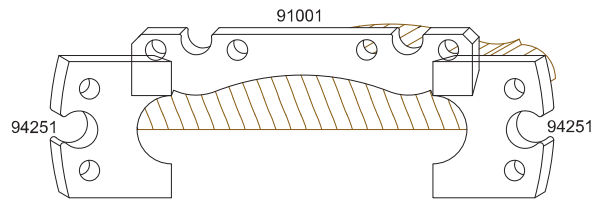

Gamlestads

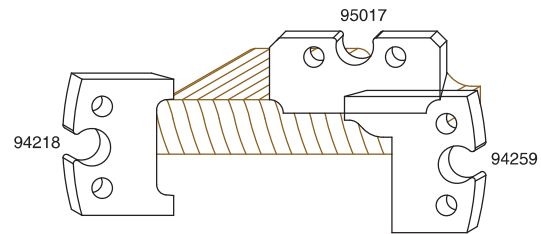

Gotland

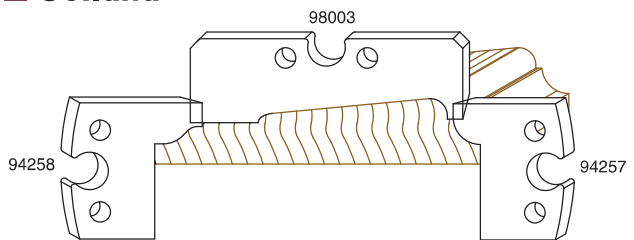

Hagafoder

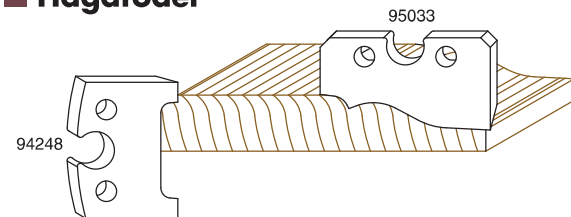

Halland

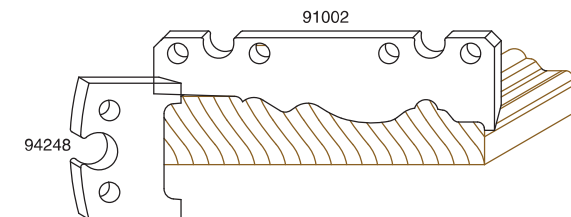

Kvartstav

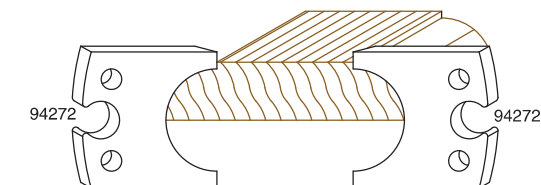

Doortrim

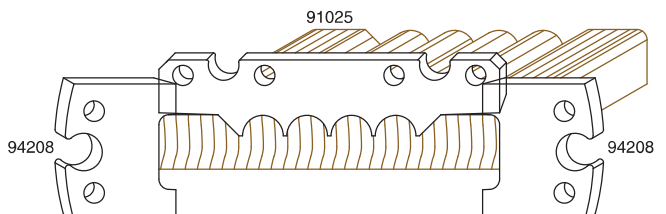

FODER

Allmogefoder

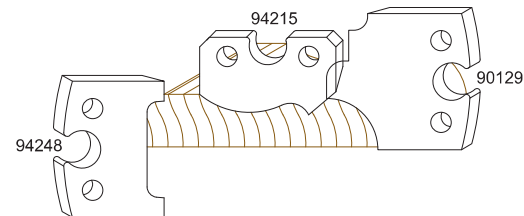

Amerikafoder, 57mm

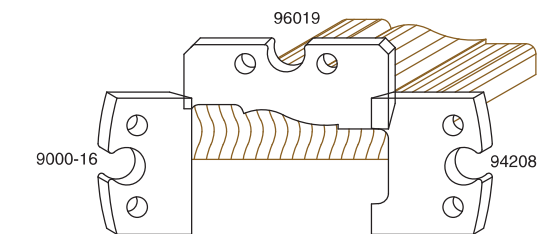

Backafoder

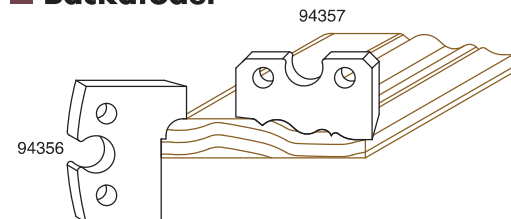

Dekorfoder, 70 mm

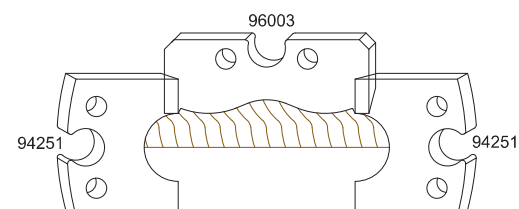

Rundat foder

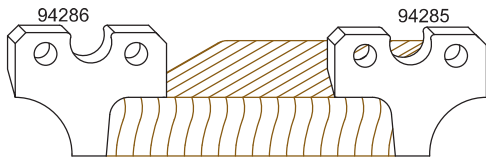

Skiröfoder

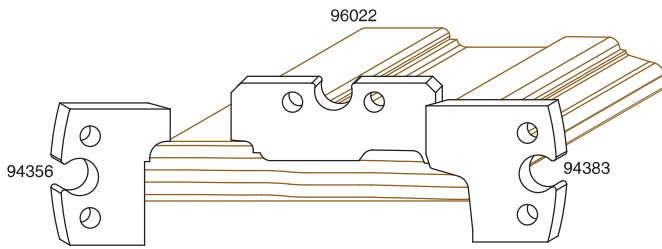

Stockholm

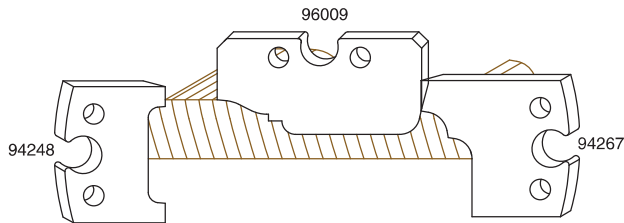

Svanhals

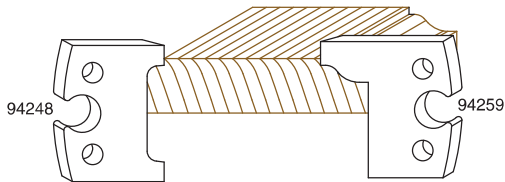

Sätrafoder

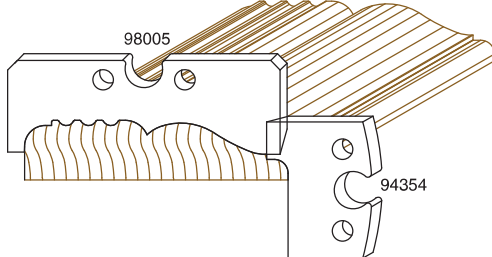

Utbyfoder

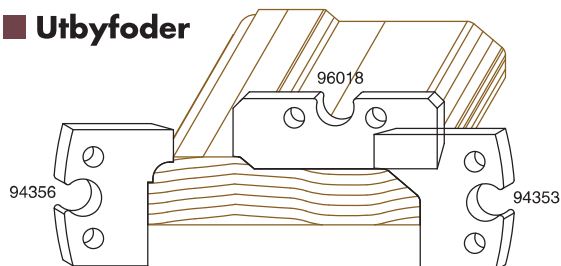

Villa Frimodig

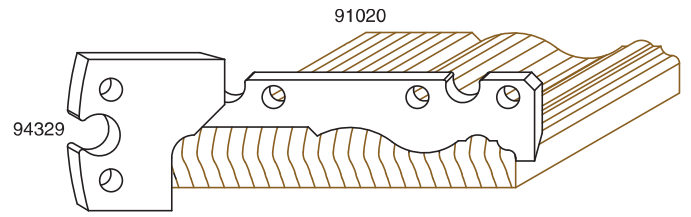

TAKLIST

Skugglist

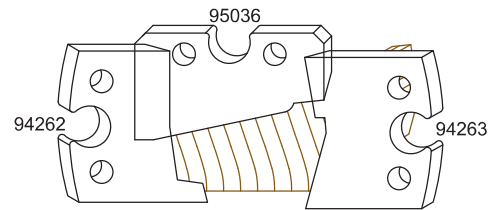

Trappstegslist

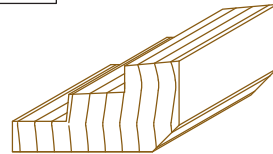
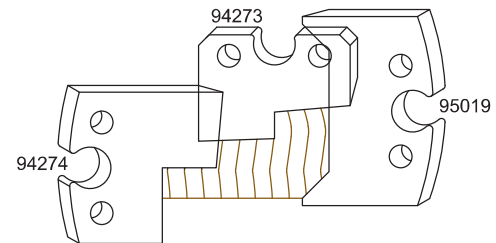

Kvartstavstaklist

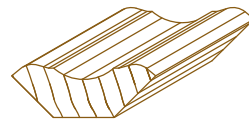
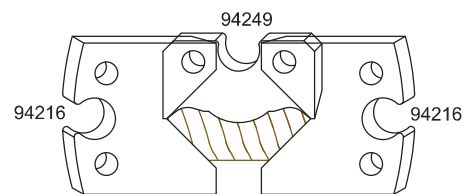

Profiltaklist, 70 mm

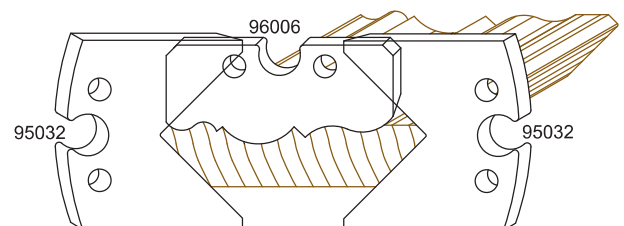

■ Svanhalstaklist, 45 mm

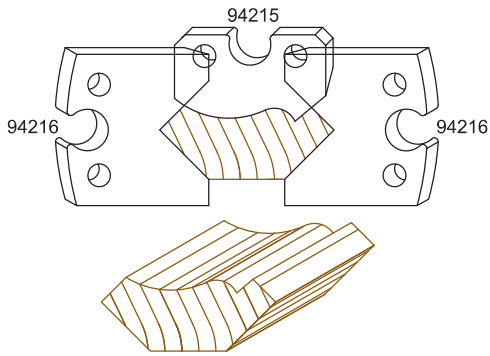

■ Svanhalstaklist, 56 mm

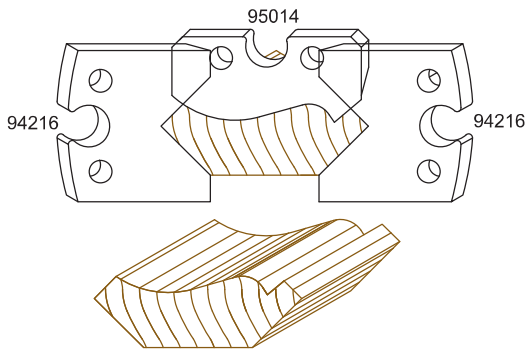

■ Svanhalstaklist, 68 mm

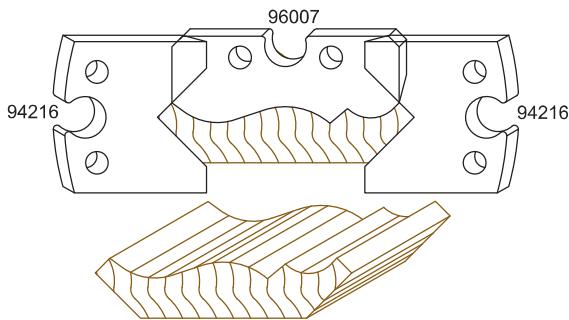

■ Svanhalstaklist, 80 mm

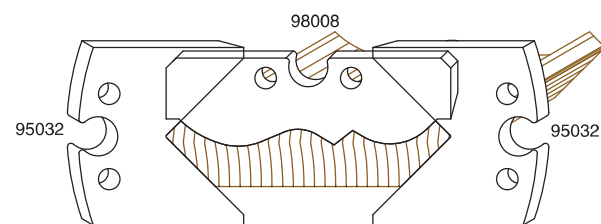

■ Svanhalstaklist, 95 mm

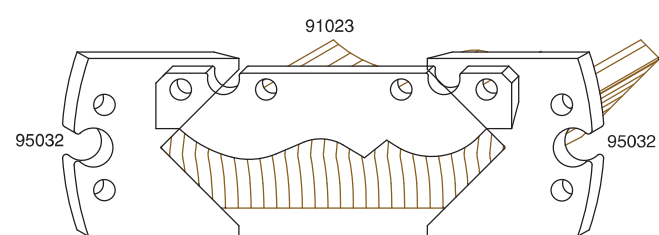

■ Svanhalstaklist, 120 mm

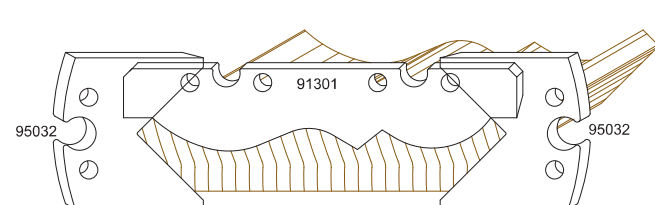

■ Svanhalstaklist usa, 80 mm

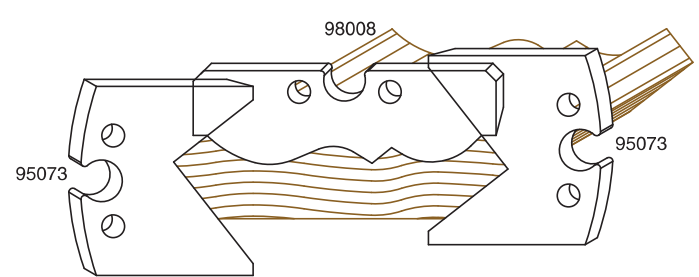

■ Hålkälstaklist, 45 mm

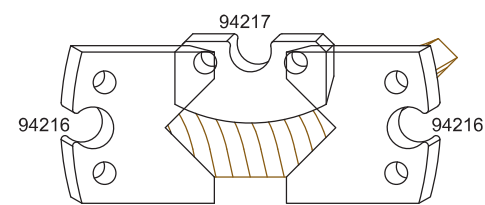

■ Hålkälstaklist, 60 mm

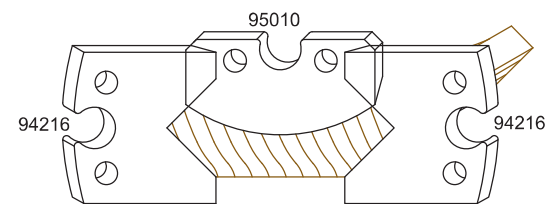

■ Hålkälstaklist, 70 mm

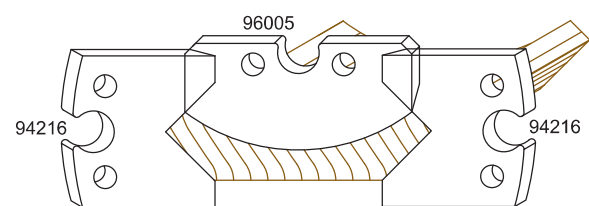

■ Hålkälstaklist, 95 mm

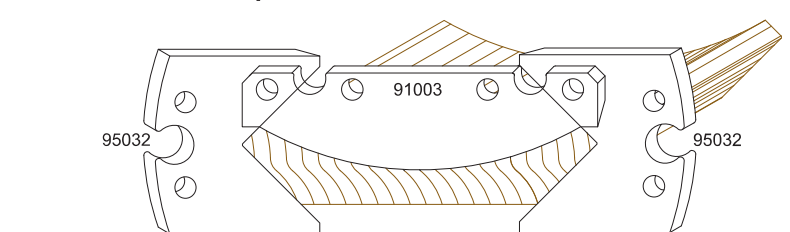

■ Stukaturlist

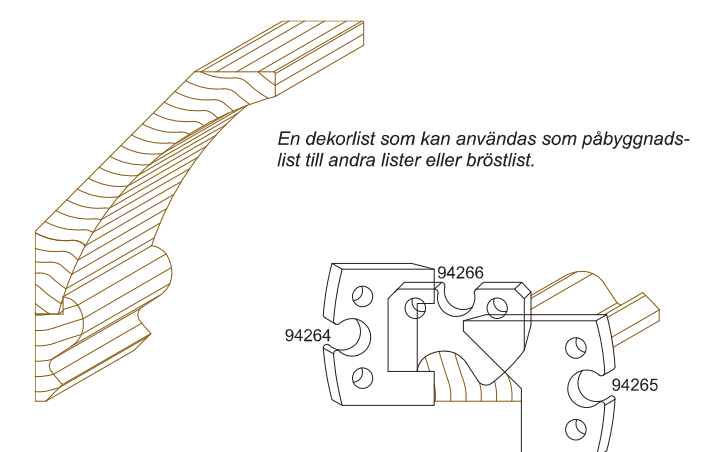

Backataklist

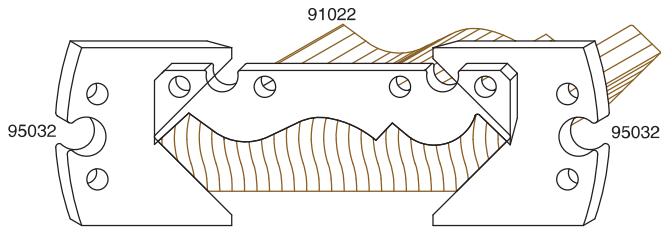

Utbylist

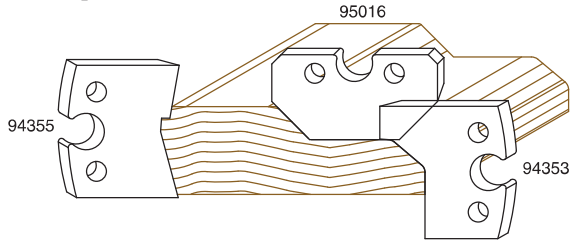

Villa Frimodig

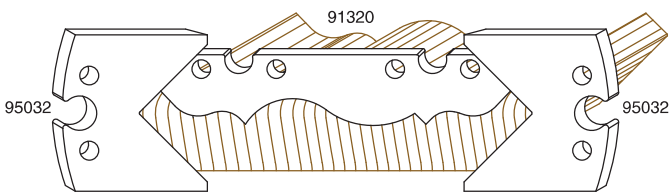

KVARTSSTAV

Kvartsstav, 15 mm

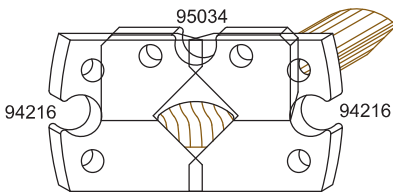

Kvartsstav, 21 mm

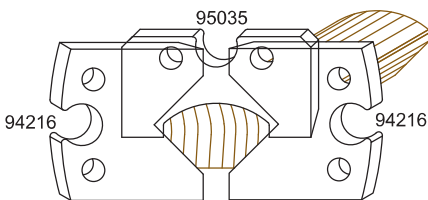

GARDINSTÅNG

Diameter 30 mm

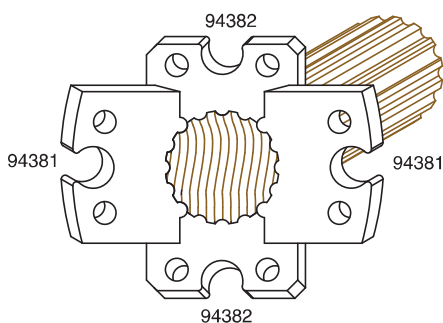

RUNDSTAV

Rundstav, 21 mm

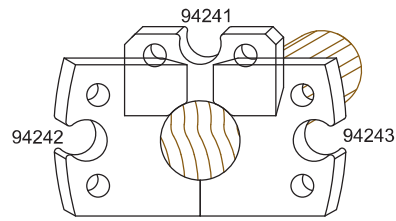

Rundstav, 24 mm

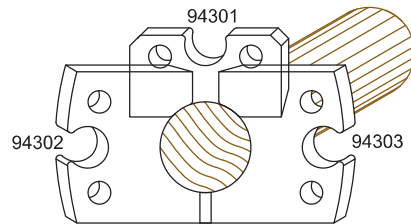

Rundstav, 27 mm

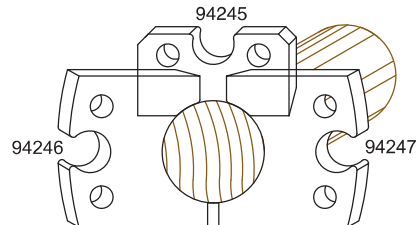

Rundstav, 40 mm

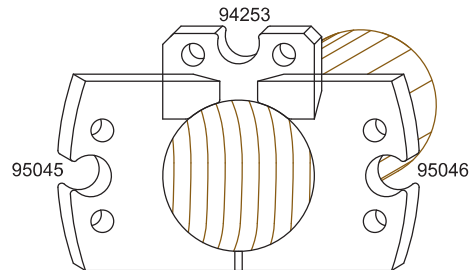

FASSTÅL

Dubbel 45° fasning

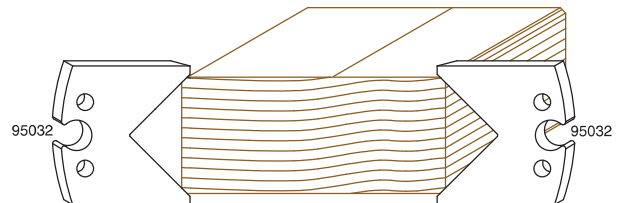

Enkel 45° fasning

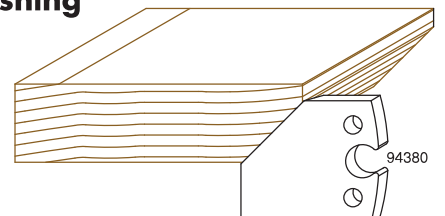

UNDERBRÄDA TILL FÖNSTER

■ Profil

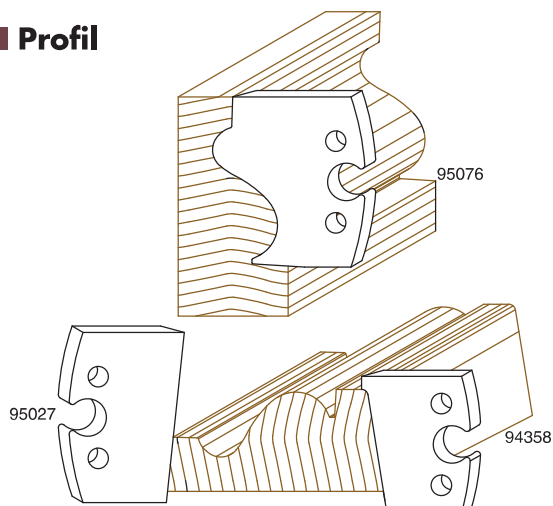

■ Villa Frimodig

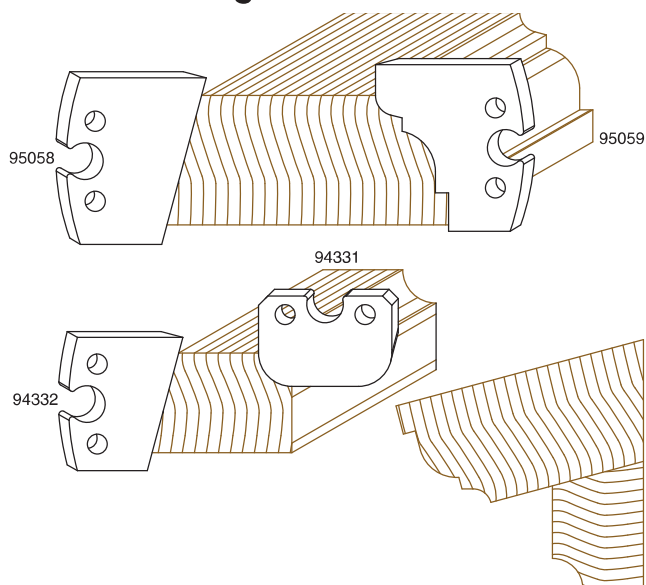

FALSSTÅL

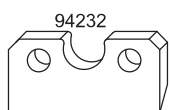

94232HSS
Detta stål ger 2 mm falsdjup

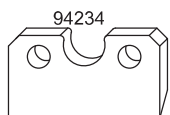

94234HSS
Detta stål ger 4 mm falsdjup

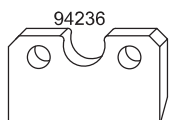

94236HSS
Detta stål ger 6 mm falsdjup

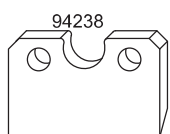

94238HSS
Detta stål ger 8 mm falsdjup

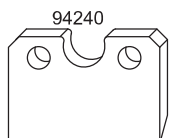

94240HSS
Detta stål ger 10 mm falsdjup

STÅL TILL SOLOHYVELN

I Solohyveln kan i vissa fall mer än 10 mm utstick användas i överkuttern, vilket gör att dessa stål enbart passar till denna maskinen. Ett sådant stål är 95028HSS.

■ Rundat foder

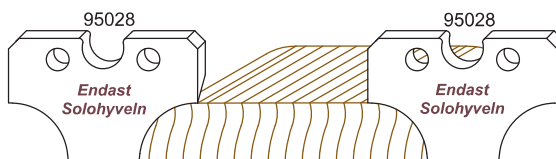

■ Rundad golvlist

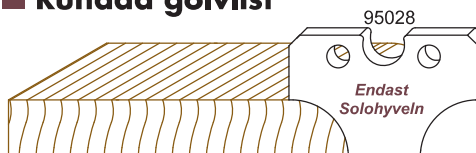

■ Allmogefoder

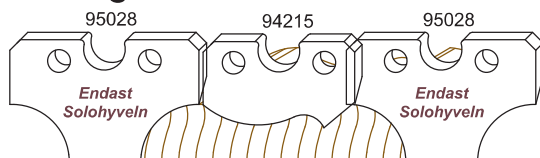

■ Allmogegolvlist

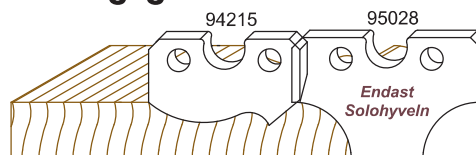

■ Faspanel

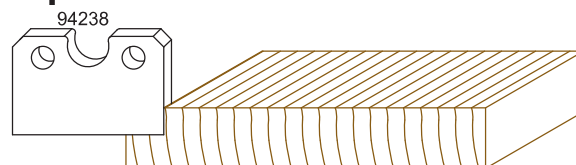

Starta med att hyvla en fals på baksidan.

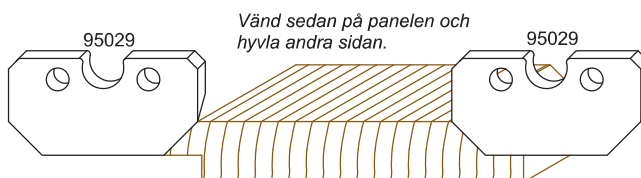

■ Stål för trallvirke

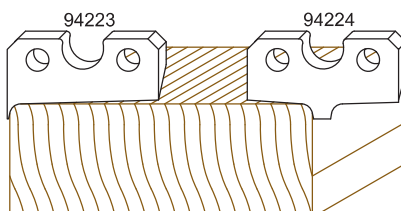

Profilstål i HSS 40 x 4 mm

40 mm

■ 94200HSS

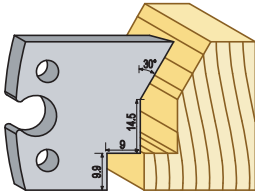

■ 94201HSS

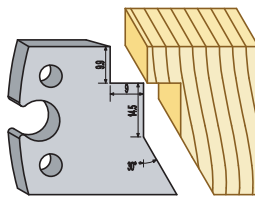

■ 94202HSS

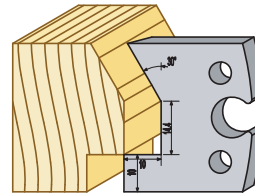

■ 94203HSS

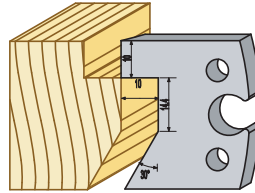

■ 94204HSS

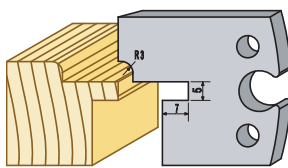

■ 94205HSS

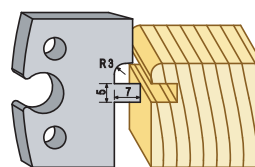

■ 94206HSS

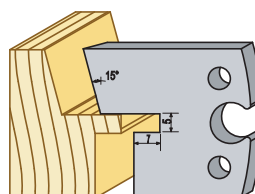

■ 94207HSS

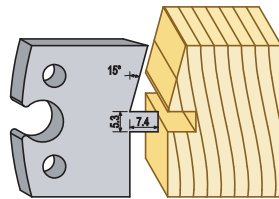

■ 94208HSS

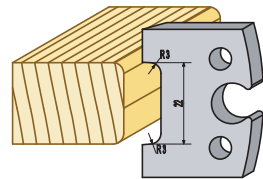

■ 94209HSS

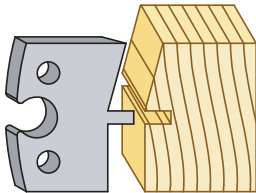

■ 94210HSS

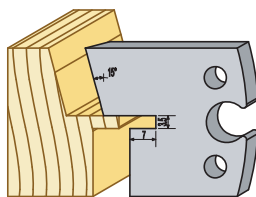

■ 94211HSS

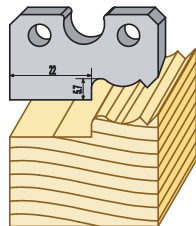

■ 94212HSS

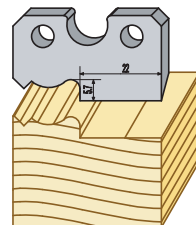

■ 94213HSS

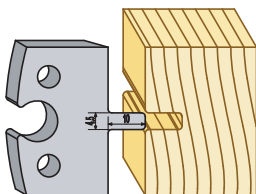

■ 94214HSS

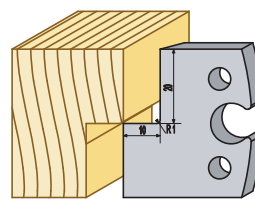

■ 94215HSS

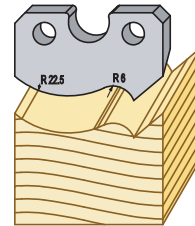

■ 94216HSS

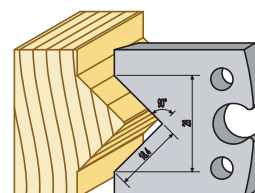

■ 94217HSS

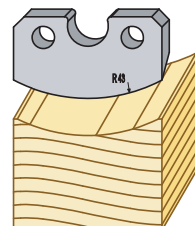

■ 94218HSS

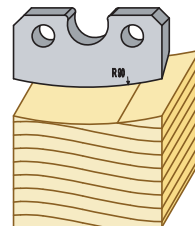

■ 94219HSS

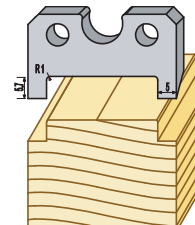

■ 94220HSS

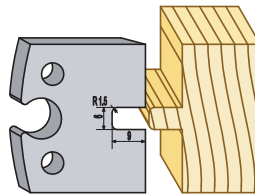

■ 94221HSS

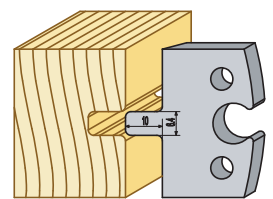

■ 94222HSS

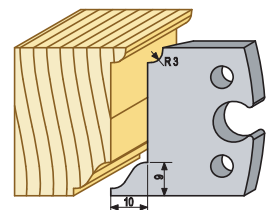

■ 94223HSS

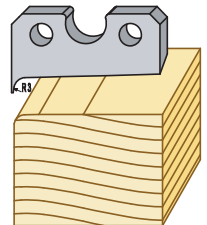

■ 94224HSS

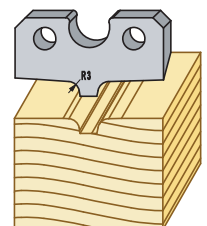

■ 94225HSS

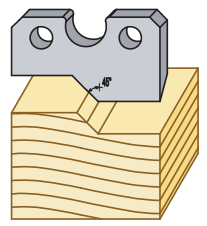

■ 94226HSS

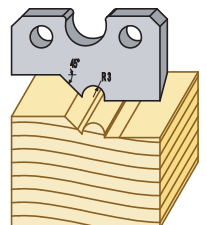

■ 94227HSS

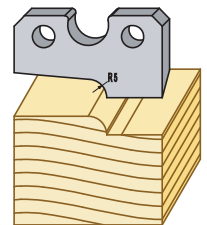

■ 94229HSS

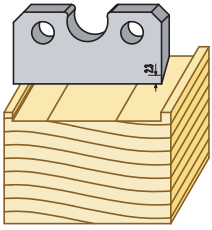

■ 94232HSS

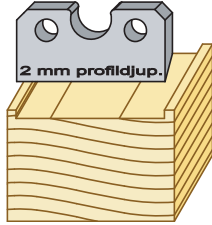

■ 94234HSS

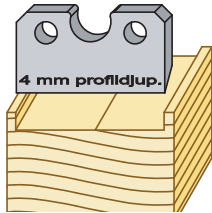

■ 94236HSS

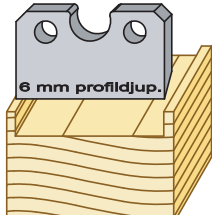

■ 94238HSS

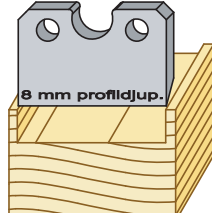

■ 94240HSS

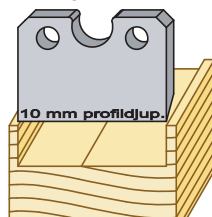

■ 94241HSS

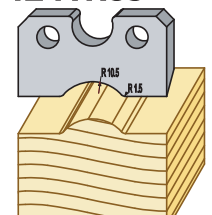

■ 94242HSS

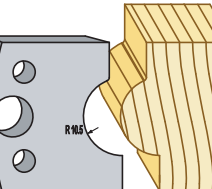

■ 94243HSS

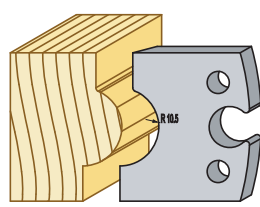

■ 94244HSS

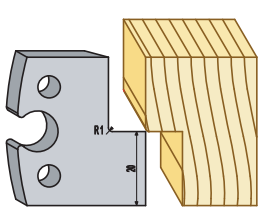

■ 94245HSS

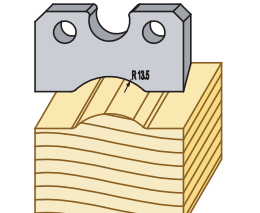

■ 94246HSS

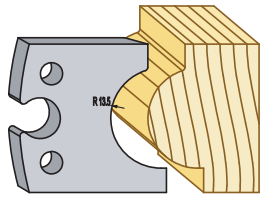

■ 94247HSS

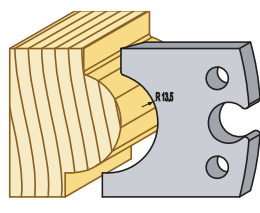

■ 94248HSS

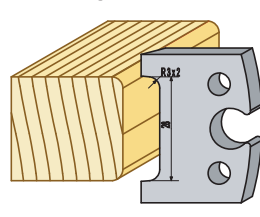

■ 94249HSS

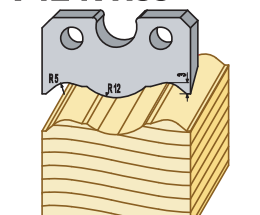

■ 94250HSS

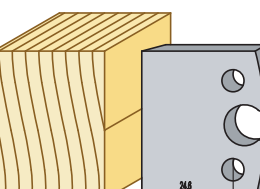

■ 94251HSS

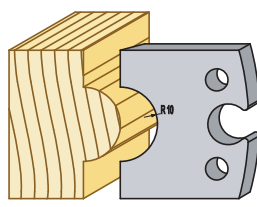

■ 94253HSS

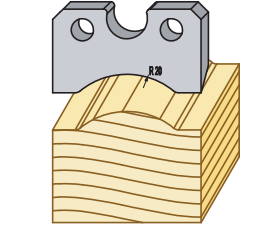

■ 94254HSS

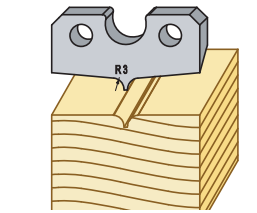

■ 94255HSS

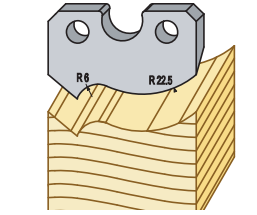

■ 94256HSS

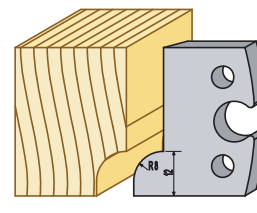

■ 94257HSS

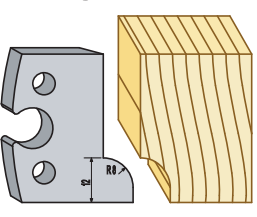

■ 94258HSS

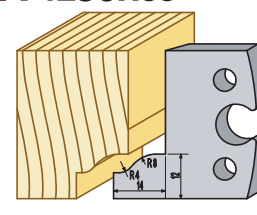

■ 94259HSS

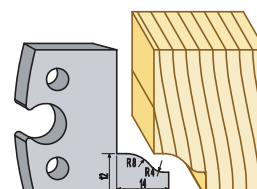

■ 94260HSS

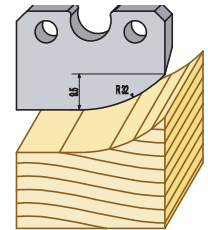

■ 94261HSS

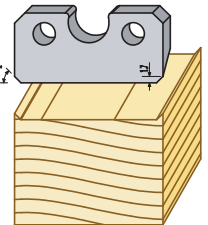

■ 94262HSS

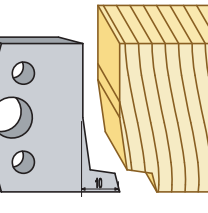

■ 94263HSS

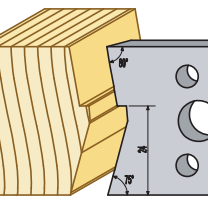

■ 94264HSS

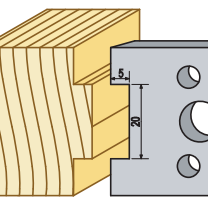

■ 94265HSS

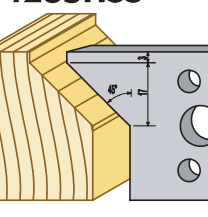

■ 94266HSS

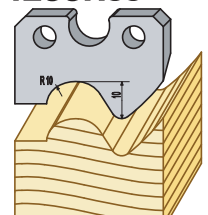

■ 94267HSS

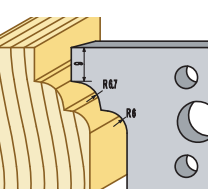

■ 94268HSS

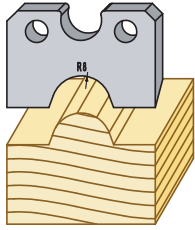

■ 94269HSS

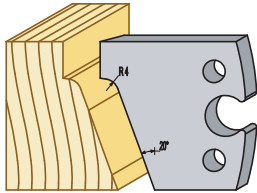

■ 94270HSS

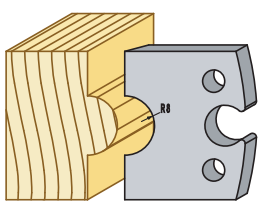

■ 94271HSS

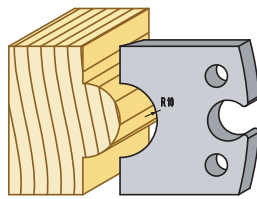

■ 94272HSS

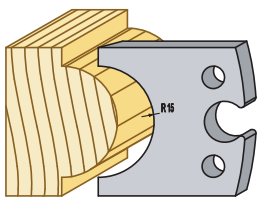

■ 94273HSS

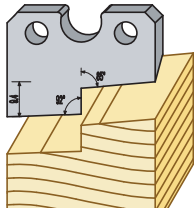

■ 94274HSS

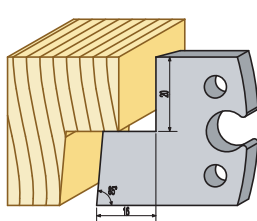

■ 94275HSS

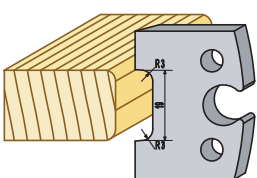

■ 94276HSS

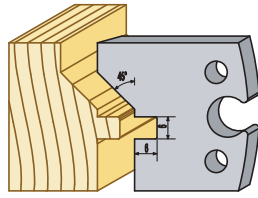

■ 94277HSS

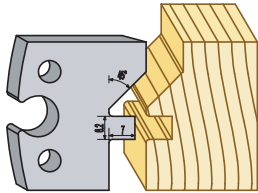

■ 94278HSS

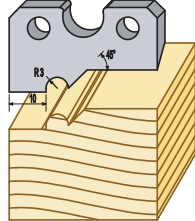

■ 94279HSS

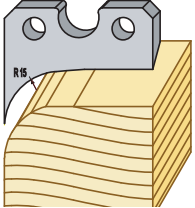

■ 94280HSS

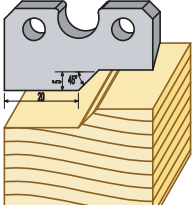

■ 94281HSS

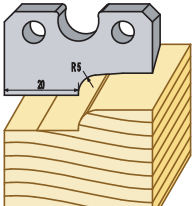

■ 94282HSS

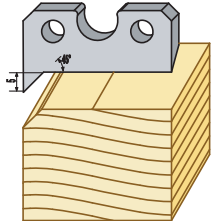

■ 94283HSS

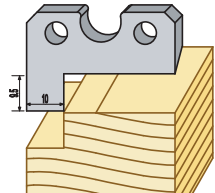

■ 94284HSS

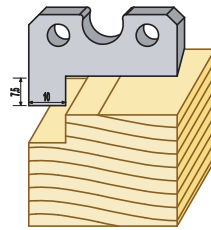

■ 94285HSS

Endast Solohyveln

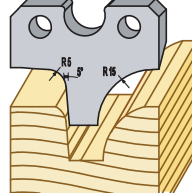

■ 94286HSS

Endast Solohyveln

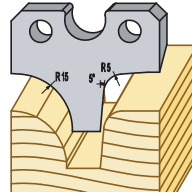

■ 94287HSS

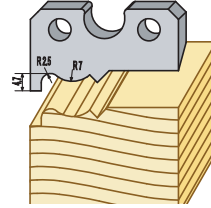

■ 94289HSS

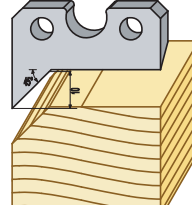

■ 94290HSS

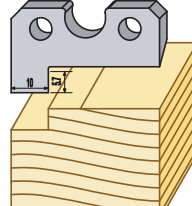

■ 94291HSS

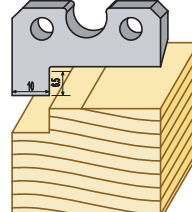

■ 94292HSS

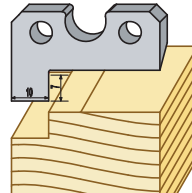

■ 94293HSS

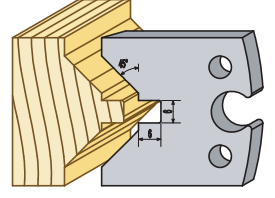

■ 94294HSS

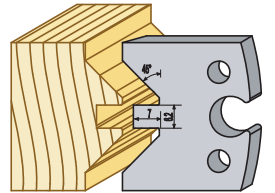

■ 94295HSS

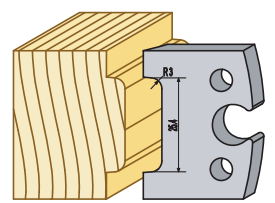

■ 94296HSS

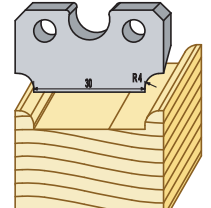

■ 94297HSS

Endast Solohyveln

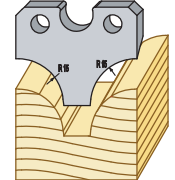

■ 94298HSS

Endast Solohyveln

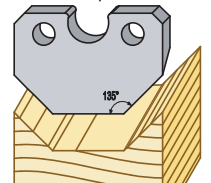

■ 94299HSS

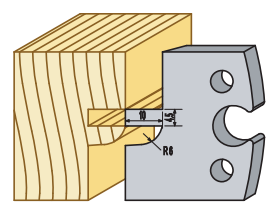

■ 94300HSS

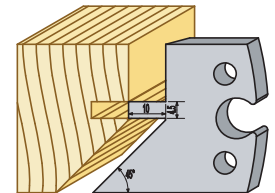

■ 94301HSS

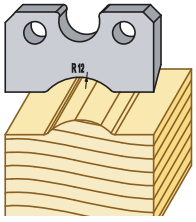

■ 94302HSS

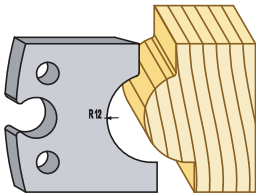

■ 94303HSS

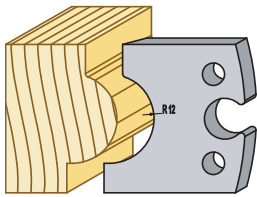

■ 94304HSS

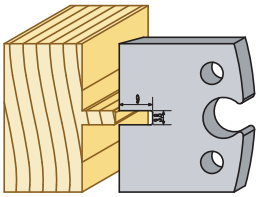

■ 94305HSS

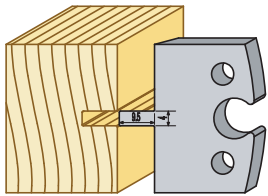

■ 94306HSS

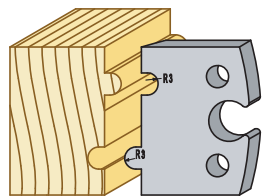

■ 94308HSS

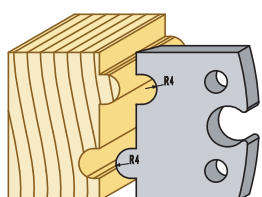

■ 94310HSS

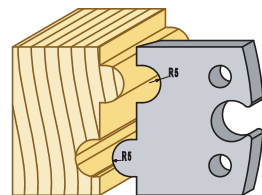

■ 94312HSS

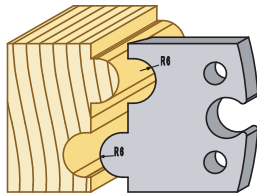

■ 94314HSS

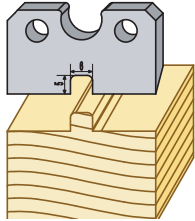

■ 94315HSS

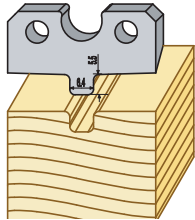

■ 94316HSS

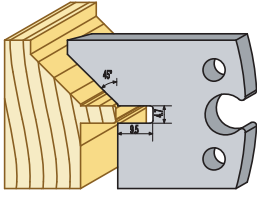

■ 94317HSS

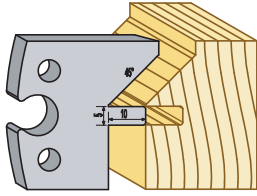

■ 94318HSS

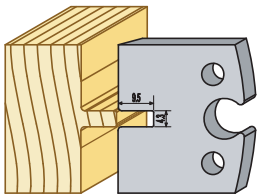

■ 94320HSS

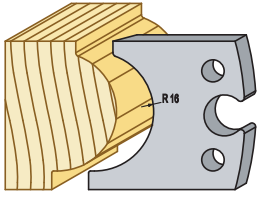

■ 94321HSS

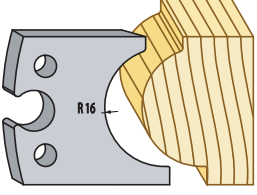

■ 94322HSS

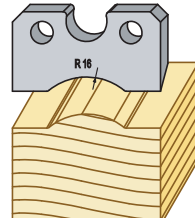

■ 94323HSS

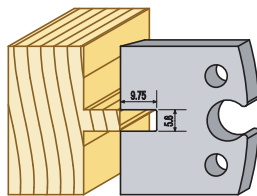

■ 94324HSS

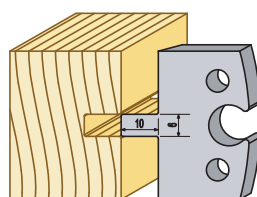

■ 94325HSS

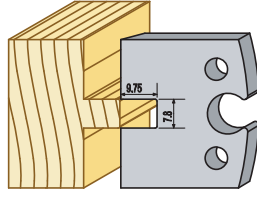

■ 94326HSS

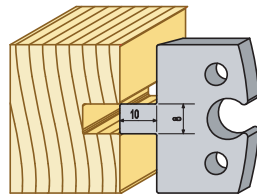

■ 94327HSS

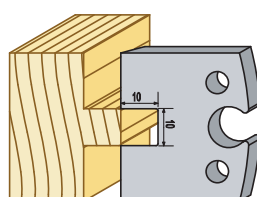

■ 94328HSS

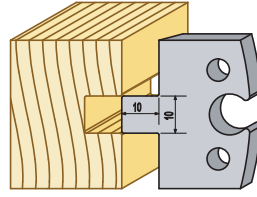

■ 94329HSS

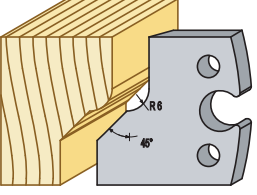

■ 94331HSS

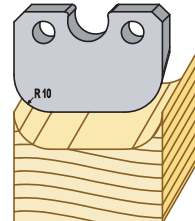

■ 94332HSS

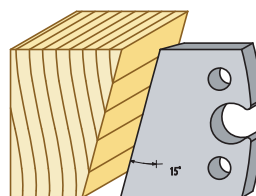

■ 94333HSS

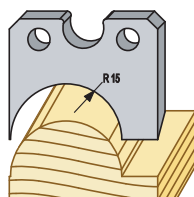

■ 94334HSS

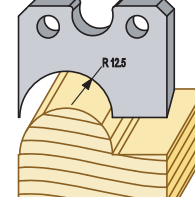

■ 94335HSS

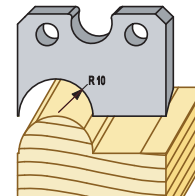

■ 94336HSS

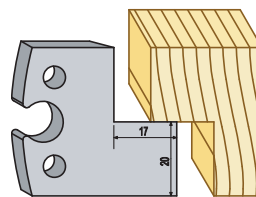

■ 94337HSS

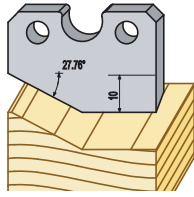

■ 94338HSS

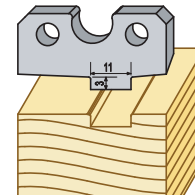

■ 94339HSS

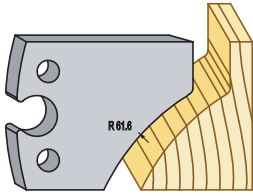

■ 94349HSS

Framtagen för Solohyveln

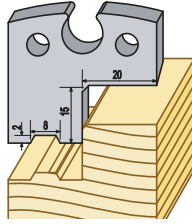

■ 94357HSS

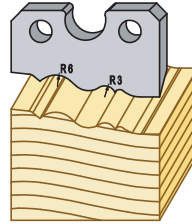

■ 94365HSS

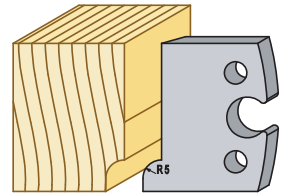

■ 94340HSS

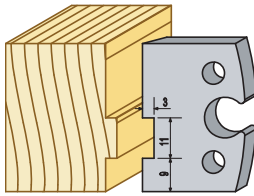

■ 94350HSS

Framtagen för Solohyveln

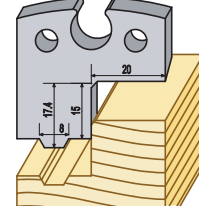

■ 94358HSS

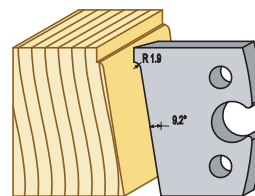

■ 94366HSS

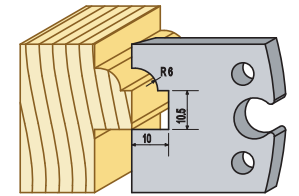

■ 94341HSS

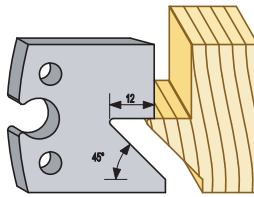

■ 94351HSS

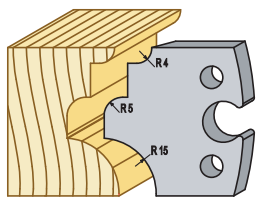

■ 94359HSS

Profildjup 5 mm

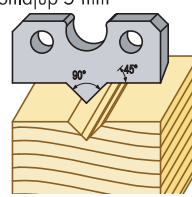

■ 94367HSS

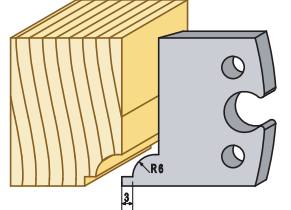

■ 94342HSS

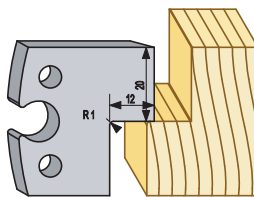

■ 94352HSS

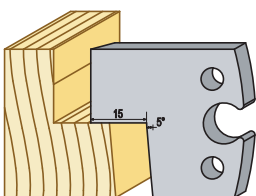

■ 94360HSS

Profildjup 10 mm

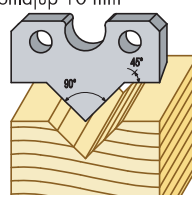

■ 94368HSS

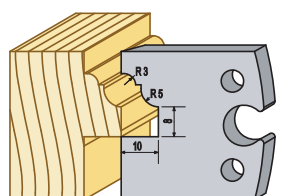

■ 94343HSS

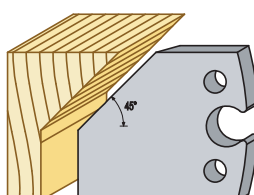

■ 94353HSS

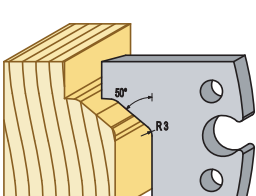

■ 94361HSS

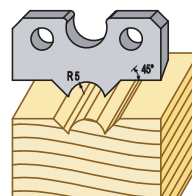

■ 94369HSS

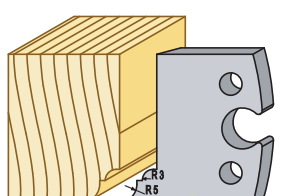

■ 94345HSS

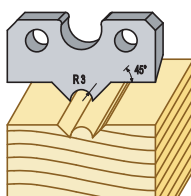

■ 94354HSS

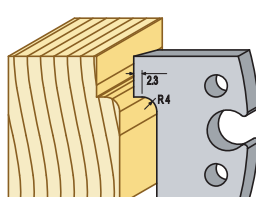

■ 94362HSS

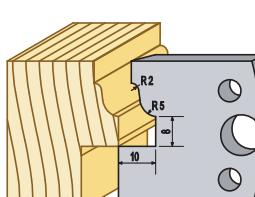

■ 94370HSS

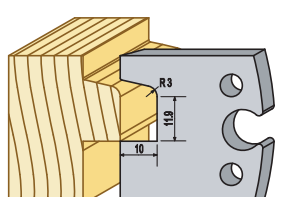

■ 94347HSS

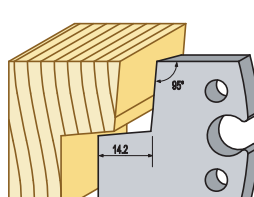

■ 94355HSS

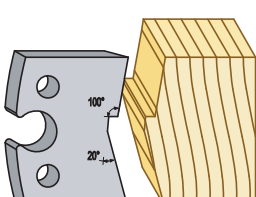

■ 94363HSS

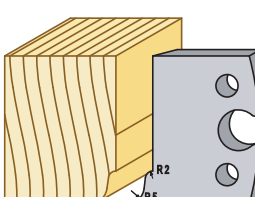

■ 94371HSS

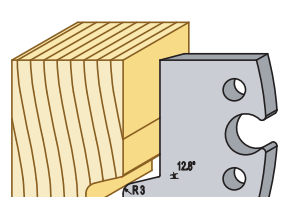

■ 94348HSS

Framtagen för Solohyveln

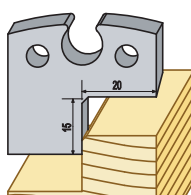

■ 94356HSS

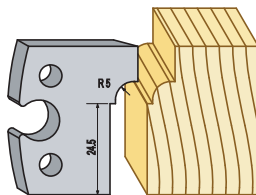

■ 94364HSS

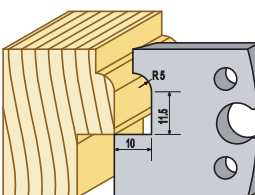

■ 94372HSS

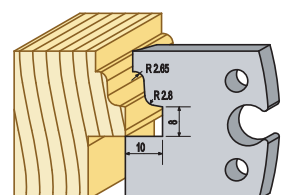

■ 94373HSS

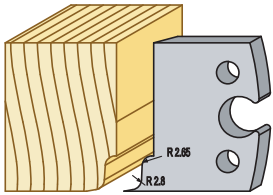

■ 94374HSS

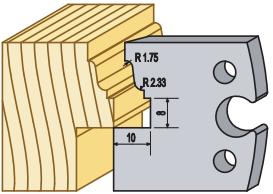

■ 94375HSS

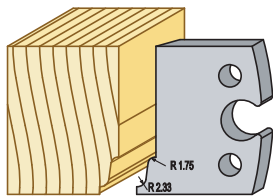

■ 94376HSS

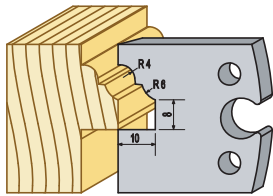

■ 94377HSS

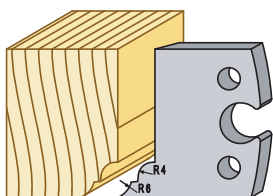

■ 94378HSS

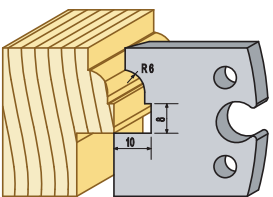

■ 94379HSS

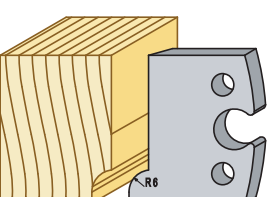

■ 94380HSS

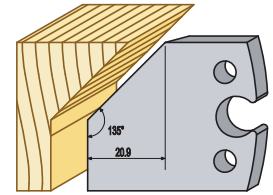

■ 94381HSS

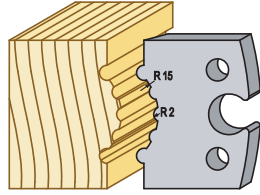

■ 94382HSS

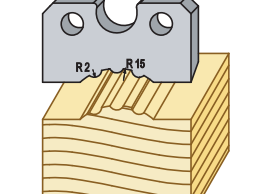

■ 94383HSS

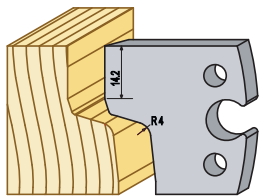

50 mm

■ 9500-20HSS

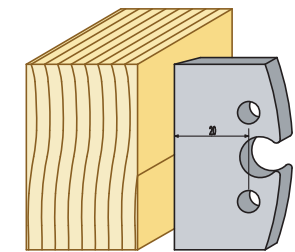

Finns även i 9500-16, 9500-24, 9500-32

■ 95001HSS

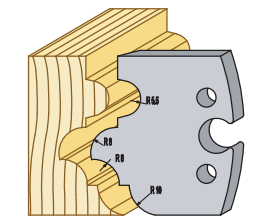

■ 95002HSS

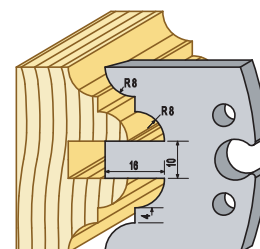

■ 95003HSS

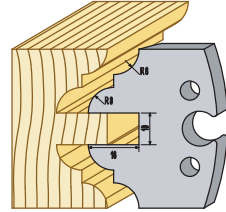

■ 95004HSS

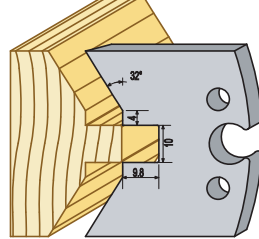

■ 95005HSS

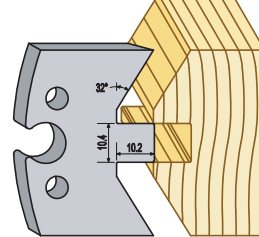

■ 95006HSS

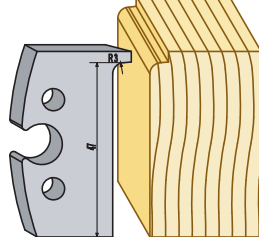

■ 95007HSS

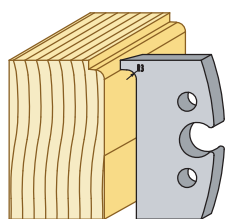

■ 95008HSS

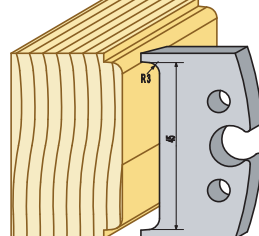

■ 95009HSS

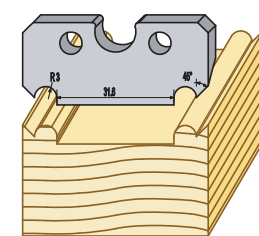

■ 95010HSS

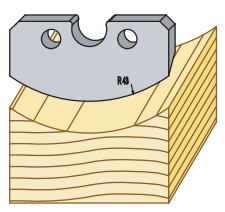

■ 95011HSS

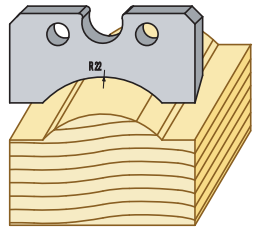

■ 95012HSS

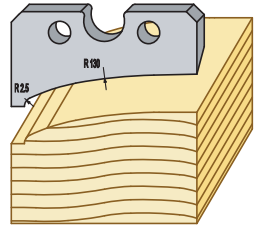

■ 95013HSS

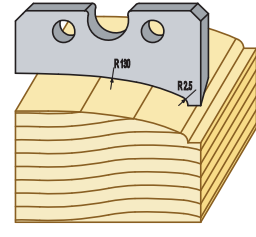

■ 95014HSS

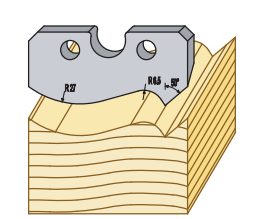

■ 95015HSS

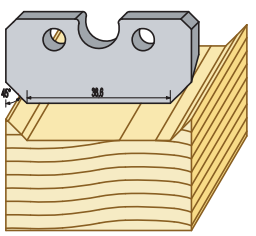

■ 95016HSS

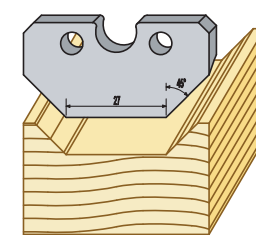

■ 95017HSS

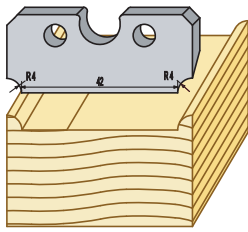

■ 95018HSS

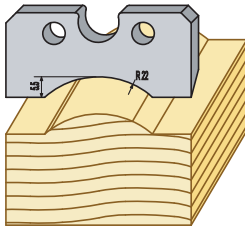

■ 95019HSS

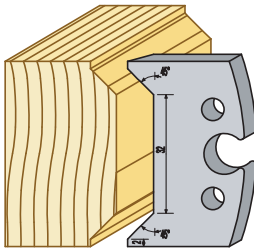

■ 95020HSS

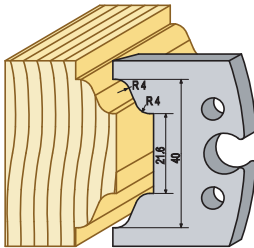

■ 95021HSS

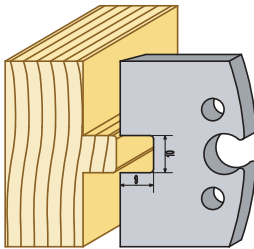

■ 95022HSS

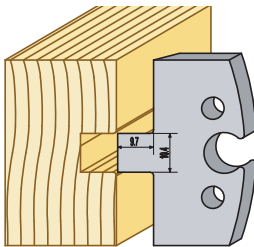

■ 95023HSS

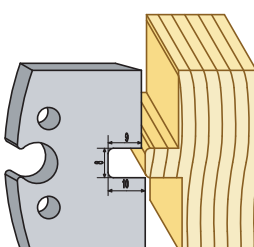

■ 95024HSS

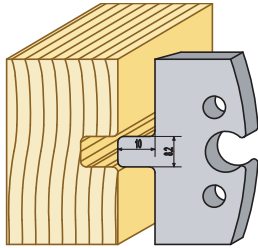

■ 95025HSS

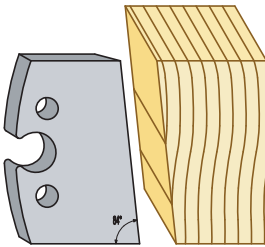

■ 95026HSS

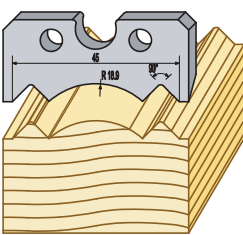

■ 95027HSS

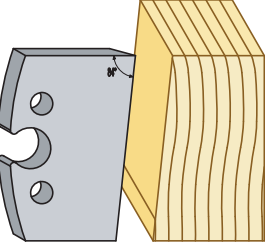

■ 95028HSS

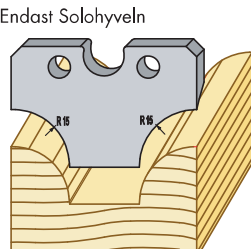

■ 95029HSS

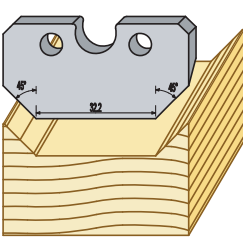

■ 95030HSS

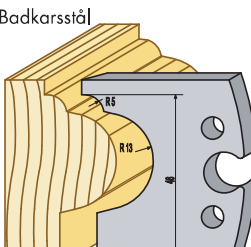

■ 95031HSS

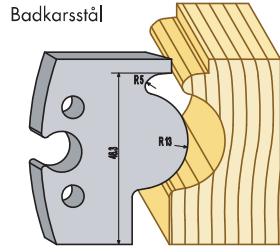

■ 95032HSS

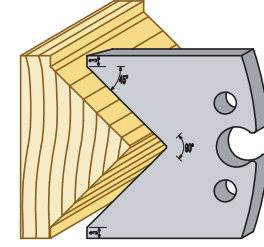

■ 95033HSS

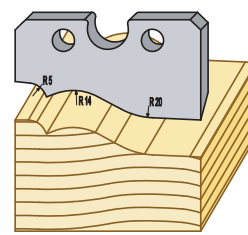

■ 95034HSS

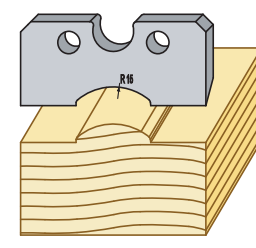

■ 95035HSS

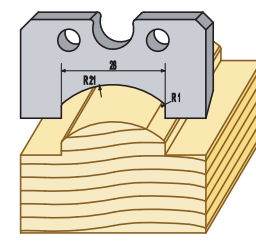

■ 95036HSS

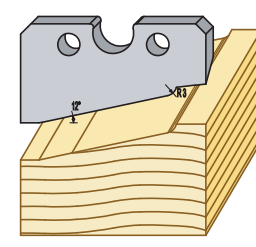

■ 95038HSS

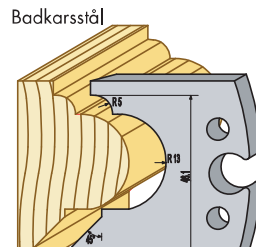

■ 95039HSS

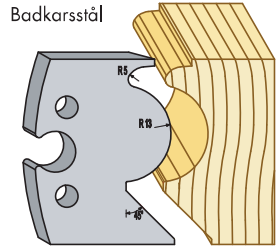

■ 95040HSS

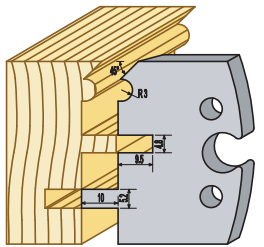

■ 95041HSS

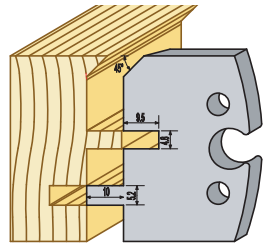

■ 95042HSS

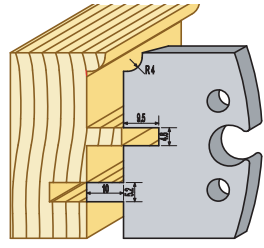

■ 95043HSS

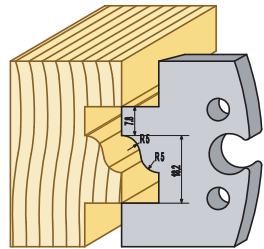

■ 95044HSS

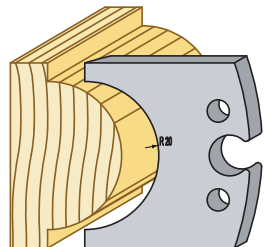

■ 95045HSS

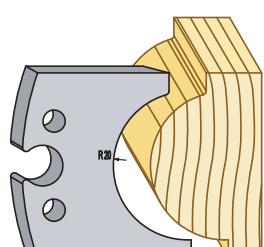

■ 95046HSS

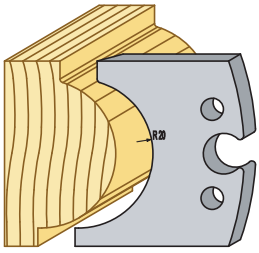

■ 95047HSS

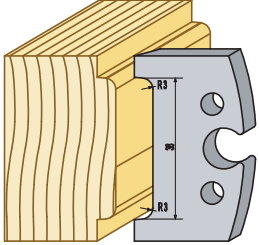

■ 95048HSS

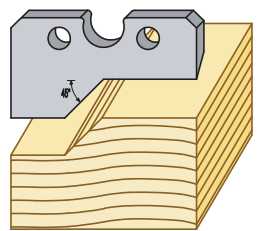

■ 95049HSS

Badkarsstål

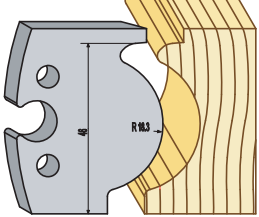

■ 95050HSS

Badkarsstål

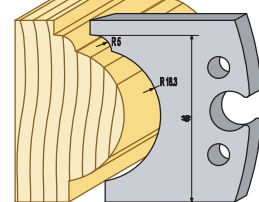

■ 95051HSS

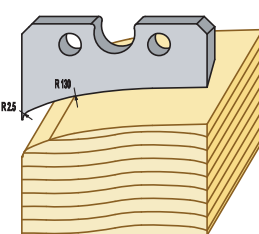

■ 95052HSS

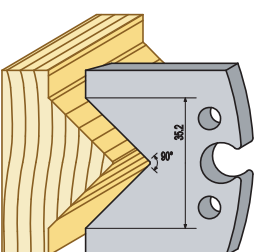

■ 95053HSS

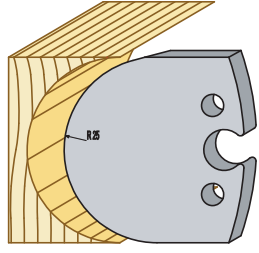

■ 95054HSS

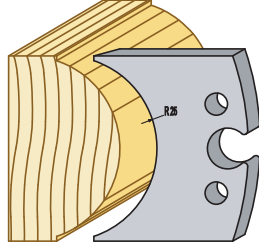

■ 95055HSS

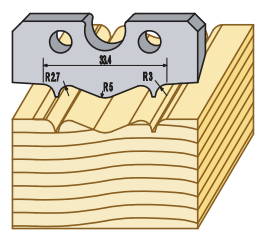

■ 95056HSS

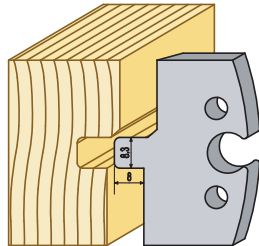

■ 95057HSS

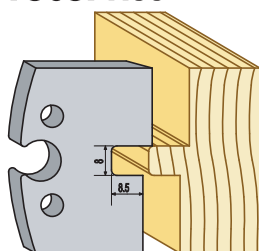

■ 95058HSS

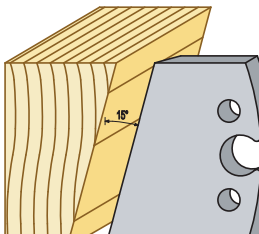

■ 95059HSS

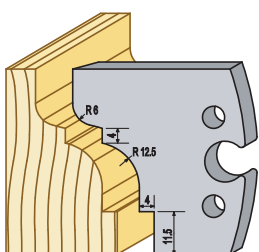

■ 95060HSS

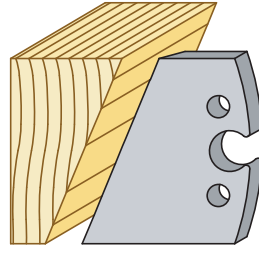

■ 95061HSS

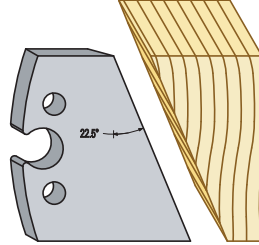

■ 95062HSS

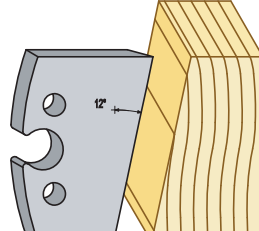

■ 95063HSS

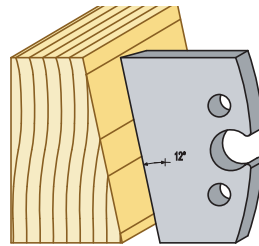

■ 95064HSS

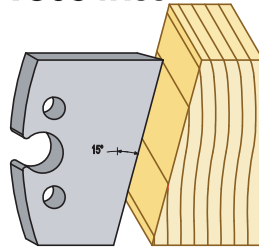

■ 95065HSS

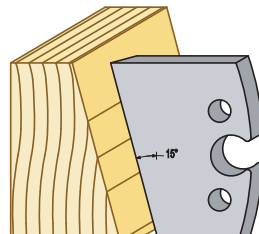

■ 95066HSS

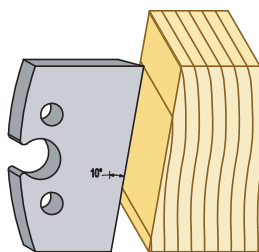

■ 95067HSS

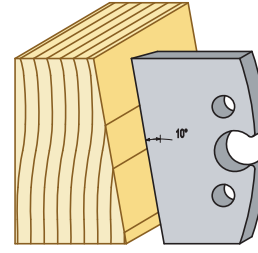

■ 95069HSS

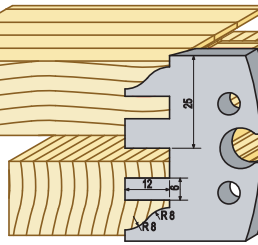

■ 95070HSS

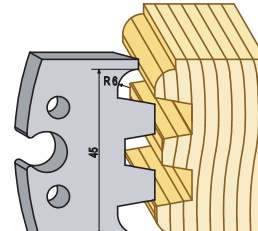

■ 95071HSS

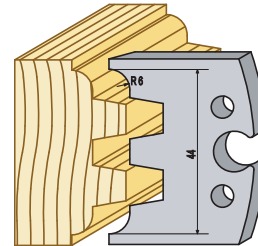

■ 95072HSS

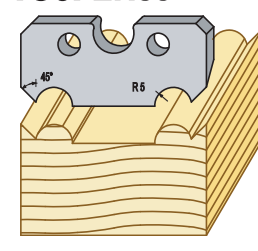

■ 95073HSS

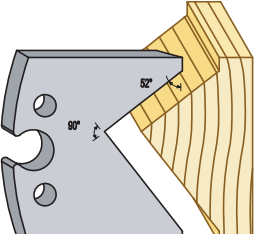

■ 95074HSS

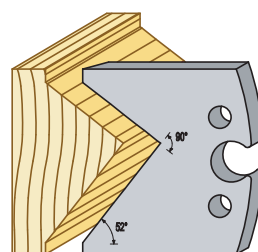

95075HSS

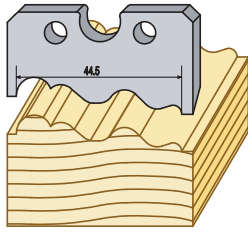

95076HSS

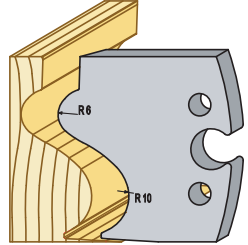

95077HSS

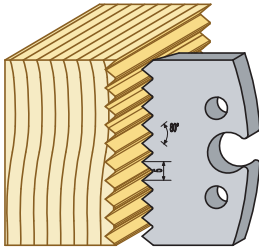

95078HSS

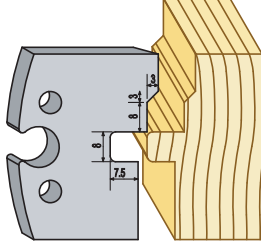

95079HSS

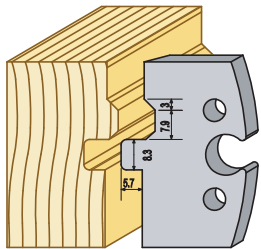

95080HSS

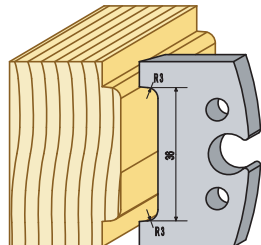

95082HSS

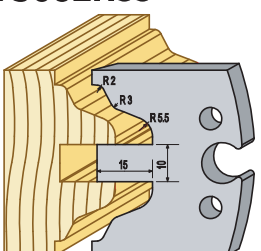

95083HSS

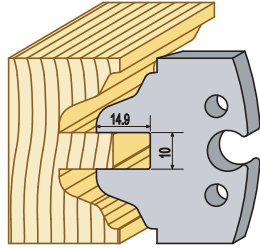

60 mm

9600-20HSS

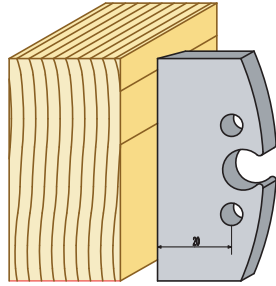

Finns även i 9600-16, 9600-24, 9600-32

96001HSS

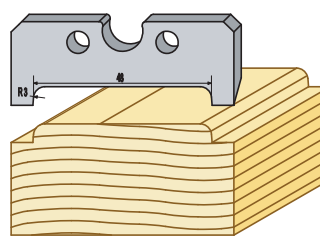

96002HSS

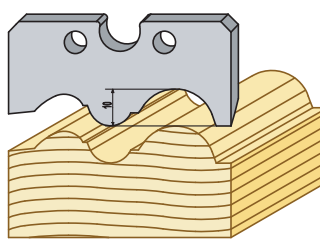

96003HSS

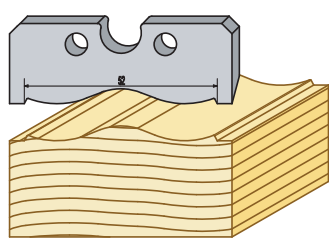

96004HSS

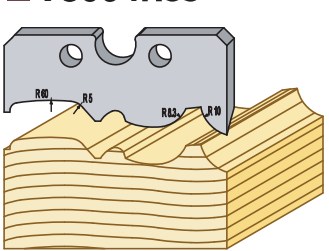

96005HSS

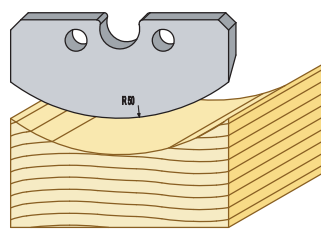

96006HSS

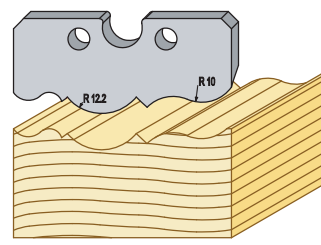

96007HSS

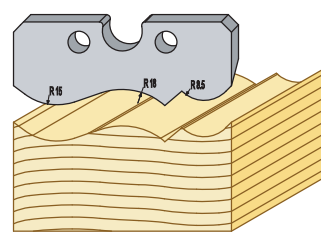

96008HSS

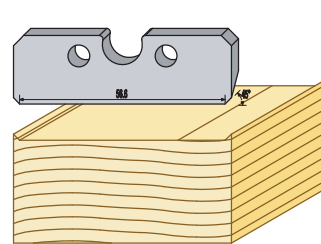

96009HSS

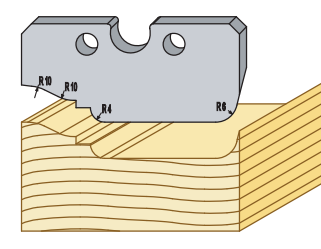

96010HSS

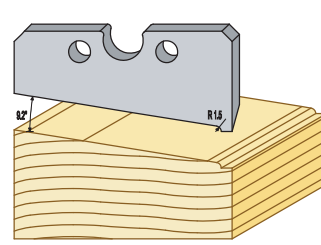

96011HSS

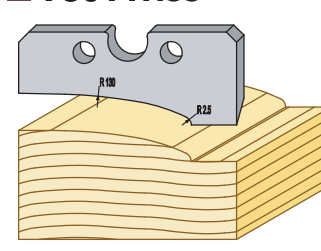

96014HSS

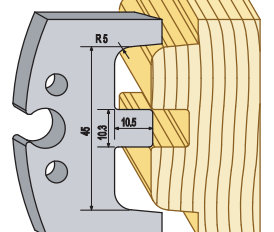

96015HSS

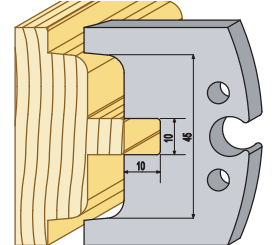

96017HSS

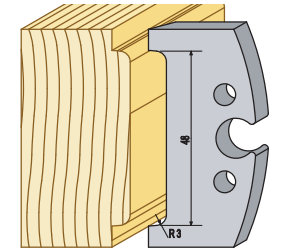

96018HSS

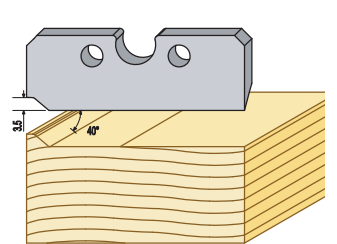

96019HSS

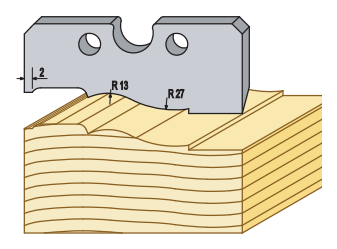

96020HSS

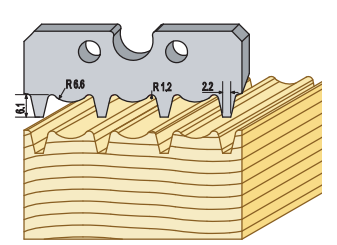

96021HSS

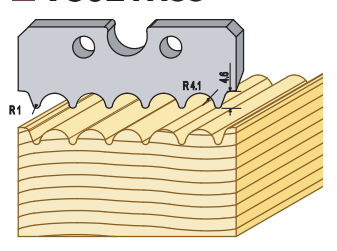

■ 96022HSS

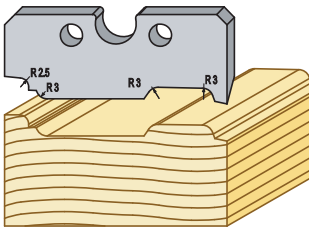

80 mm

■ 98002HSS

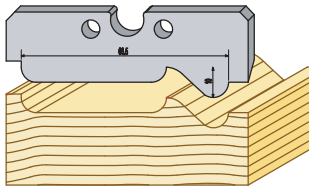

■ 98003HSS

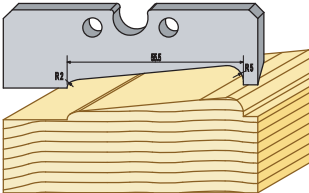

■ 98004HSS

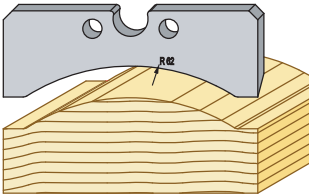

■ 98005HSS

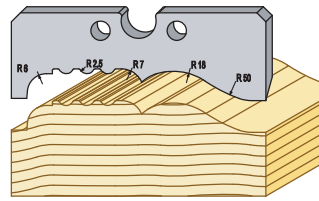

■ 98006HSS

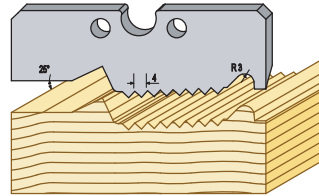

■ 98007HSS

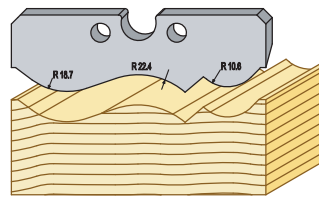

■ 98008HSS

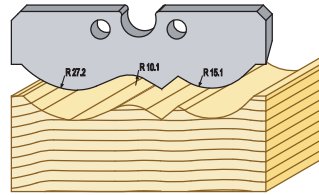

■ 91004HSS

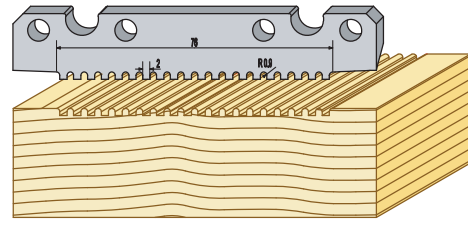

■ 91010HSS Morapanel 95 mm

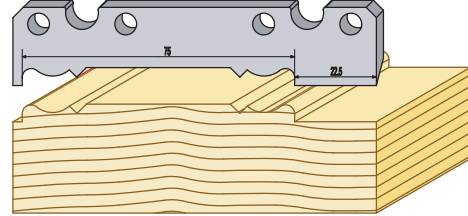

■ 91011HSS Vågig Morapanel 95 mm

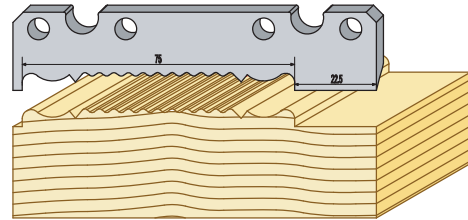

■ 91012HSS Fasadpanel 95 mm

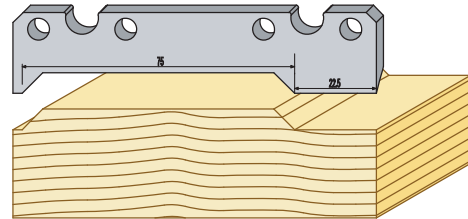

■ 91013HSS Vågig Fasadpanel 95 mm

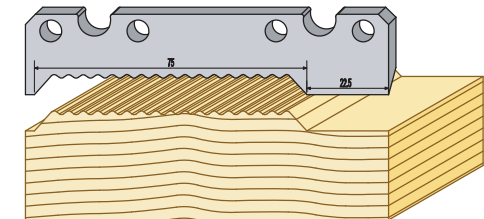

■ 91014HSS Avrundad panel 95 mm

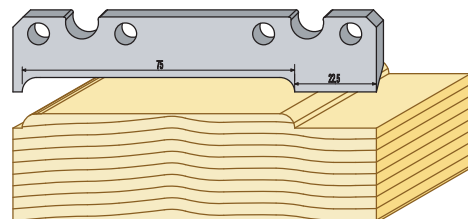

■ 91015HSS Vågig avrundad panel 95 mm

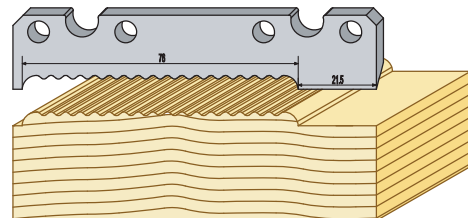

100 mm

■ 91001HSS

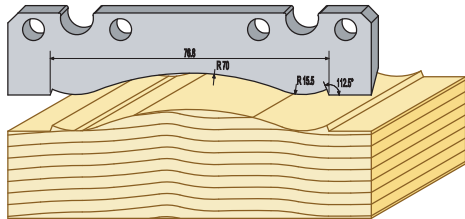

■ 91002HSS

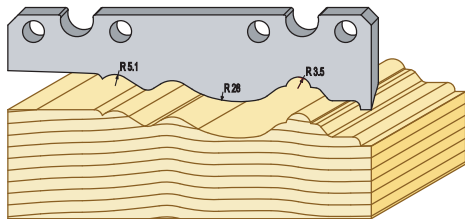

■ 91003HSS

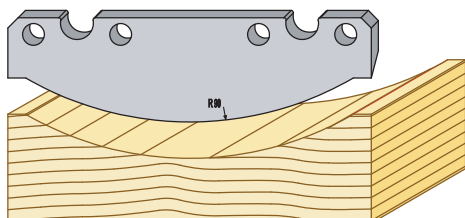

■ **91016HSS** Pärlspont 95 mm

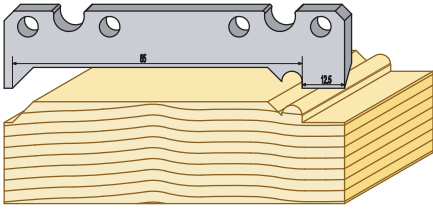

■ **91020HSS**

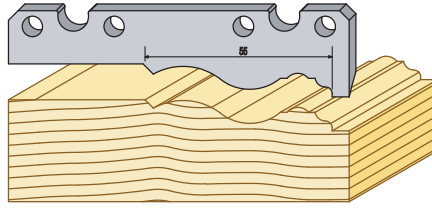

■ **91023HSS**

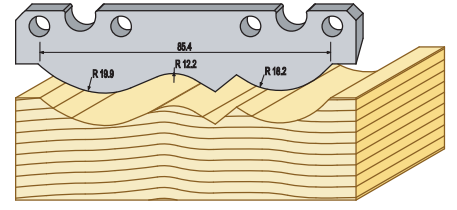

■ **91017HSS** Vågig pärlspont 95 mm

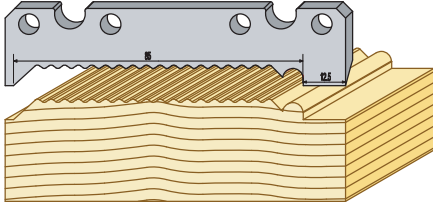

■ **91021HSS**

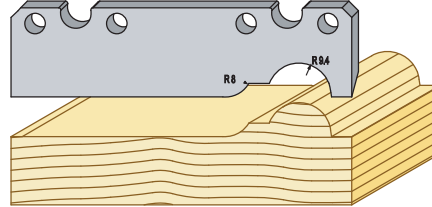

■ **91024HSS**

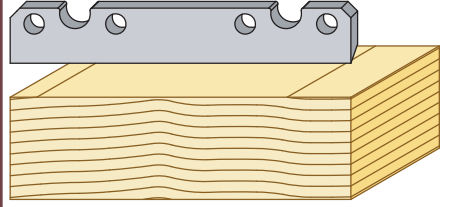

■ **91018HSS** Stockpanel 95 mm

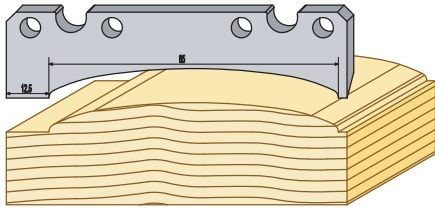

■ **91022HSS**

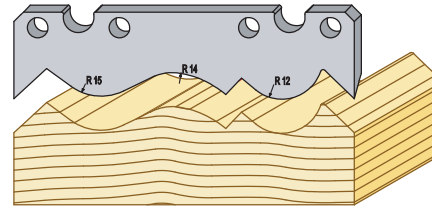

■ **91025HSS**

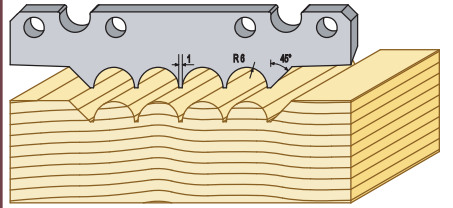

130 mm

■ **91301HSS** Svanhalstaklist

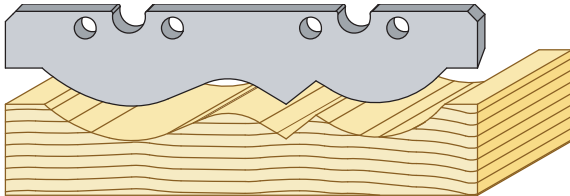

■ **91305HSS**

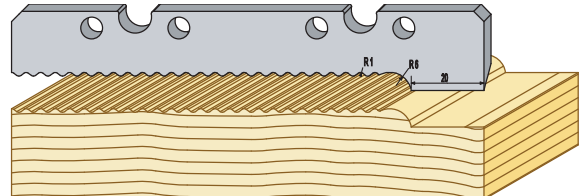

■ **91302HSS**

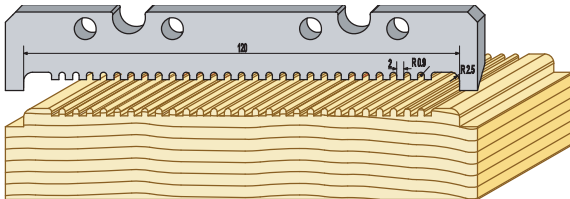

■ **91306HSS**

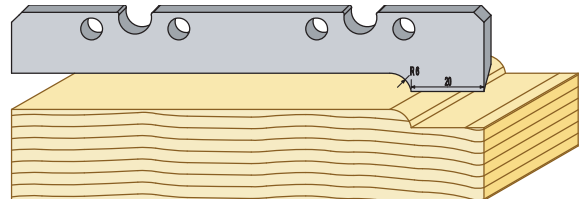

■ **91303HSS**

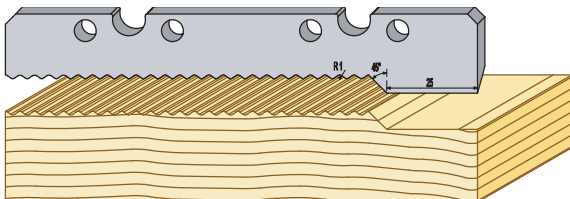

■ **91307HSS**

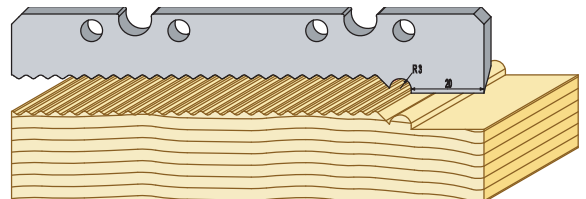

■ **91304HSS**

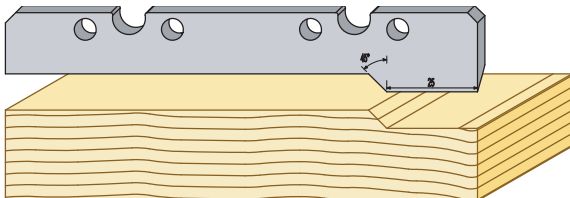

■ **91308HSS**

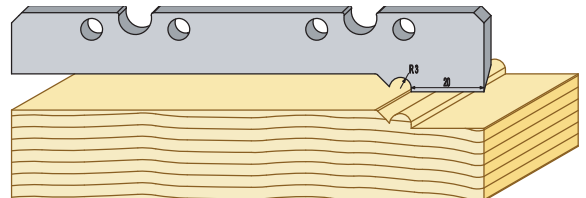

■ **91309HSS**

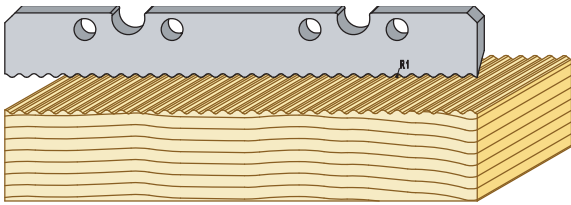

■ **91310HSS** Morapanel 120 mm

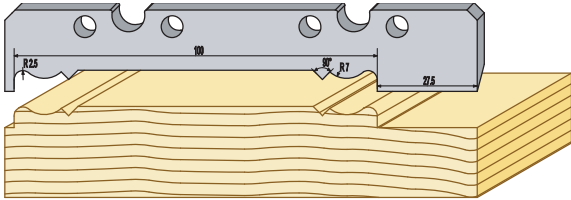

■ **91311HSS** Vågig Morapanel 120 mm

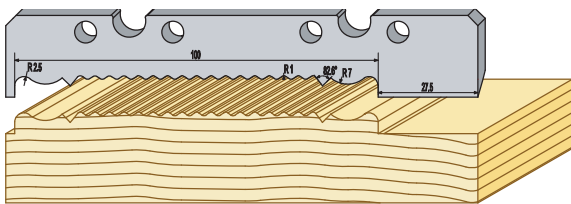

■ **91312HSS** Faspanel 120 mm

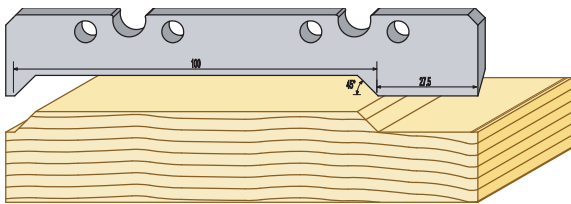

■ **91313HSS** Vågig faspanel 120 mm

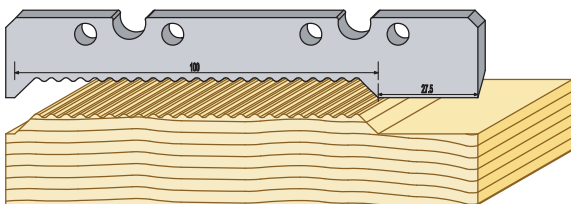

■ **91314HSS** Avrundad panel 120 mm

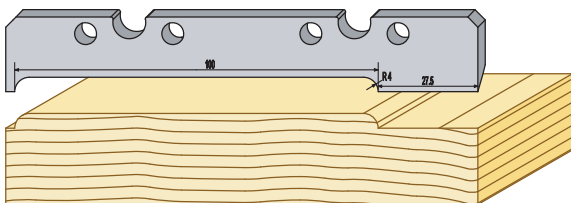

■ **91315HSS** Vågig avrundad panel 120 mm

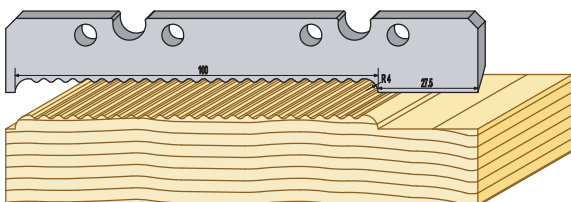

■ **91316HSS** Pärlspont 120 mm

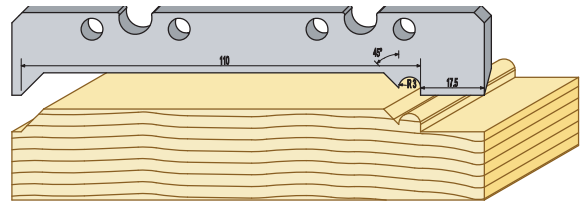

■ **91317HSS** Vågig pärlspont 120 mm

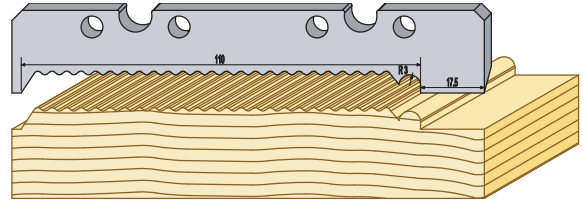

■ **91318HSS** Stockpanel 120mm

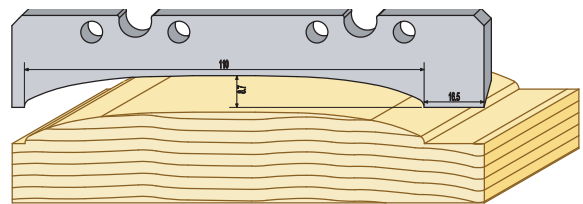

■ **91319HSS** "Sågad" yta

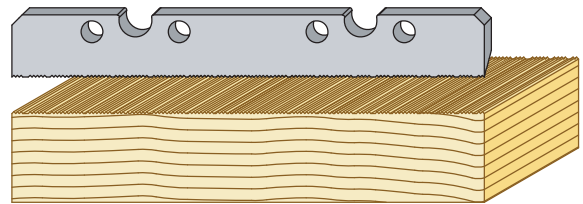

■ **91320HSS**

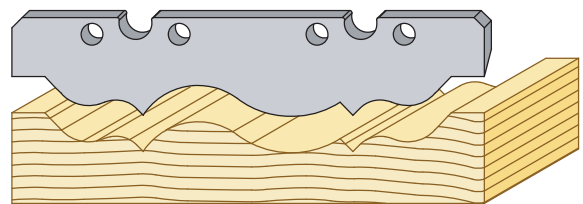

■ **91321HSS**

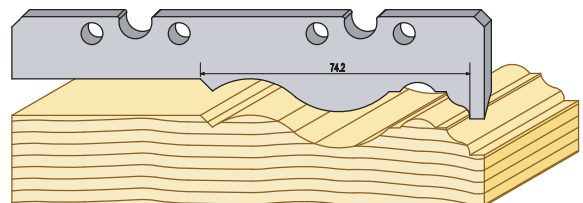

■ **91323HSS**

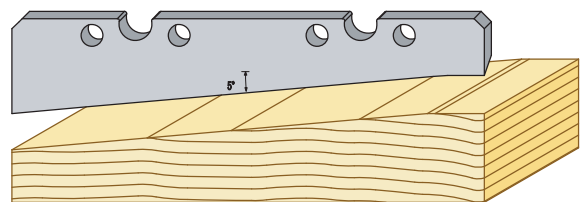

Profilstål i verktygsstål 40 x 4 mm

9000

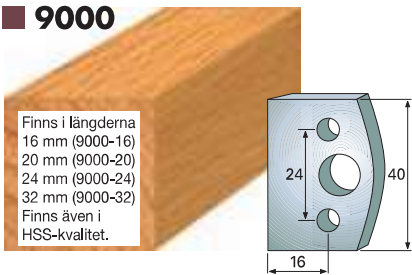

9001

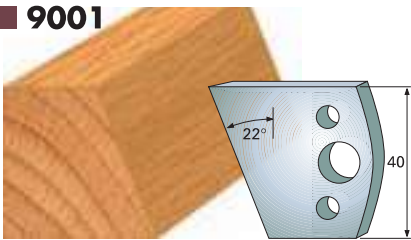

9002

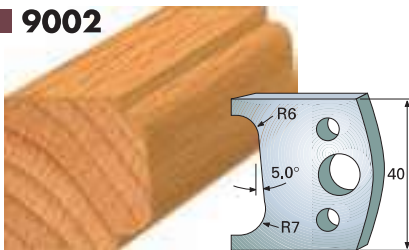

9003

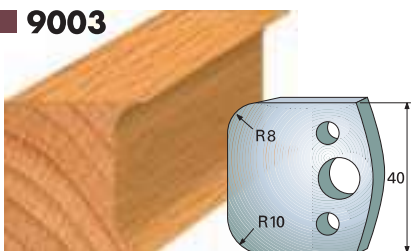

9004

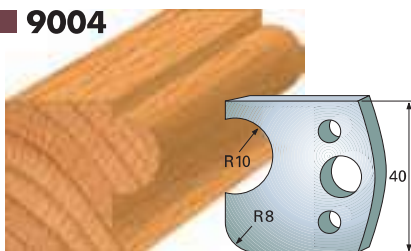

9005

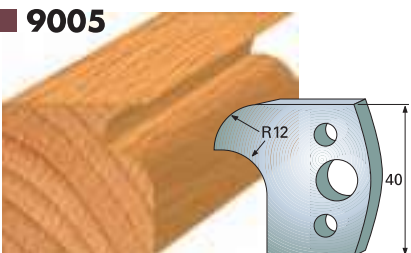

9006

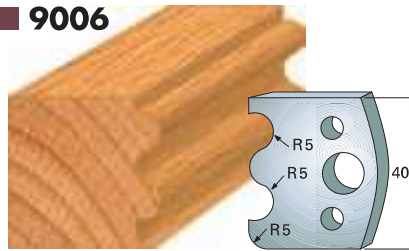

9007

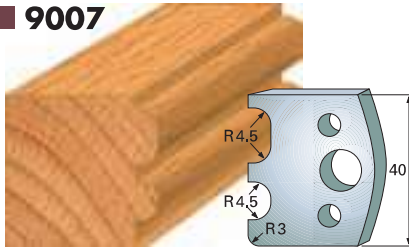

9008

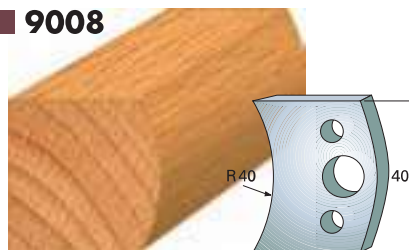

9009

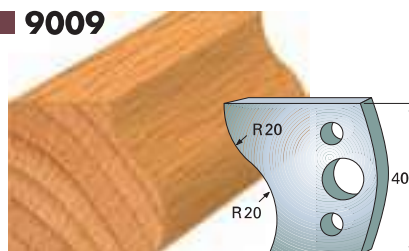

9010

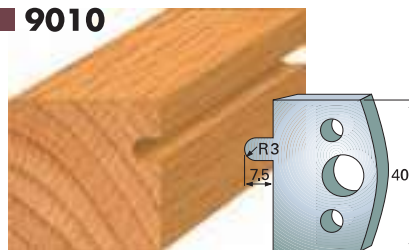

9011

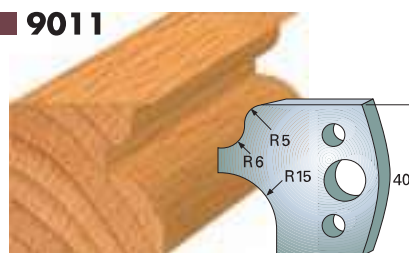

9012

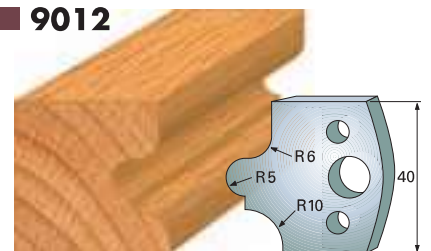

9013

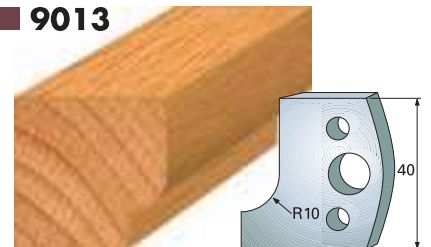

9014

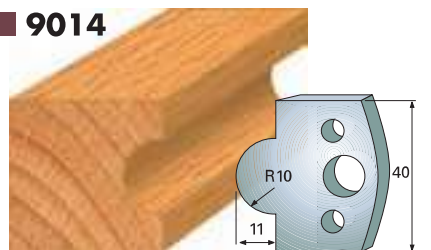

9015

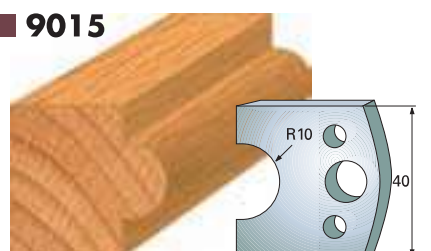

9016

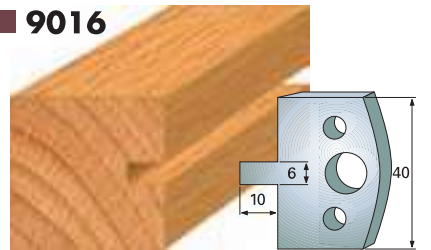

9017

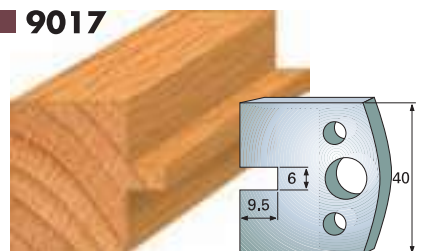

■ 9018

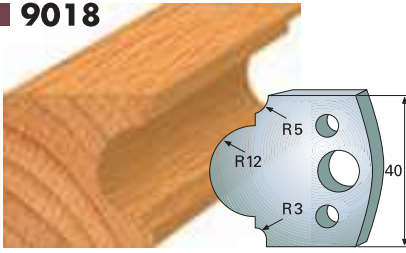

■ 9025

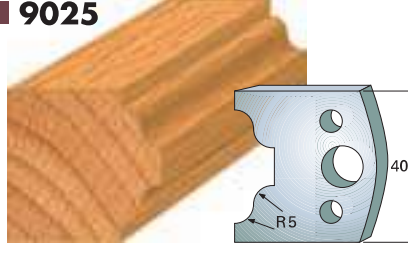

■ 9032

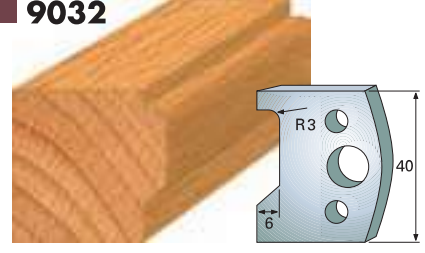

■ 9019

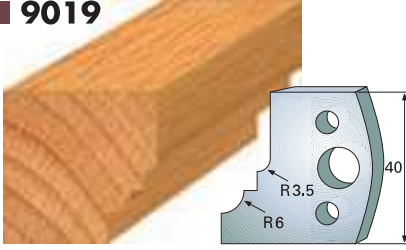

■ 9026

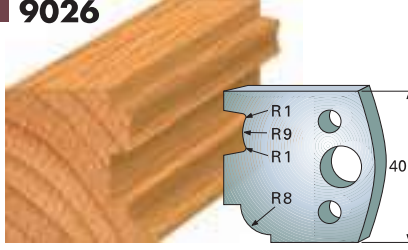

■ 9033

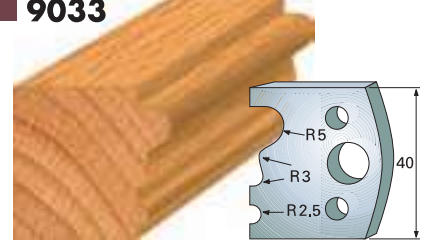

■ 9020

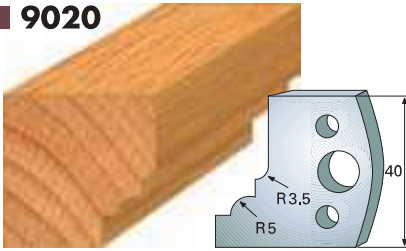

■ 9027

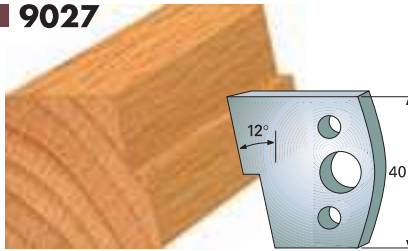

■ 9034

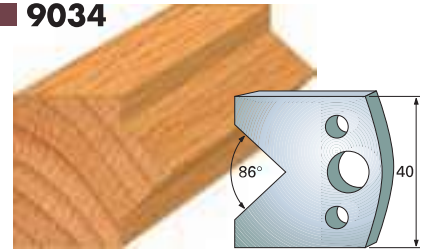

■ 9021

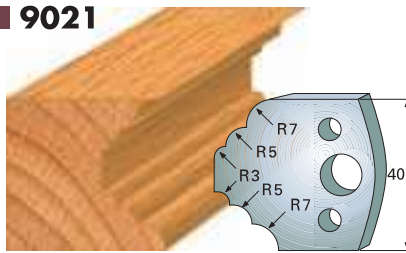

■ 9028



■ 9035

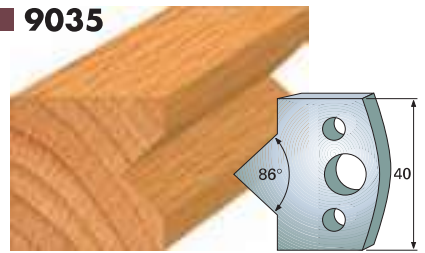

■ 9022

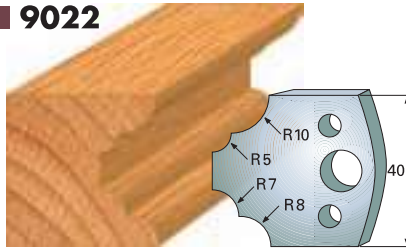

■ 9029

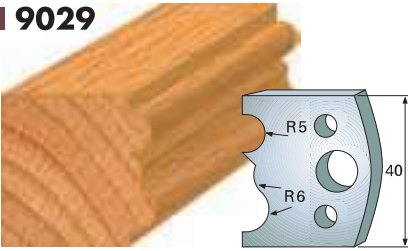

■ 9036

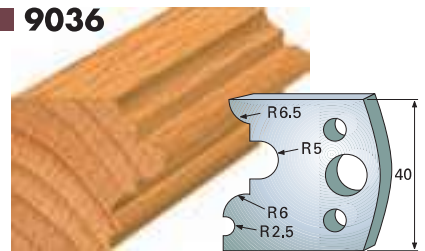

■ 9023

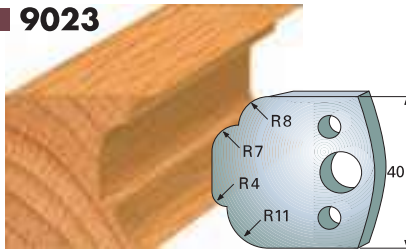

■ 9030

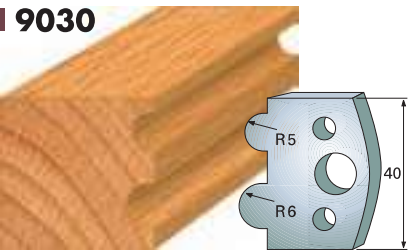

■ 9037

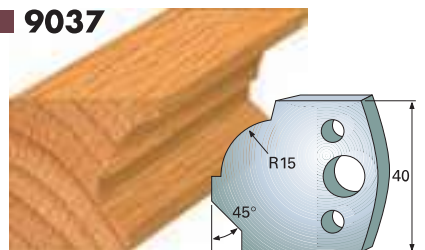

■ 9024

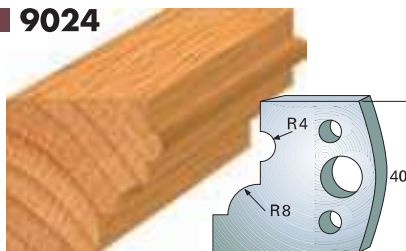

■ 9031

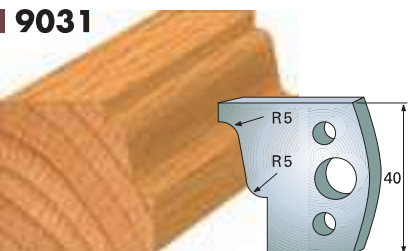

■ 9038

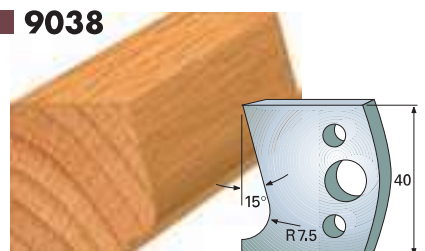

Hittar du inte profilen som passar dig, se specialtillverkning på sidan 135.

■ 9039

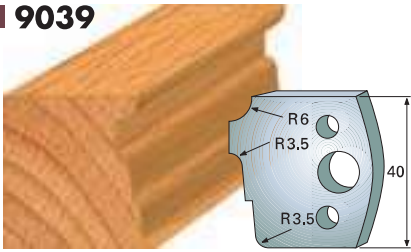

■ 9046

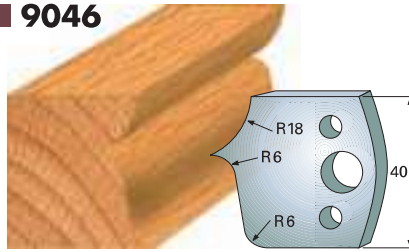

■ 9053

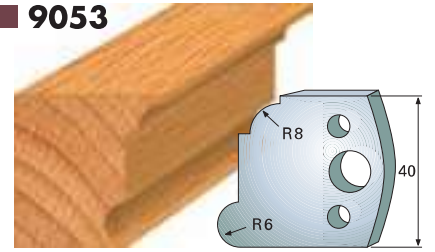

■ 9040

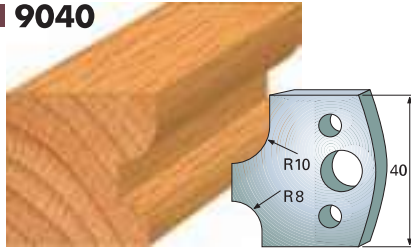

■ 9047

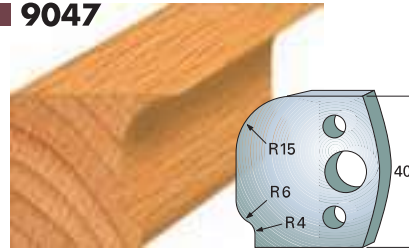

■ 9054

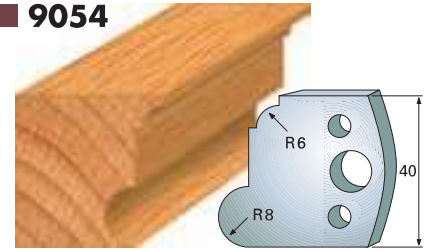

■ 9041

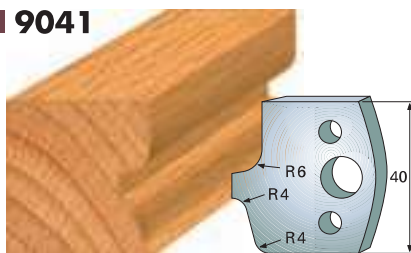

■ 9048

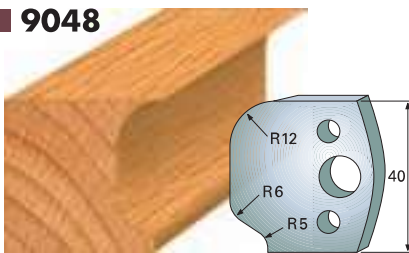

■ 9055

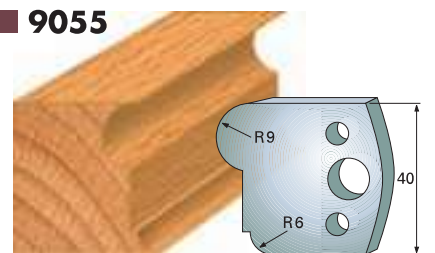

■ 9042

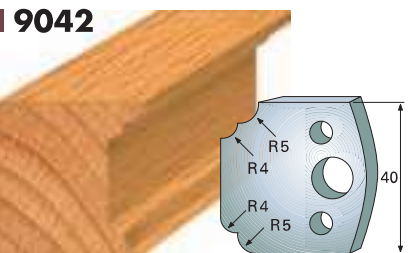

■ 9049

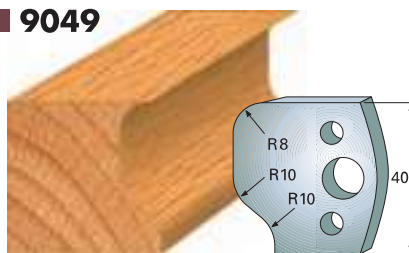

■ 9056

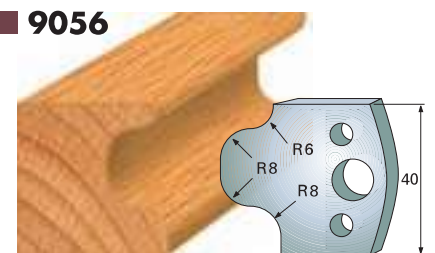

■ 9043

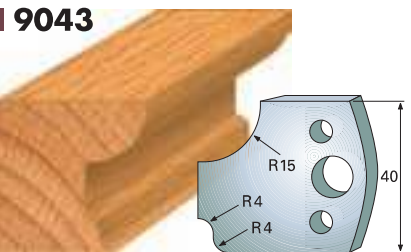

■ 9050

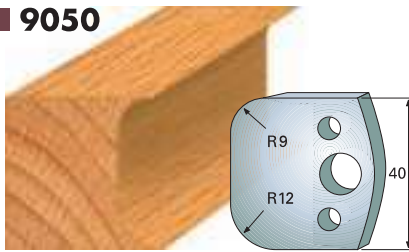

■ 9057

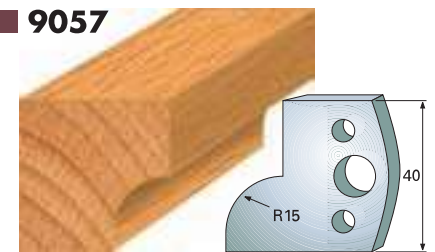

■ 9044

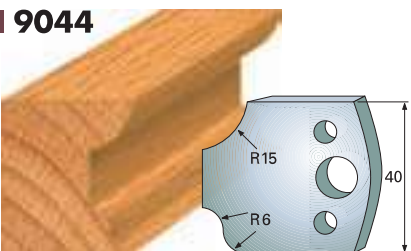

■ 9051

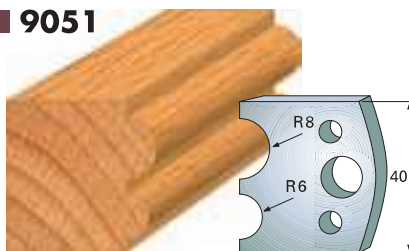

■ 9058

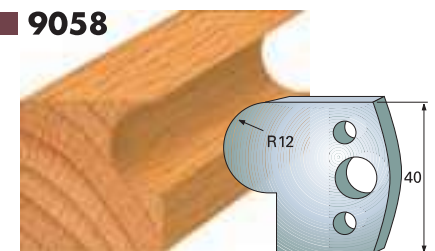

■ 9045

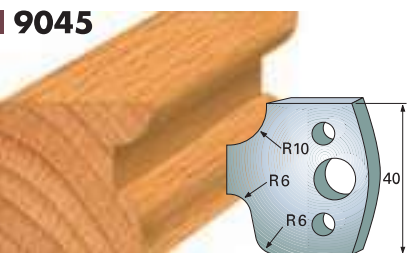

■ 9052

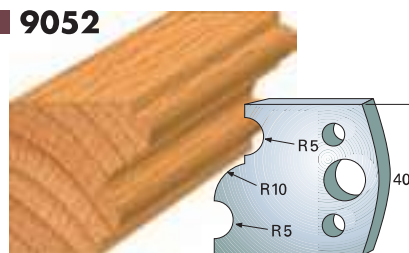

■ 9059

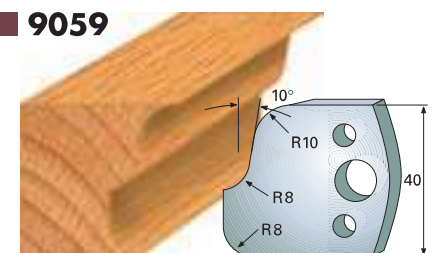

■ 9060

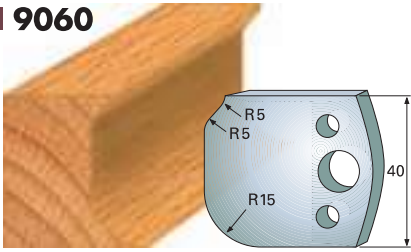

■ 9067

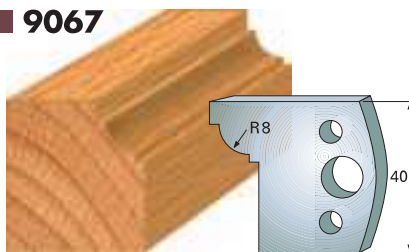

■ 9074

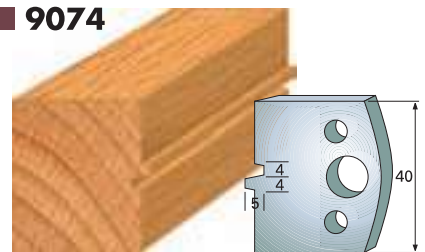

■ 9061

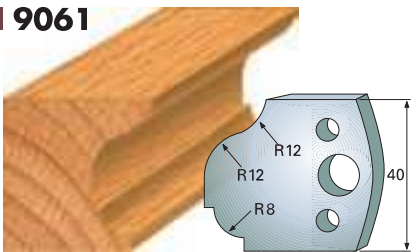

■ 9068

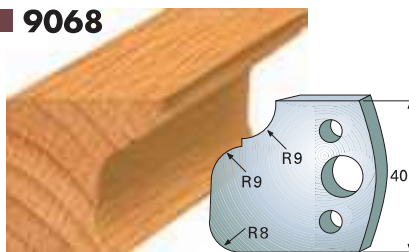

■ 9075

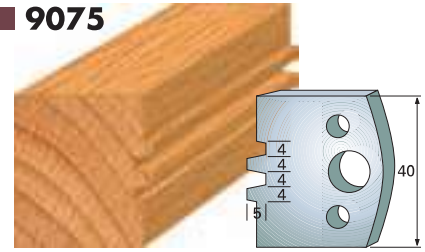

■ 9062

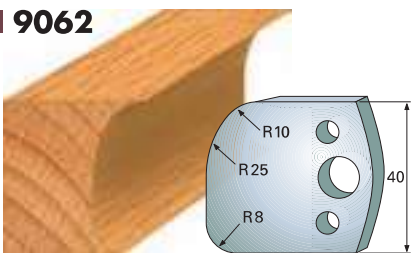

■ 9069

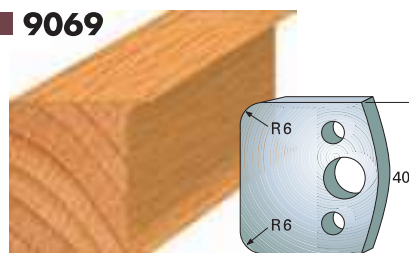

■ 9076

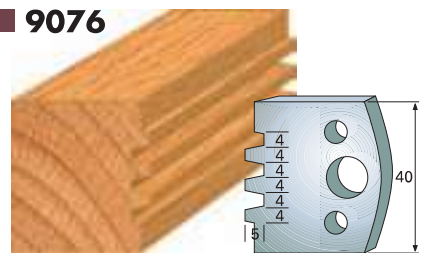

■ 9063

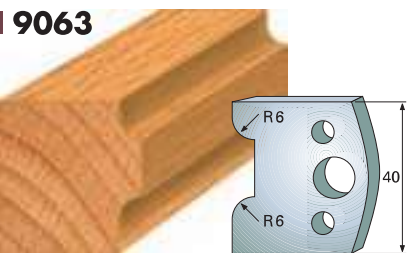

■ 9070

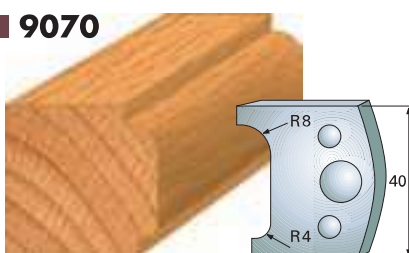

■ 9077

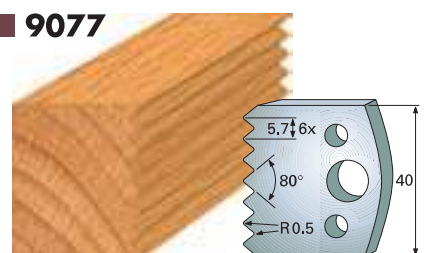

■ 9064

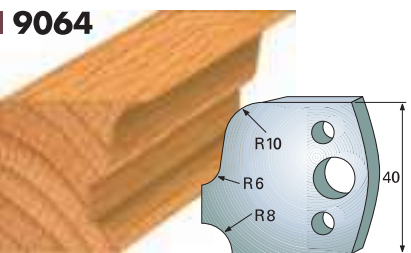

■ 9071

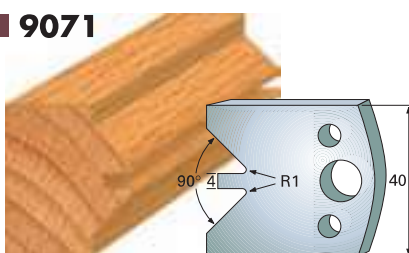

■ 9078

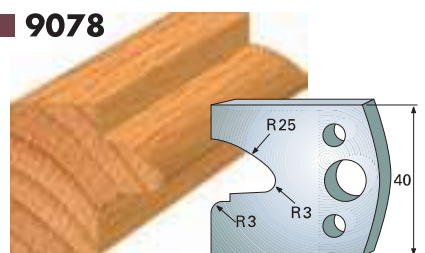

■ 9065

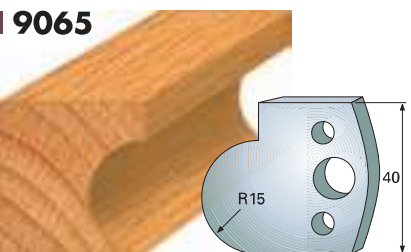

■ 9072

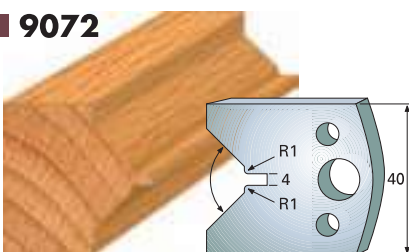

■ 9079

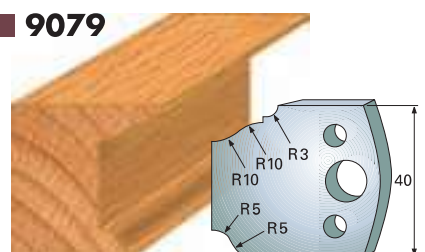

■ 9066

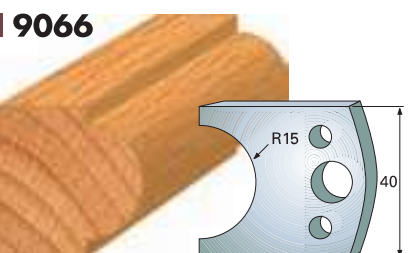

■ 9073

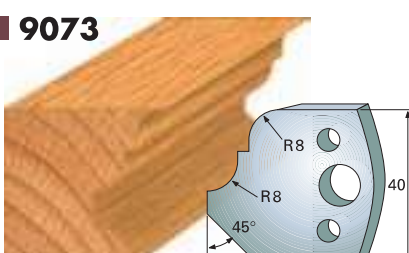

■ 9080

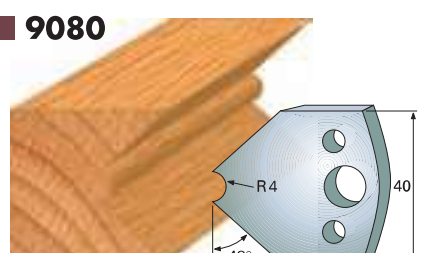

Hittar du inte profilen som passar dig, se specialtillverkning på sidan 135.

9081

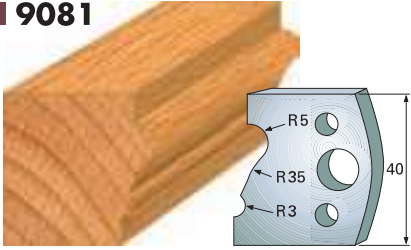

9088

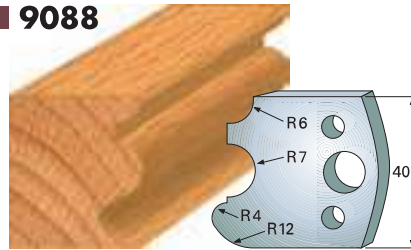

9091-3

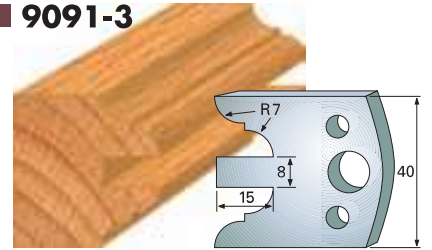

9082

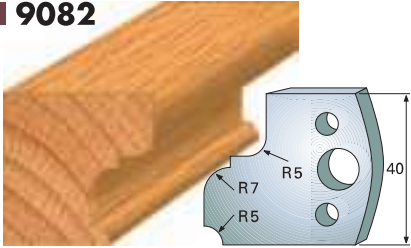

9089

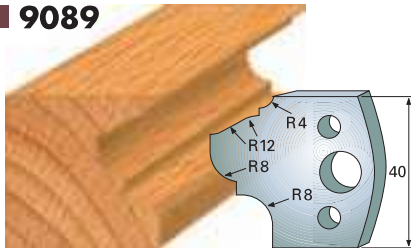

9091-4

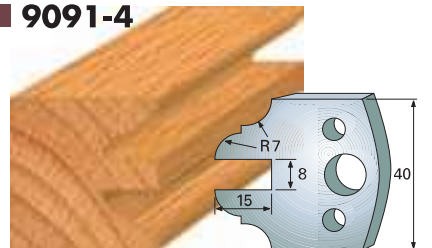

9083

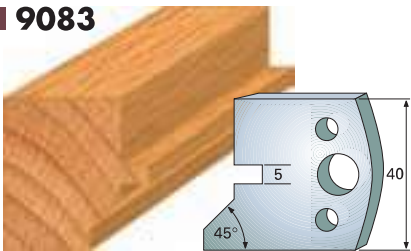

9090

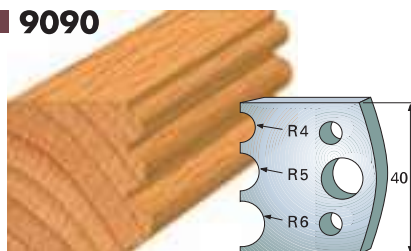

9092

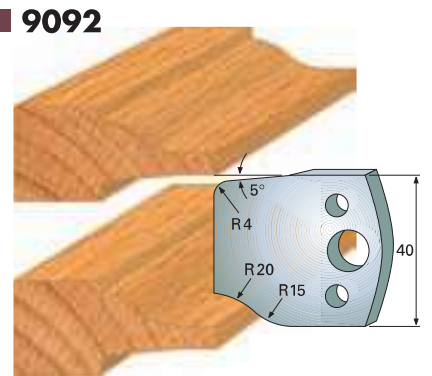

9084

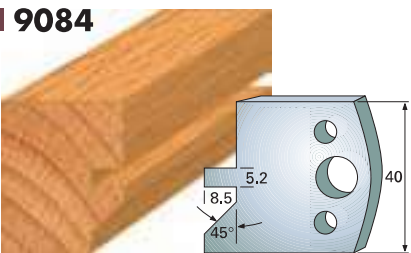

9091-1

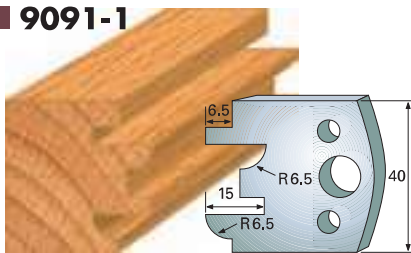

90101

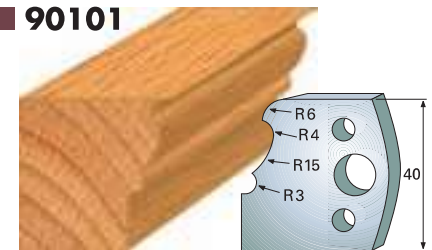

9085

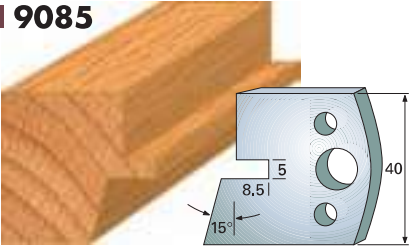

90102

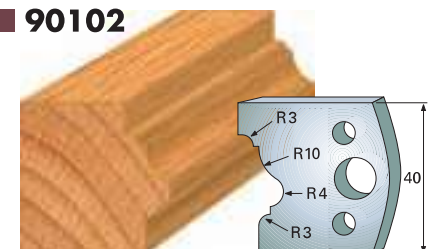

9086

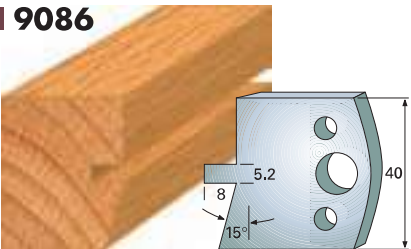

9091-2

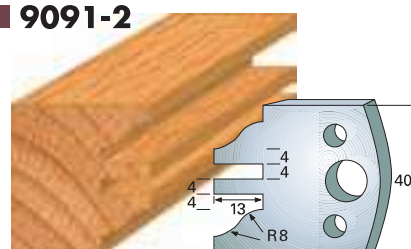

90103

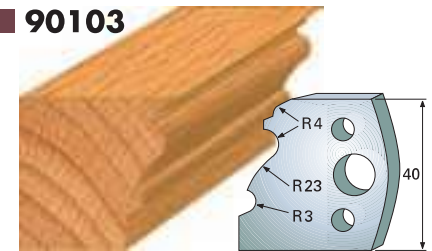

9087

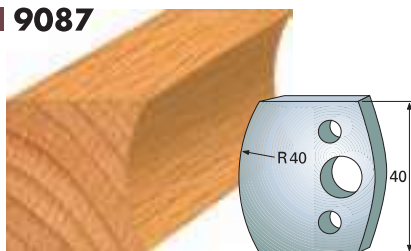

■ 90104

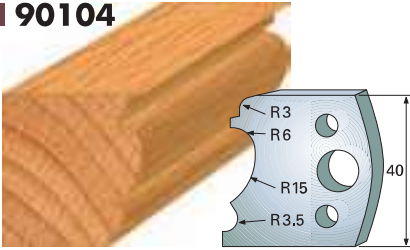

■ 90111

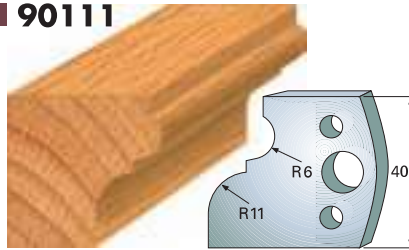

■ 90118

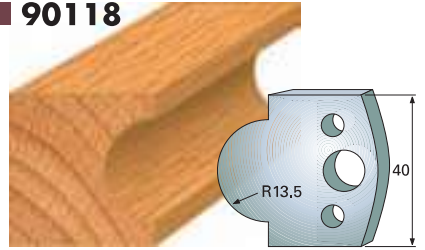

■ 90105

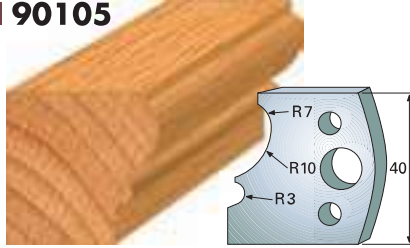

■ 90112

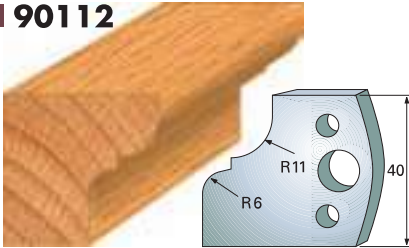

■ 90119

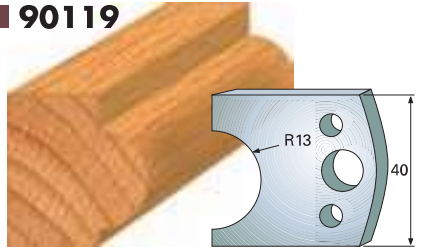

■ 90106

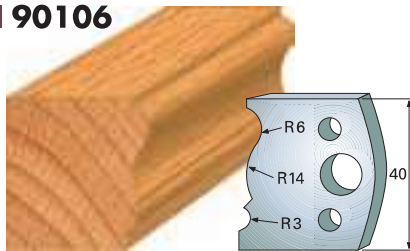

■ 90113

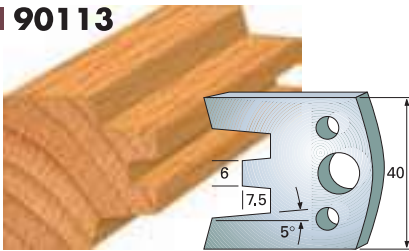

■ 90120

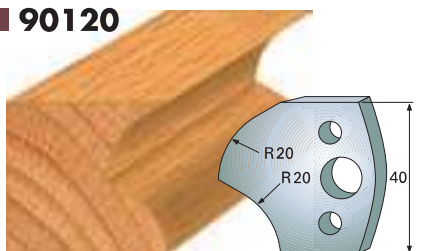

■ 90107

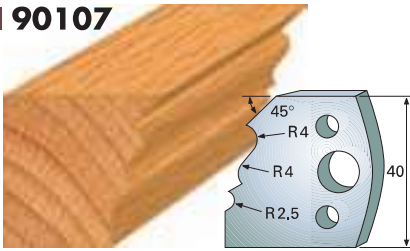

■ 90114

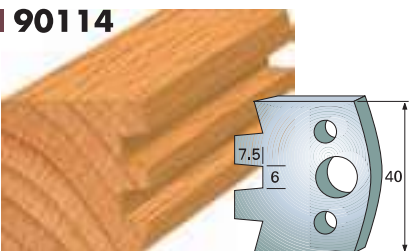

■ 90121



■ 90108

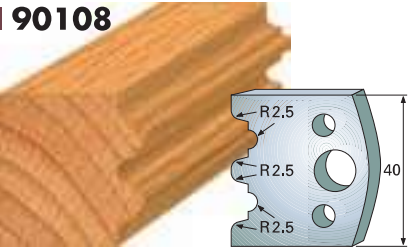

■ 90115

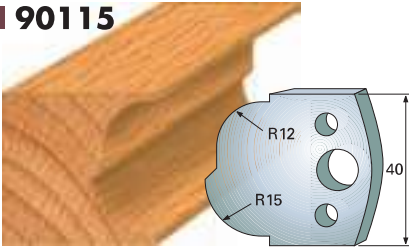

■ 90122

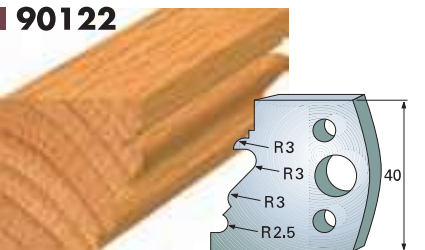

■ 90109

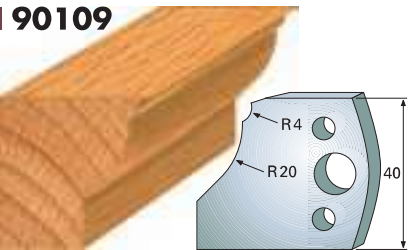

■ 90116

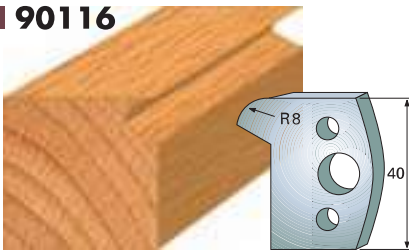

■ 90123

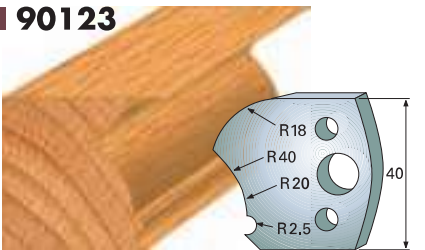

■ 90110

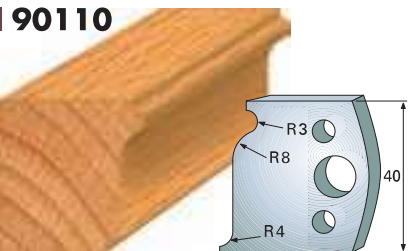

■ 90117

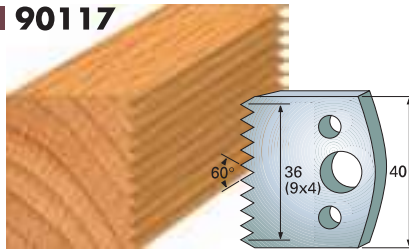

■ 90124

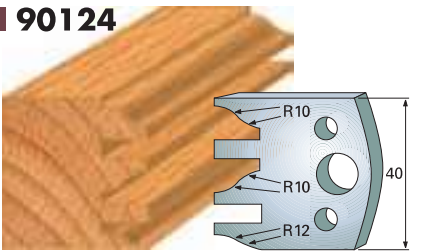

90127

Allmogestål

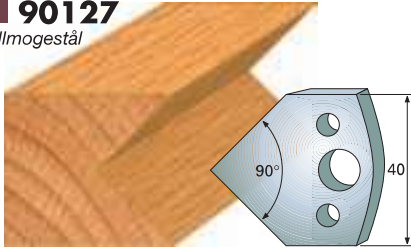
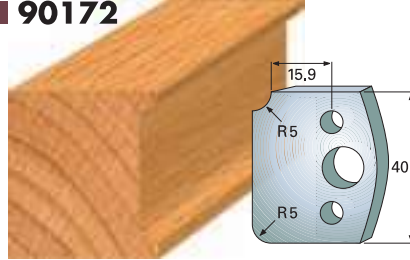
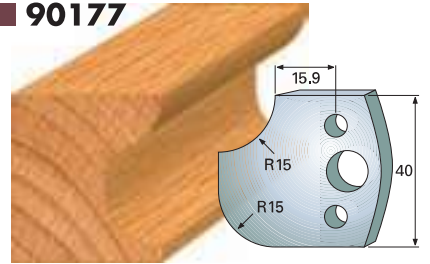
**90172****90177****90128**

Allmogestål

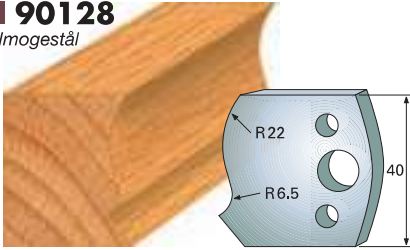
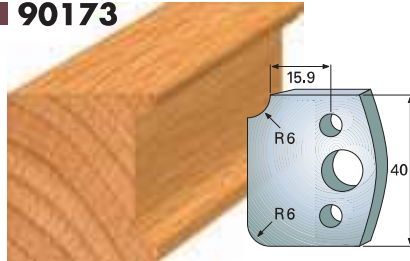
**90173****TB90-Allmoge**

Allmogeprofilstålen (90127, 90128, 90129) som sats



Taklist 52x22 mm



Foder 70x15 mm



Golvlist 95x15 mm

90129

Allmogestål

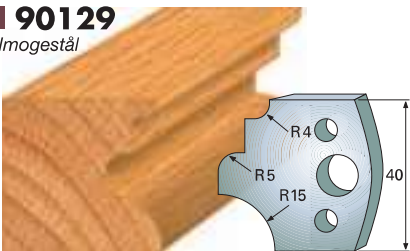
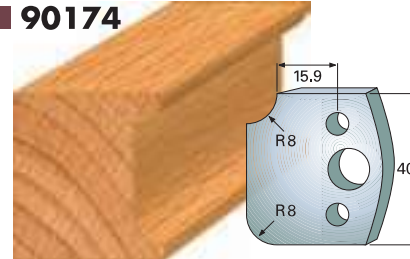
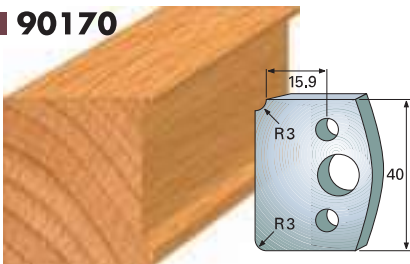
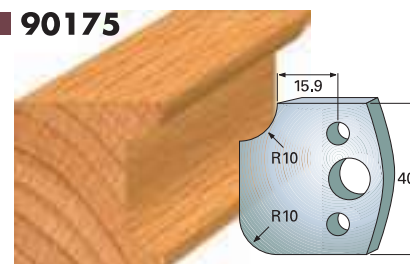
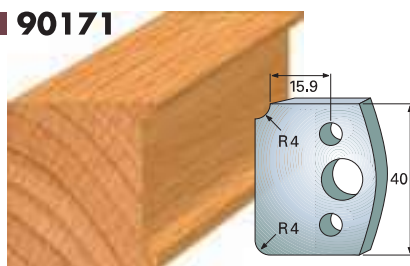
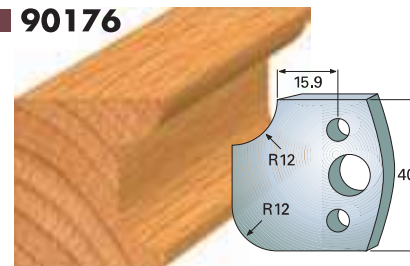
**90174****90170****90175****90171****90176**

Profilstål i verktygsstål 50 x 4 mm

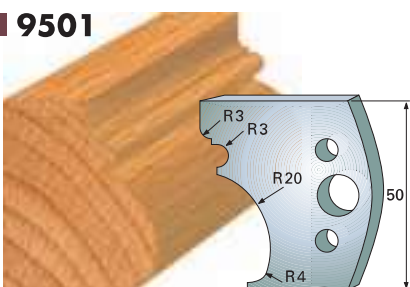
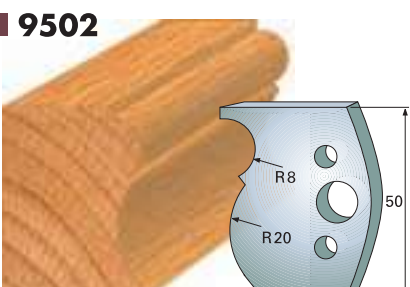
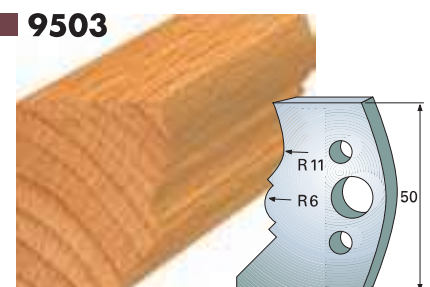
9501**9502****9503**

■ 9504

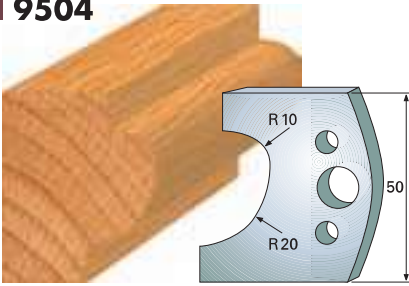

■ 9510

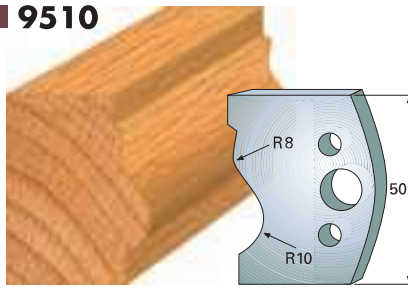

■ 9516

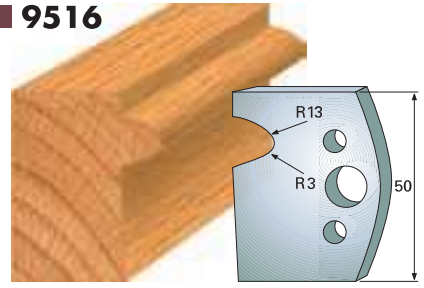

■ 9505

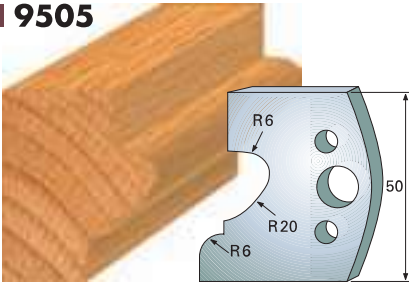

■ 9511

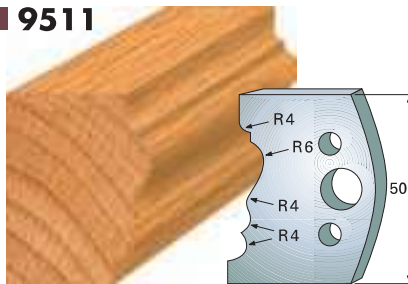

■ 9517

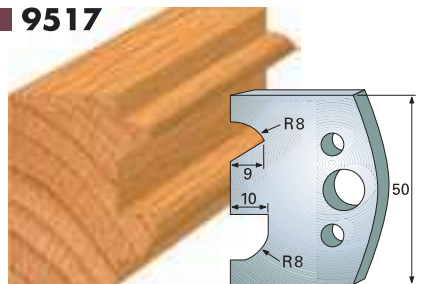

■ 9506

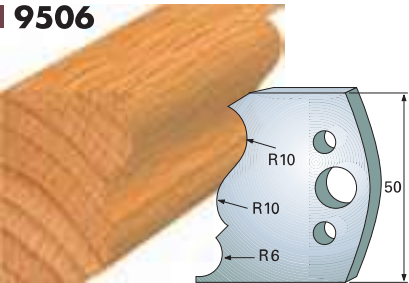

■ 9512

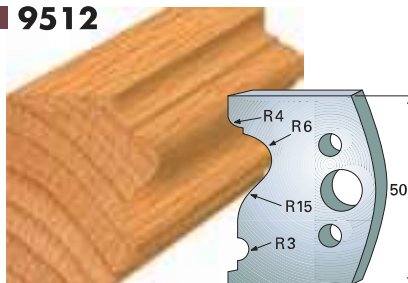

■ 9518

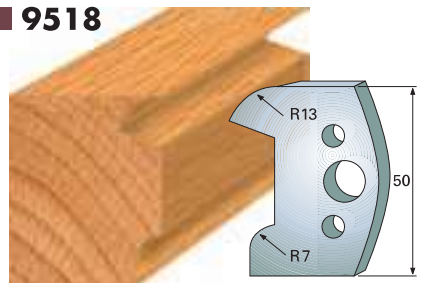

■ 9507

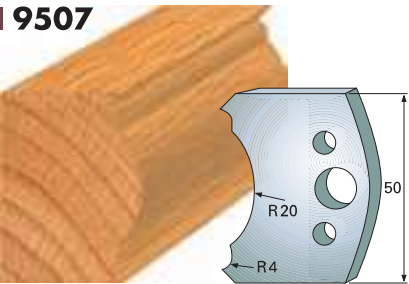

■ 9513

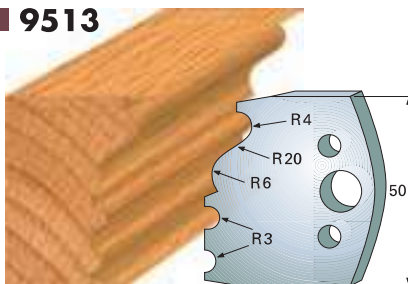

■ 9519

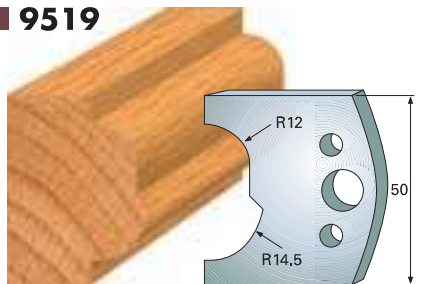

■ 9508

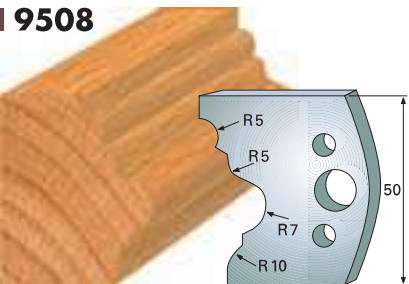

■ 9514

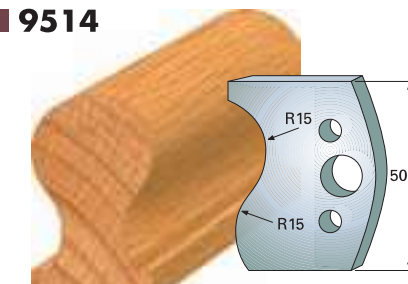

■ 9509

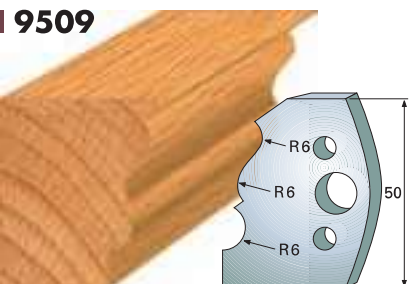

■ 9515

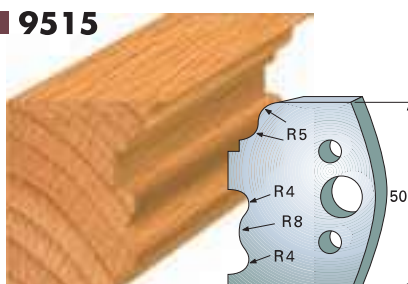

Hittar du inte profilen som passar dig, se specialtillverkning på sidan 135.

Profilstål i verktygsstål 50 x 5,5 mm

■ 95200

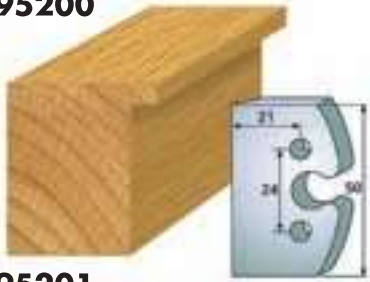

■ 95207

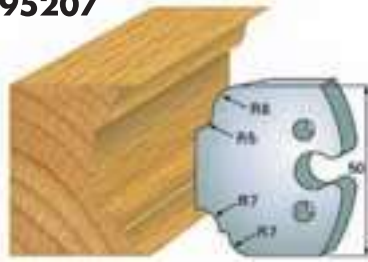

■ 95214



■ 95201

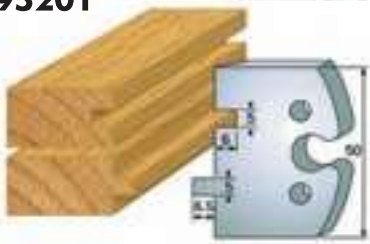

■ 95208

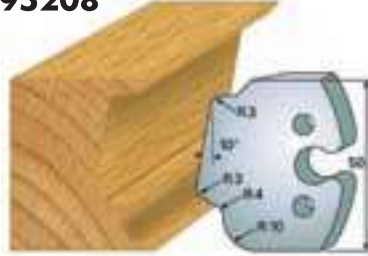

■ 95215



■ 95202

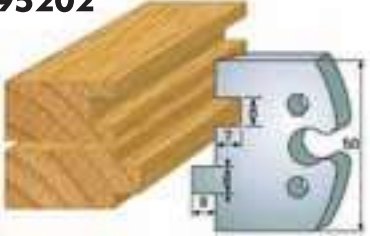

■ 95209

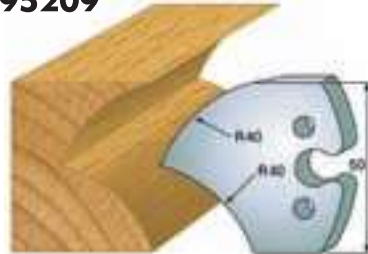

■ 95216



■ 95203



■ 95210



■ 95217

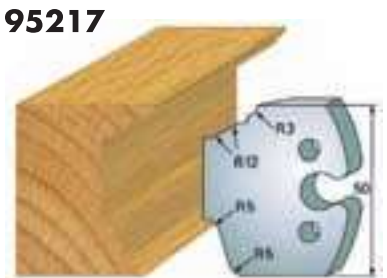

■ 95204



■ 95211



■ 95218



■ 95205

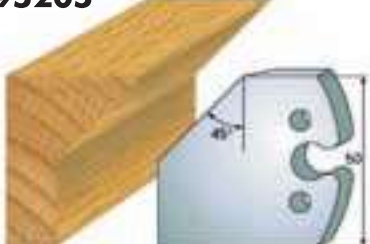

■ 95212



■ 95219



■ 95206



■ 95213



■ 95220



■ 95221



■ 95226



■ 95231

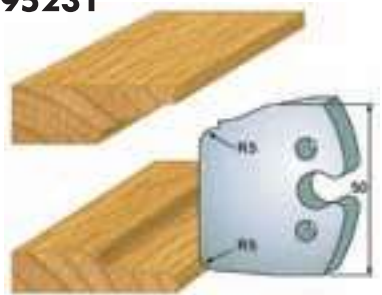

■ 95222



■ 95227



■ 95232



■ 95223



■ 95228



■ 95233



■ 95224



■ 95229



■ 95225



■ 95230



Planstål, 510 mm	
Överkutter MP360, MP365	
1 par	HSS-510



Planstål, 410 mm	
Överkutter MP260, underkutter MP360, MP365	
1 par	HSS-RPH410



Planstål, 300 mm	
Underkutter MP260	
1 par	HSS-PH300



■ 9500-20HSS

Planstål, 50 mm	
Planstål, Sidokutter	
1 par	9500-20HSS

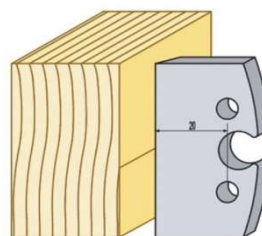

Kutterkil KIL-038	
Kutterkil, Över, underkutter MP260, Underkutter MP280, MP360	
1 par	KIL-038

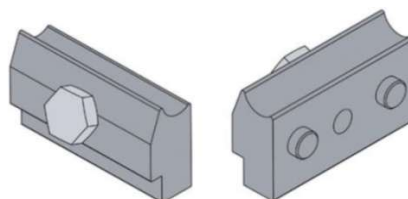

Kutterkil KIL360-048	
Kutterkil, Överkutter MP280, MP360	
1 par	KIL360-048



Kutterkil STÄLLKIL-038	
Kutterkil, Över, underkutter MP260, Underkutter MP280, MP360	
1 par	STÄLLKIL-038



Kutterkil STÄLLKIL360-048	
Kutterkil, Överkutter MP280, MP360	
1 par	STÄLLKIL360-048



Kutter	TB90-92 STÅL Z2	
Kutter	Sidokutter, D88 b40 d30 Z2	2 stål
1 st	TB90-92 Z2 Stål	



Kutter	TB90-92 STÅL Z4	
Kutter	Sidokutter, D88 b40 d30 Z4	4 stål
1 st	TB90-92 Z4 Stål	

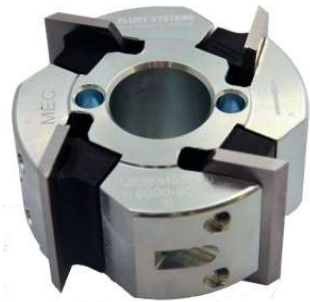

Priser på hyvelstål

HSS-510	833:-
HSS-RPH410	1023:-
HSS-PH300	932:-
9500-20HSS	819:-
KIL-038	477:-
STÄLLKIL-038	537:-
TIMKIL-038	512:-
KIL360-048	1029:-
STÄLLKIL360-048	1700:-
94000HSS	699:-
95000HSS	901:-
96000HSS	1098:-
98000HSS	1594:-
91000HSS	1594:-
91300HSS	2031:-
TB90-92 Z2 Stål Kutter	1828:-
TB90-92 Z4 Stål Kutter	2644:-

2026-04-01

Moms tillkommer på alla priser.



Wood-Mizer
from forest to final form

MEKWOOD AB

Magasinsgatan 29, 812 31 Storvik - 0290-515 65, 070-679 79 65

info@mekwood.se - www.mekwood.se - www.woodmizer.se