

# HYVELSTÅL och Tillbehör



**Wood-Mizer**<sup>®</sup>

*from forest to final form*

**MEKWOOD AB**

Magasinsgatan 29, 812 31 Storvik - 0290-515 65, 070-679 79 65  
info@mekwood.se - www.mekwood.se - www.woodmizer.se

# Kombinationer

## REGEL & TRALL

### ■ Rak

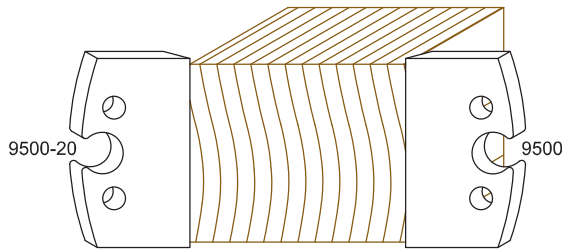

### ■ Avrundning, enkel

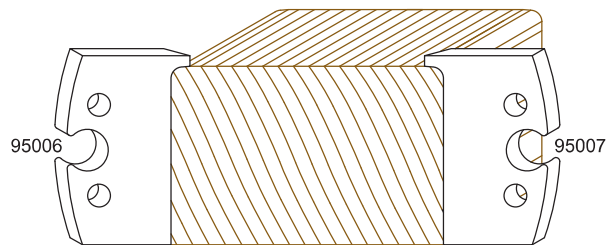

### ■ Avrundning, dubbel, 22 mm

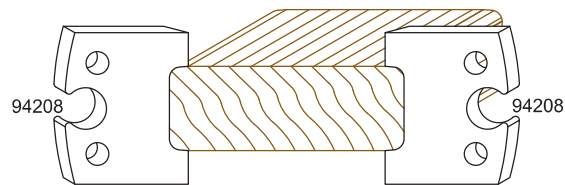

### ■ Avrundning, dubbel, 25 mm

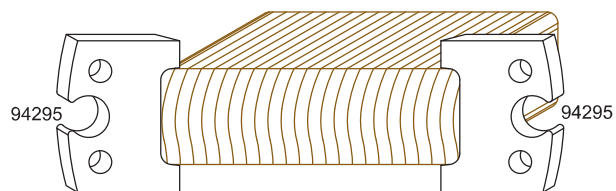

### ■ Avrundning, dubbel, 28 mm

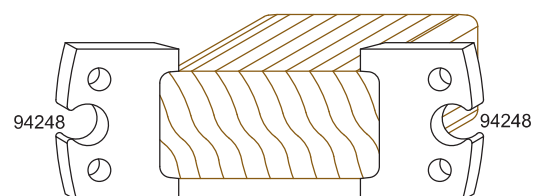

### ■ Avrundning, dubbel, 45 mm

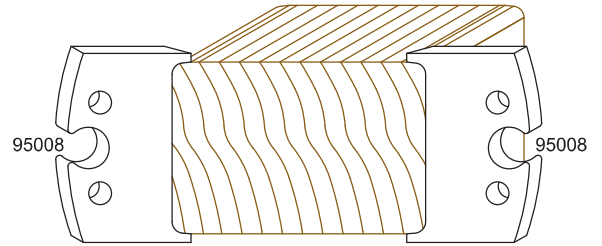

### ■ Avrundning, dubbel, 48 mm

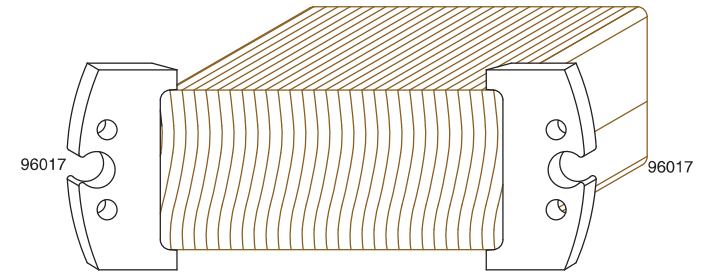

### ■ Grepp profil 1

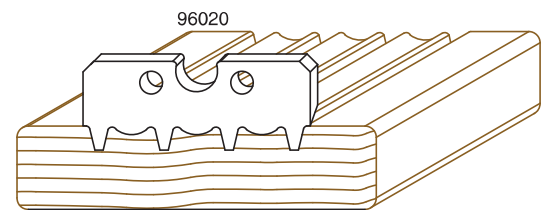

### ■ Grepp profil 2

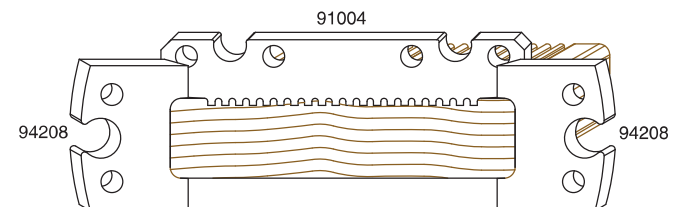

### ■ Grepp profil 3

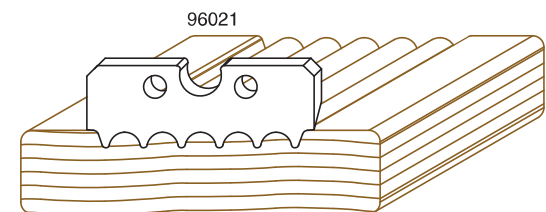

# NOT & SPONT

## ■ Not & Spont, 4 mm (tät 0,1 mm)

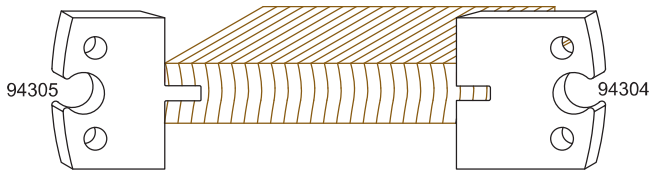

## ■ Not & Spont, 4,5 mm (tät 0,1 mm)

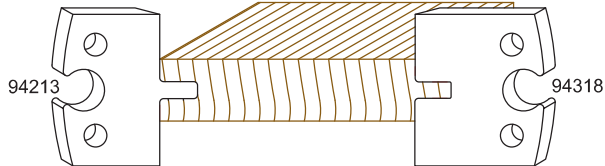

## ■ Not & Spont, 6 mm (tät 0,1 mm)

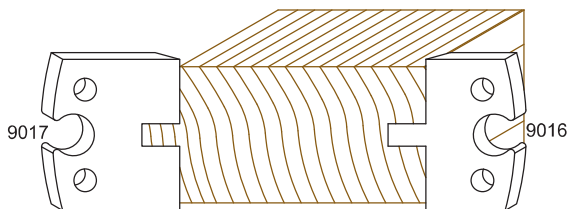

## ■ Not & Spont, 6 mm (Råspont)

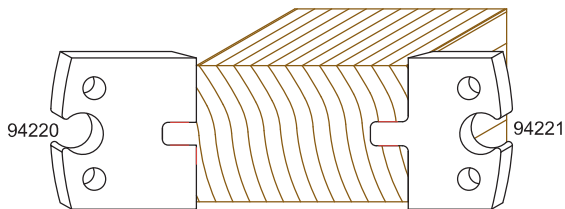

## ■ Not & Spont, 8 mm (Golvspont)

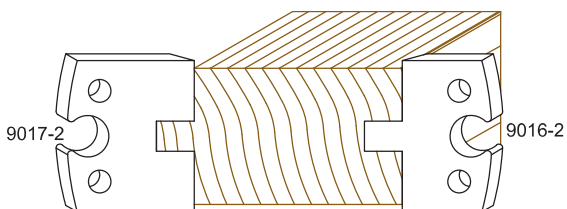

## ■ Not & Spont, 10 mm (Golvspont)

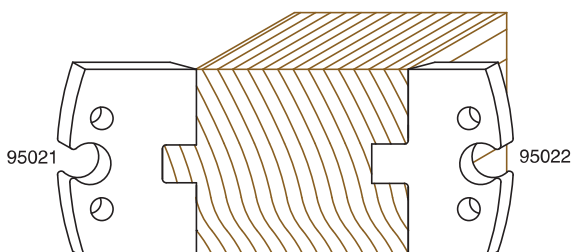

## ■ Not & Spont, 10 mm (tät)

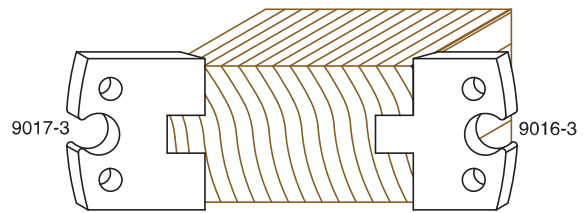

## ■ Not & Spont (Badkar)

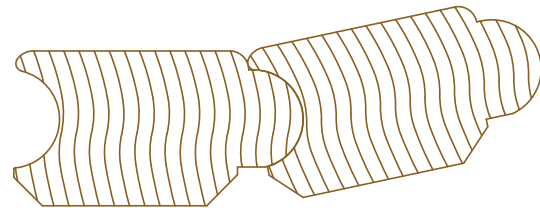
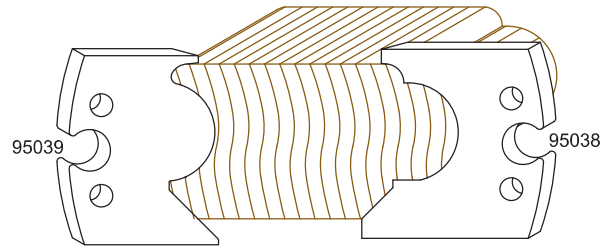

## ■ Not & Spont (Badkar)

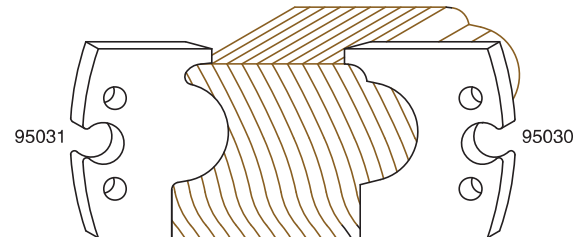

## ■ Not & Spont (Golvspont med spikfas)

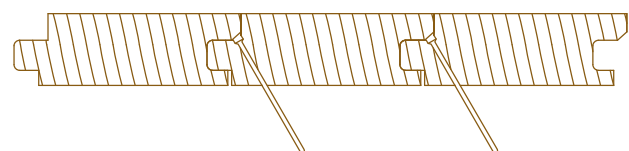
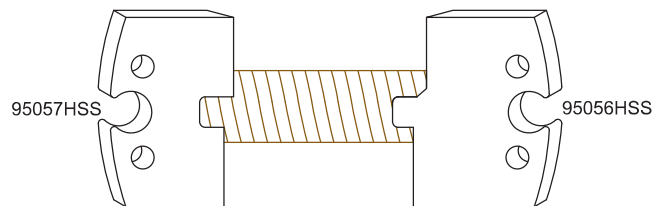

### ■ Not & Spont (Golvspont med spikfas)

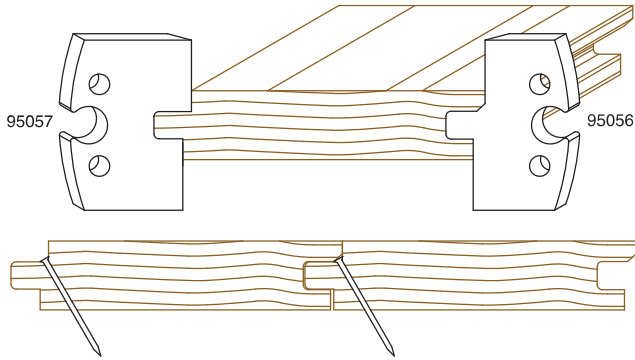

### ■ Not & Spont (Golvspont)

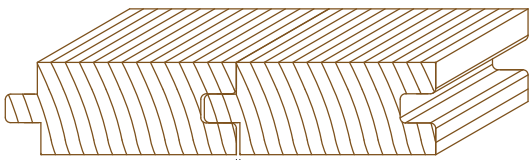
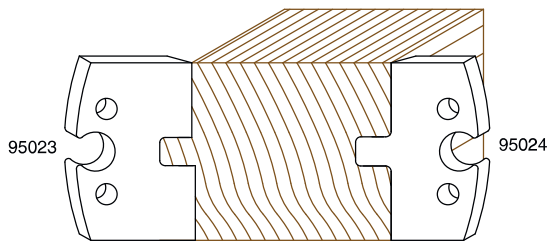

### ■ Not & Spont (Fasad golvprofil med spikfas)

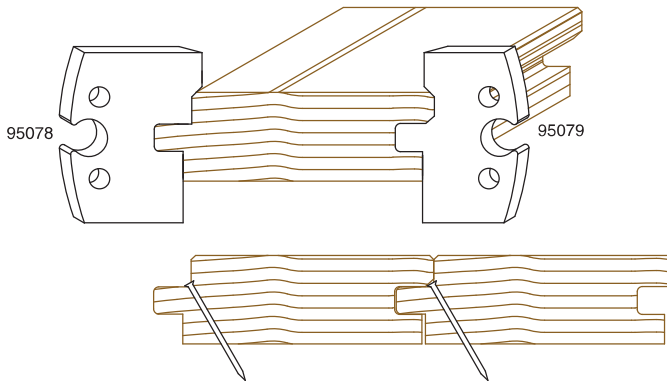

### ■ Not & Spont (Kantotstål)

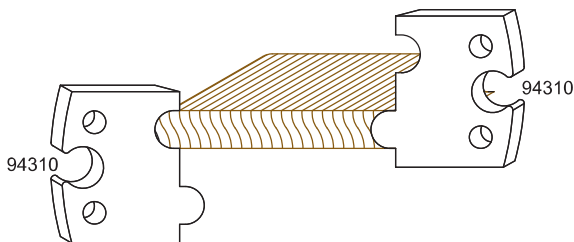

### ■ Not & Spont (Friggebod)

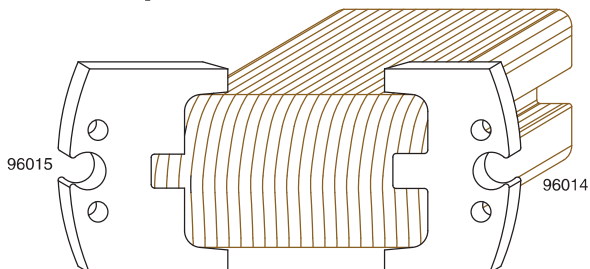

### ■ Not & Spont (Friggebod usa)

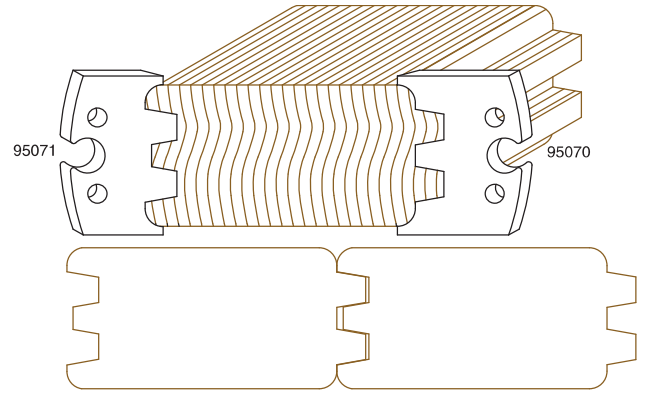

## UTOMHUSPANELER

### ■ Faspanel

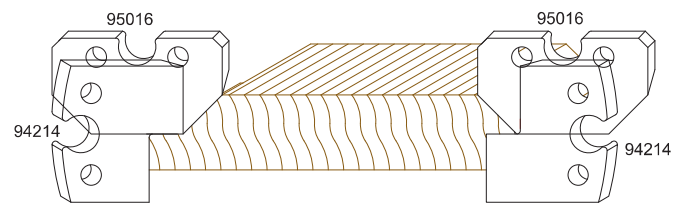

### ■ Faspanel, not 3 mm

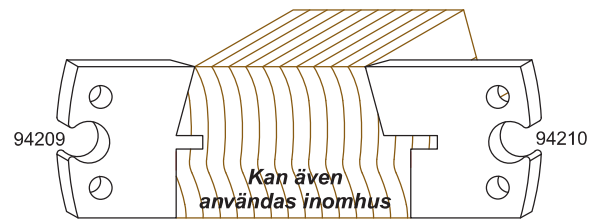

### ■ Faspanel, not 5 mm

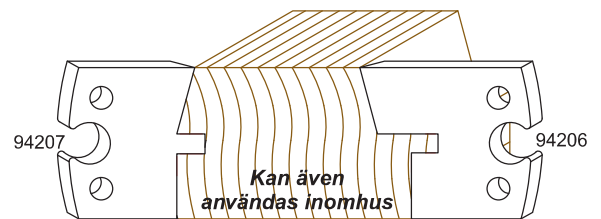

### ■ Avrundad panel

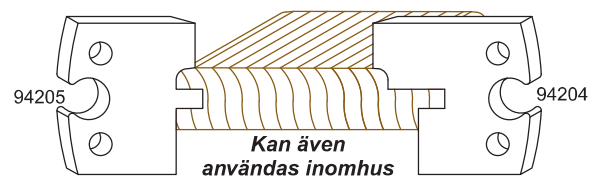

### ■ Hålkälspanel

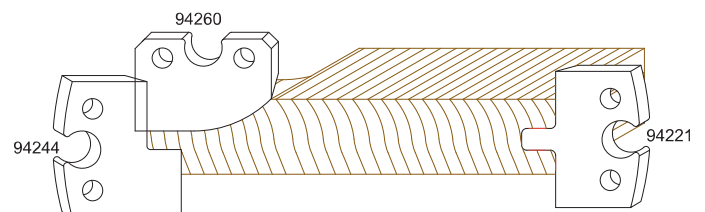

### ■ Stockpanel

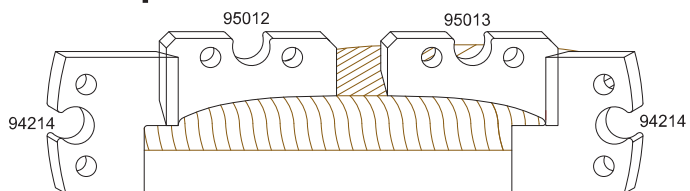

### ■ Norgepanel, svanhals

Stående not- och spontpanel med sågad framsida. 4-skärig kutter behövs.

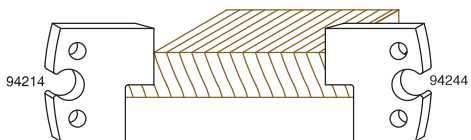
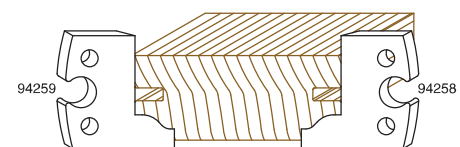
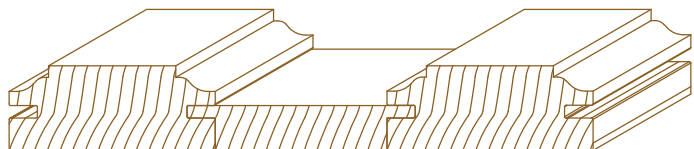

### ■ Norgepanel, hälkäl

Stående not- och spontpanel med sågad framsida. 4-skärig kutter behövs.

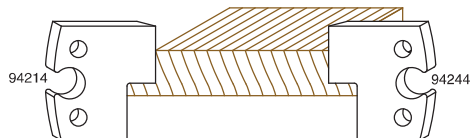
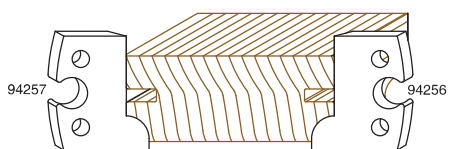
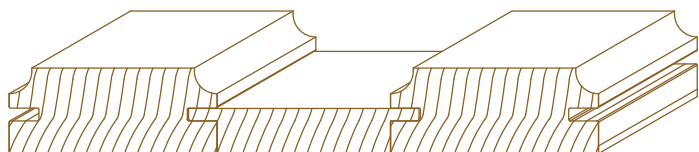

### ■ Stockhuspanel, 45 mm

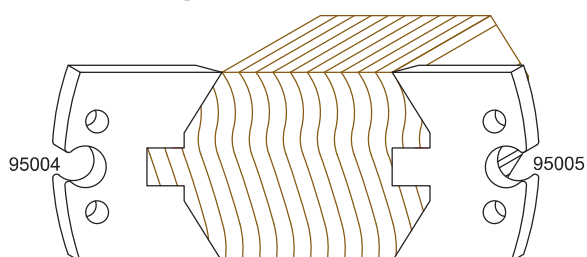

### ■ Stockhuspanel, 70 mm

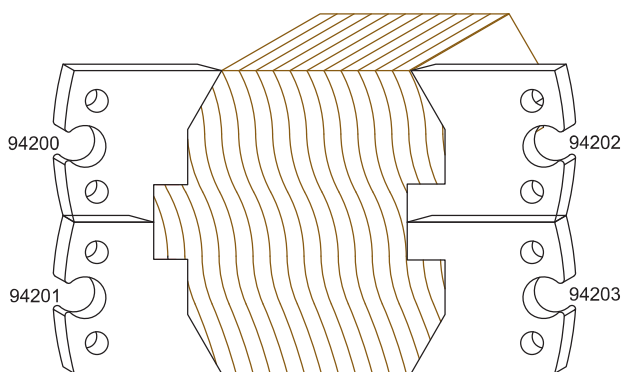

### ■ Fjällpanel

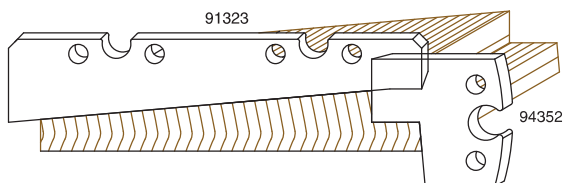

## INOMHUSPANELER

### ■ Morapanel

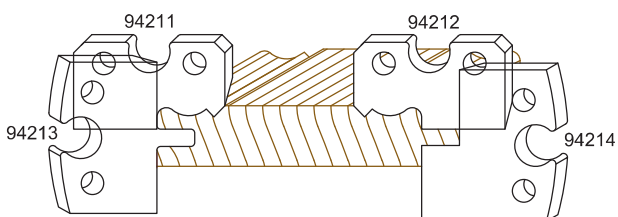

### ■ Pärlspont

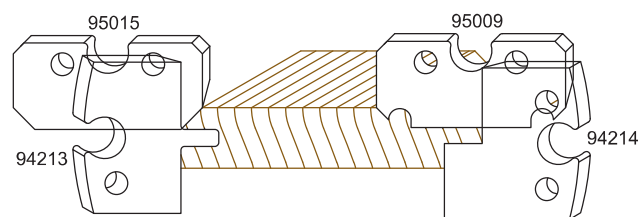

### ■ Pärlspont med mittprofil

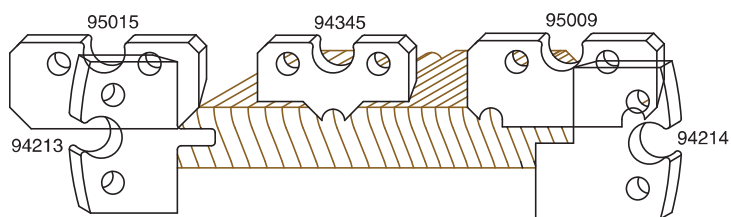

## ■ Stor pärlspont

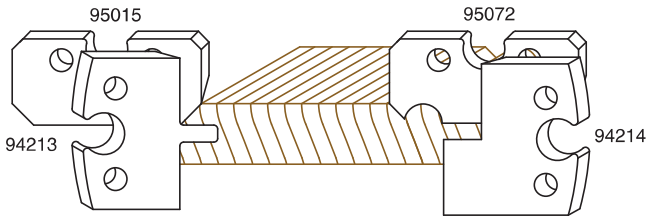

## ■ Avrundad panel

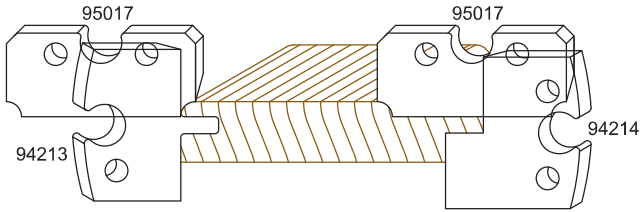

## ■ Faspanel

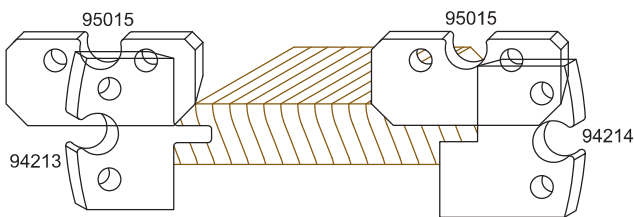

## ■ 45° Faspanel

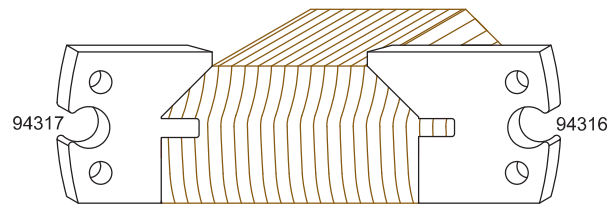

## ■ Dubbel 45° Faspanel

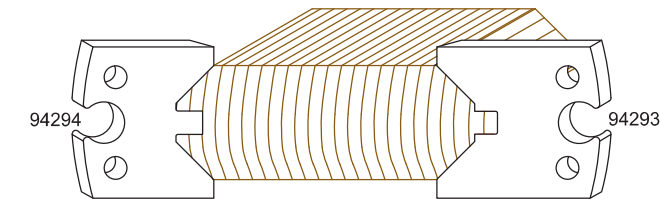

## ■ Faspanel med mittprofil

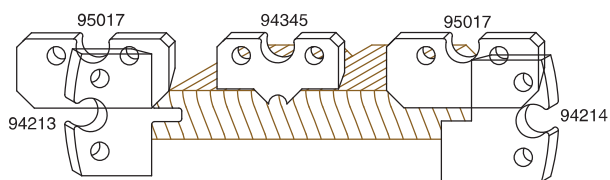

## ■ Faspanel med mittprofil

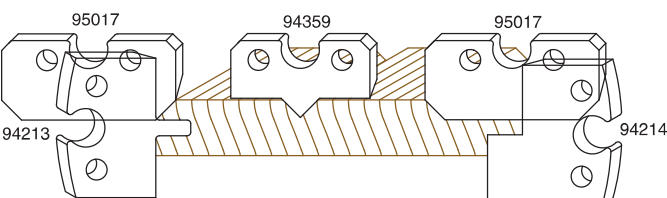

## ■ Faspanel

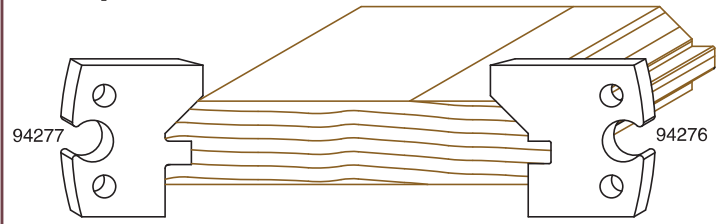

## ■ Enkel takpanel

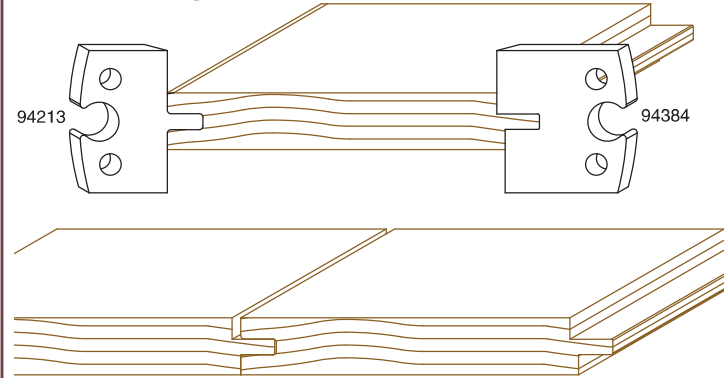

# LOCKPANEL

## ■ Hattlock

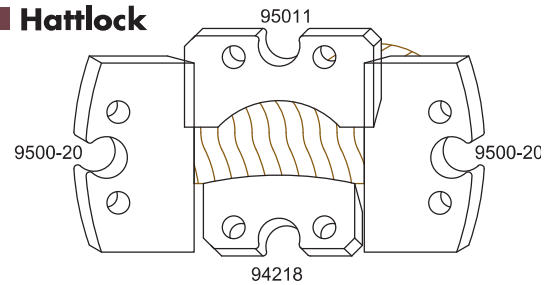

## ■ Faslock

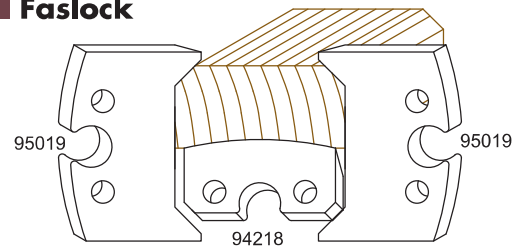

## ■ Dekorlock

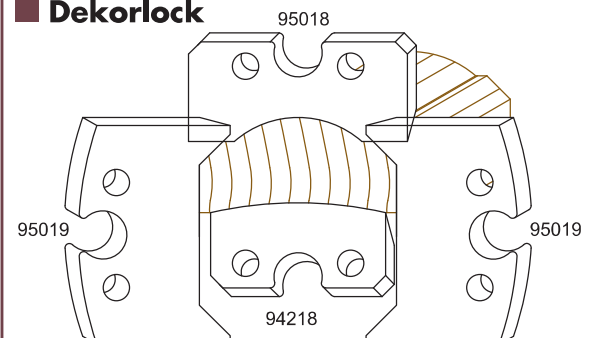

## ■ Dekorlock

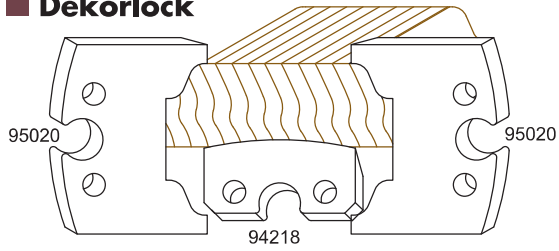

## ■ Dekorlock

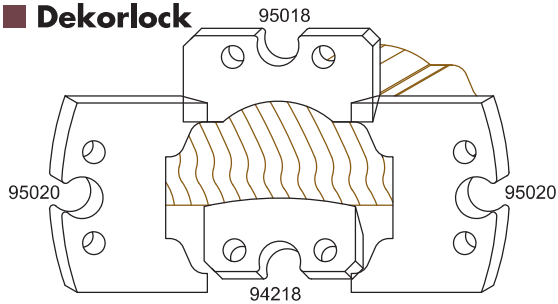

## BRÖSTLIST

### ■ Rundad

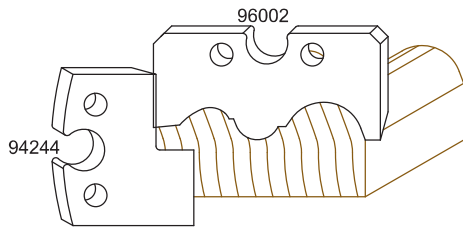

### ■ Profil

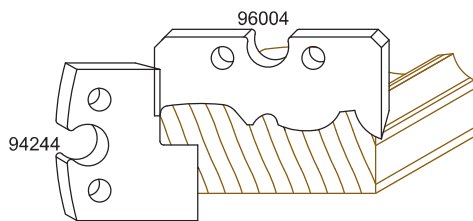

### ■ Profil

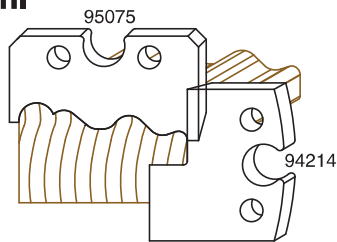

### ■ Villa Frimodig

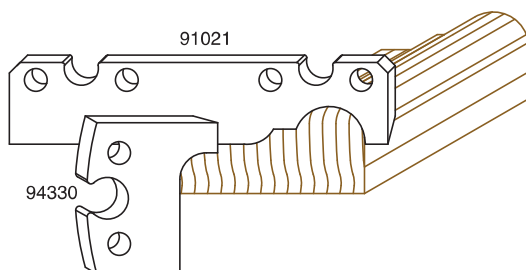

## SPÄRNING & URFRÄSNING

### ■ Spärning av foder

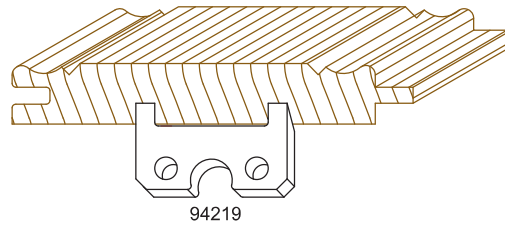

### ■ Urfräsning av foder

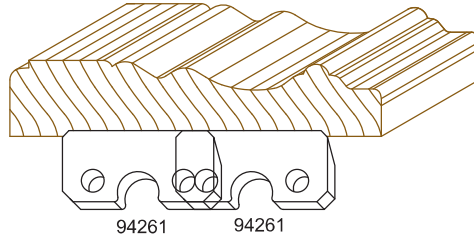

### ■ Urfräsning av golvlist

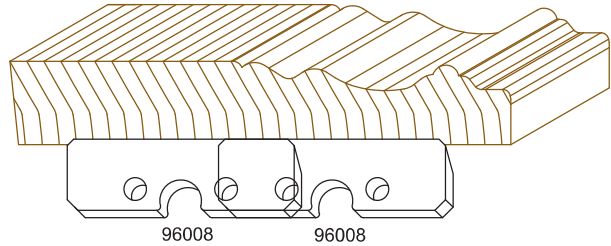

## GOLVLIST

### ■ Smyglist

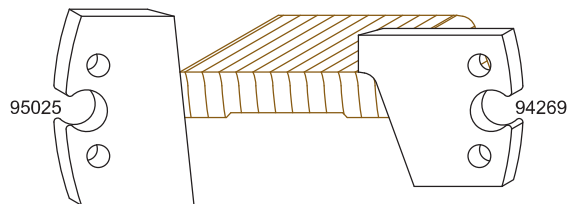

### ■ Stocklist

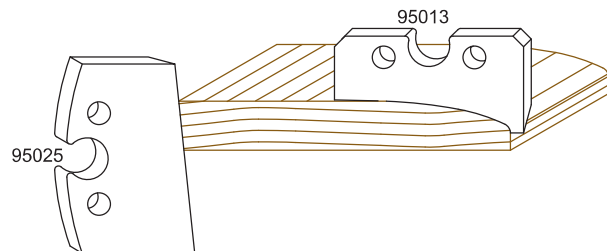

### ■ Svanhalslist

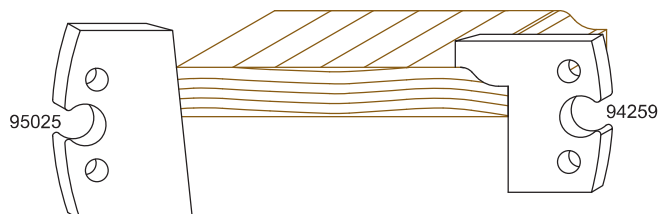

### ■ Kvartstavslist

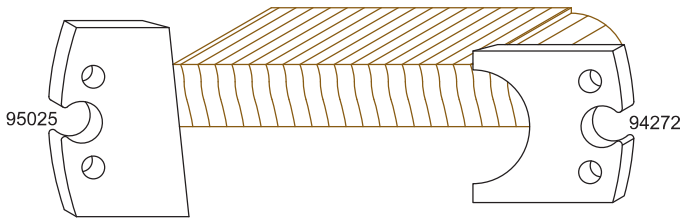

### ■ Allmogelist

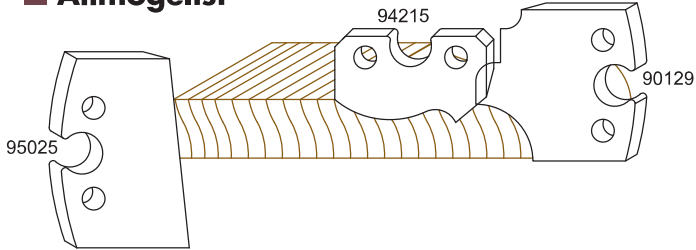

### ■ Hagalist

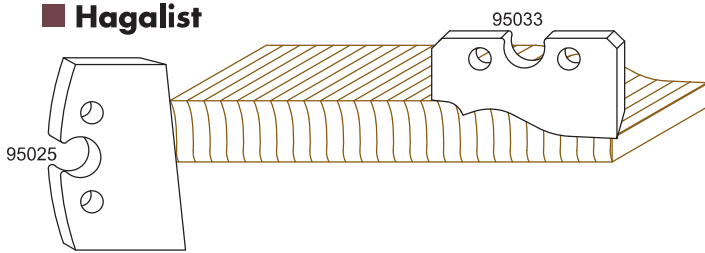

### ■ Gamlestadsl

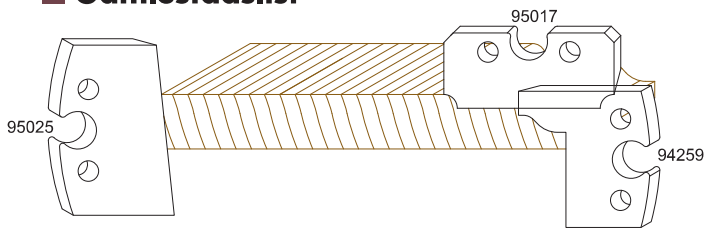

### ■ Stockholmslist

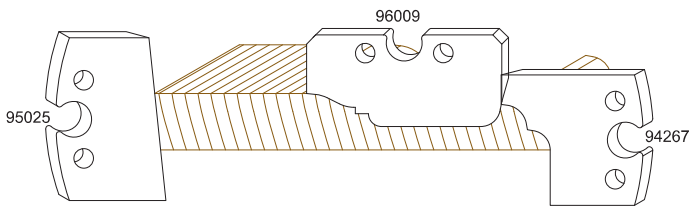

### ■ Gotlandslist

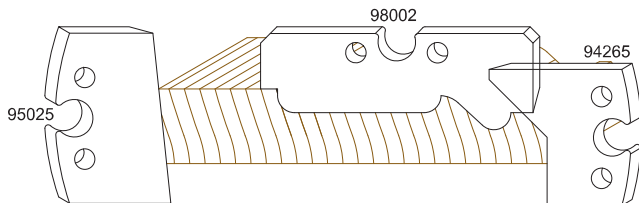

### ■ Hallandslist

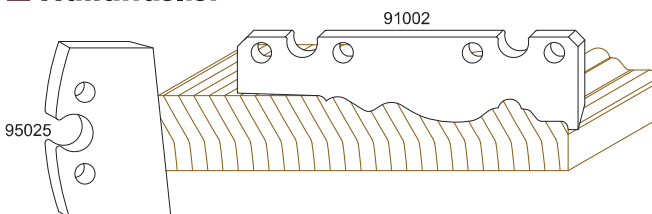

### ■ Backalist

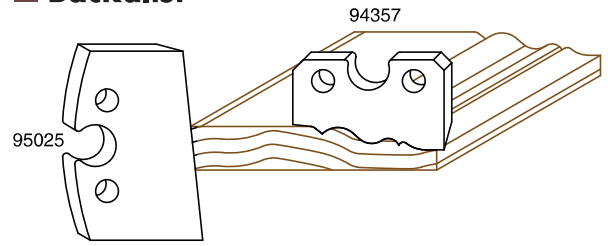

### ■ Utbylist

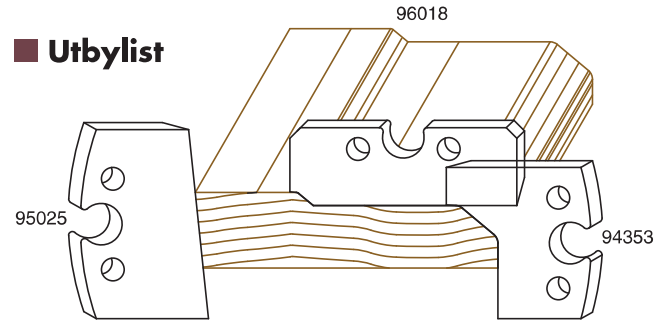

### ■ Villa Frimodig

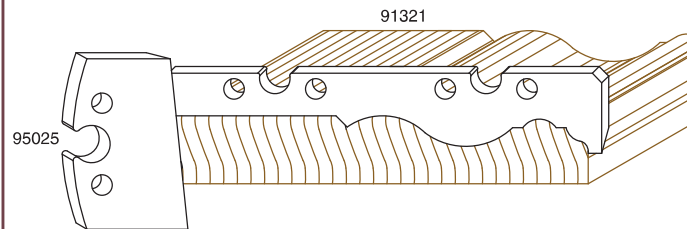

## DÖRRPROFIL

### ■ Dörrprofil 1

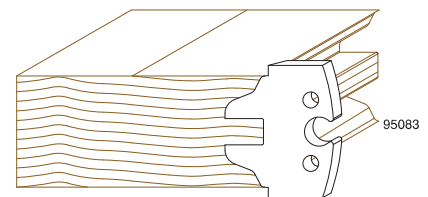
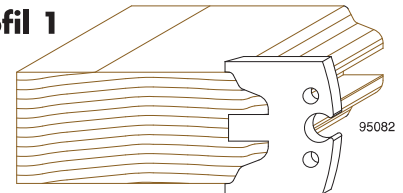

### ■ Dörrprofil 2

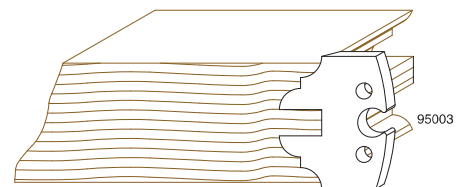
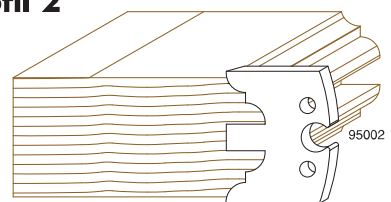



# HÖRNBLOSS

## Förbindning

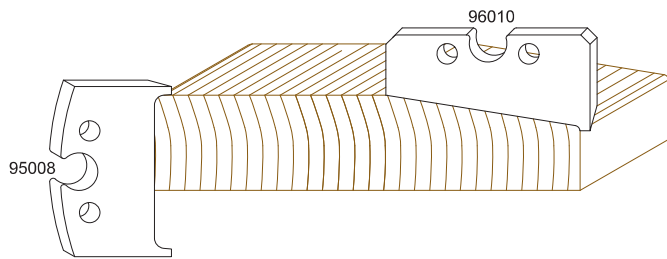

En dekorativ förbindningskloss för att få snygga avslutningar på olika lister. Mycket bra vid kraftiga profiler på listerna.

## Dekorfoder, 95 mm

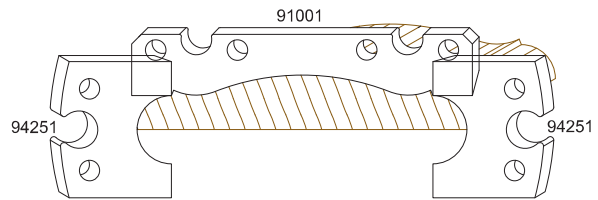

## Gamlestads

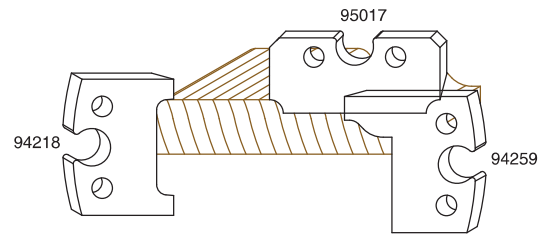

## Gotland

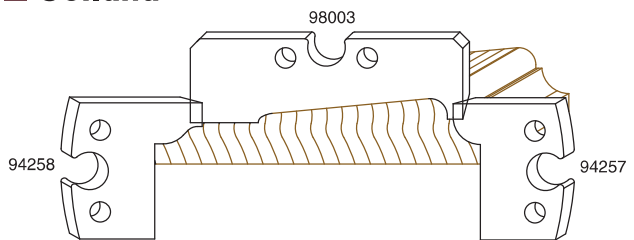

## Hagafoder

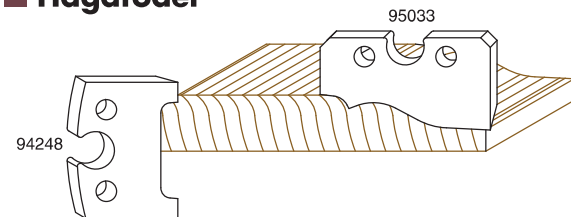

## Halland

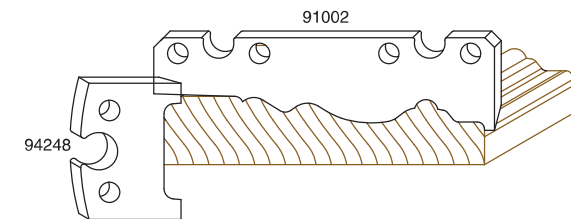

## Kvartstav

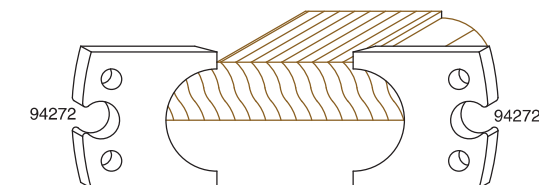

## Doortrim

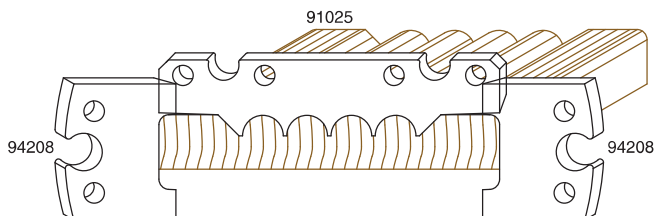

# FODER

## Allmogefoder

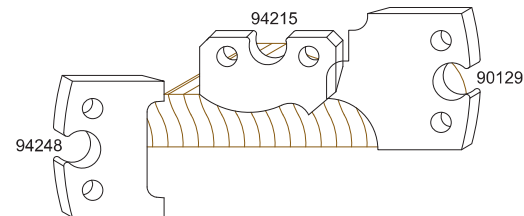

## Amerikafoder, 57mm

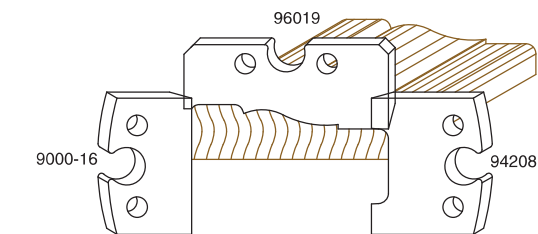

## Backafoder

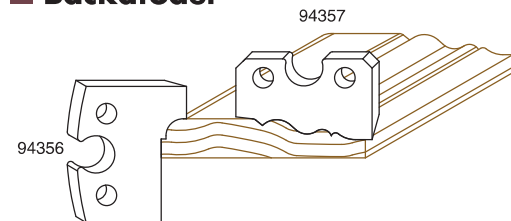

## Dekorfoder, 70 mm

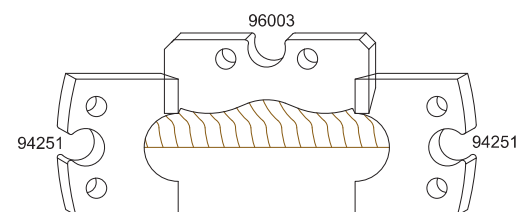

## Rundat foder

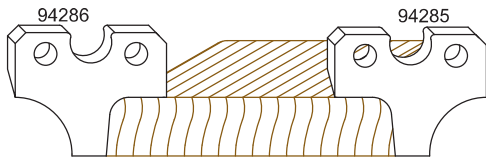

## Skiröfoder

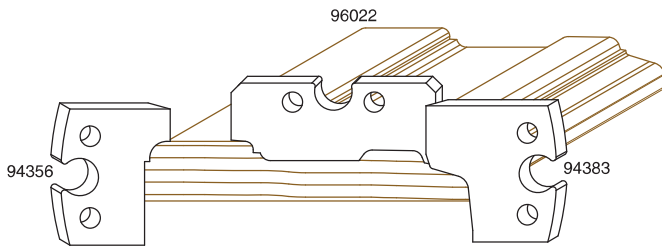

## Stockholm

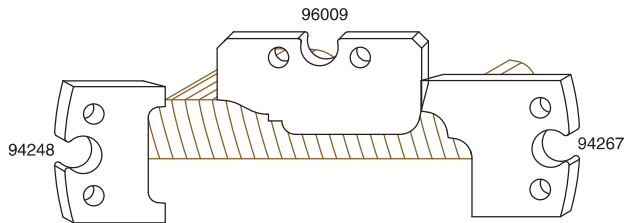

## Svanhals

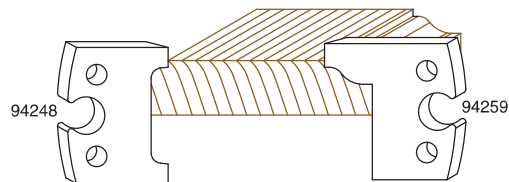

## Sätrafoder

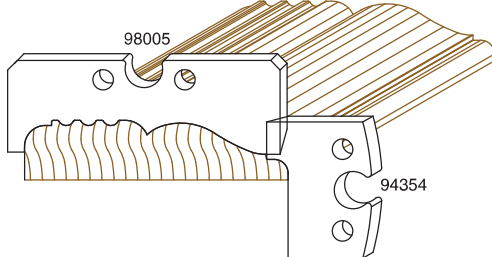

## Utbyfoder

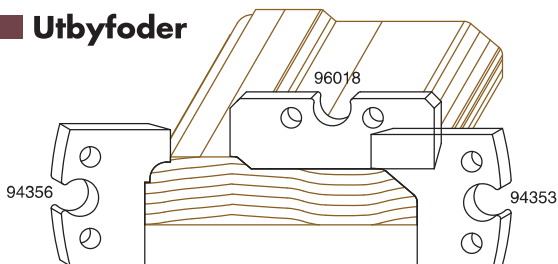

## Villa Frimodig

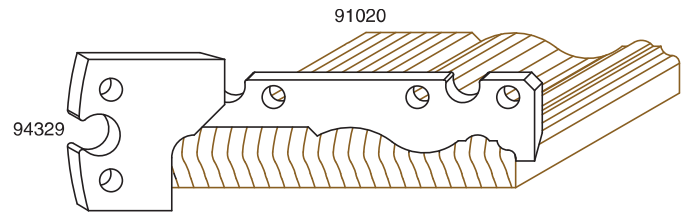

# TAKLIST

## Skugglist

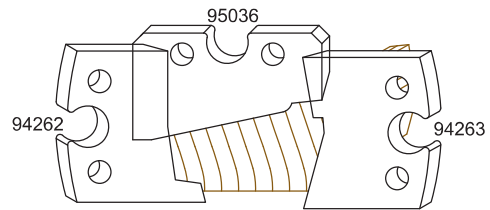

## Trappstegslist

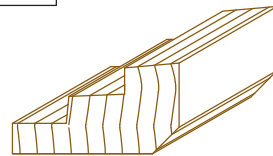
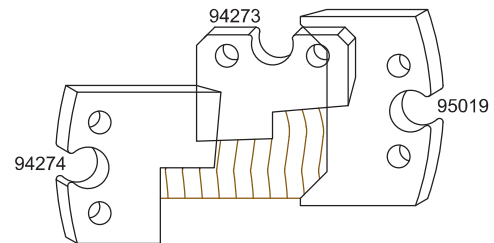

## Kvartstavstaklist

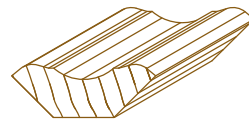
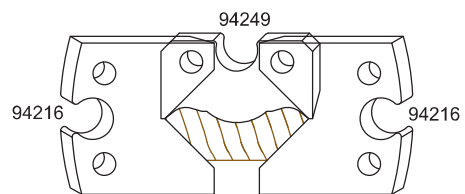

## Profiltaklist, 70 mm

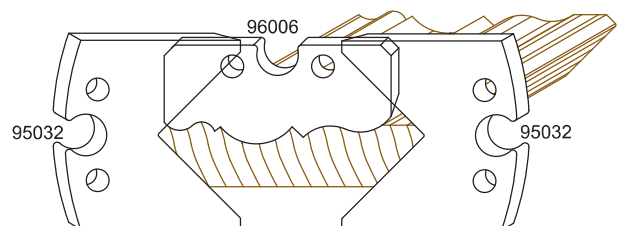

### ■ Svanhalstaklist, 45 mm

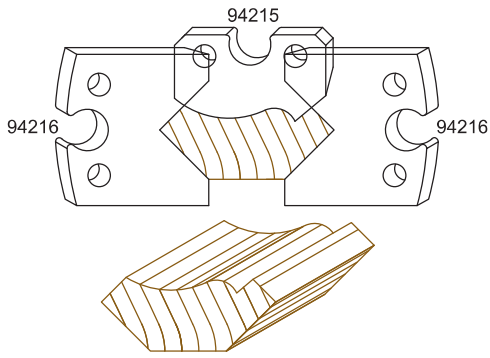

### ■ Svanhalstaklist, 56 mm

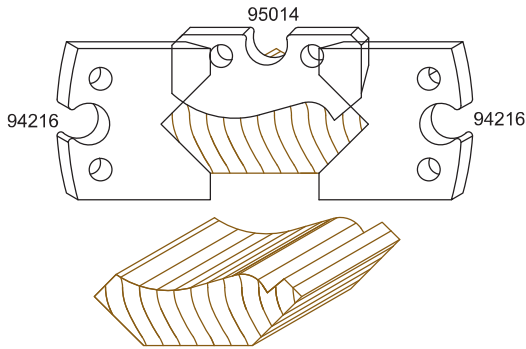

### ■ Svanhalstaklist, 68 mm

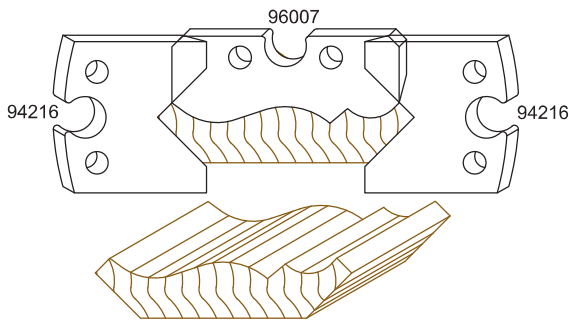

### ■ Svanhalstaklist, 80 mm

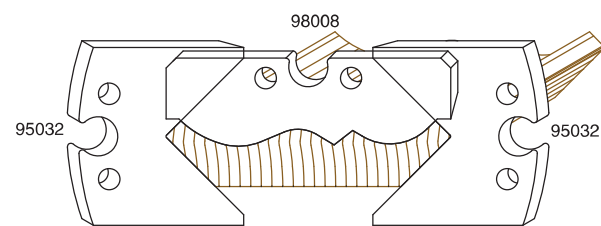

### ■ Svanhalstaklist, 95 mm

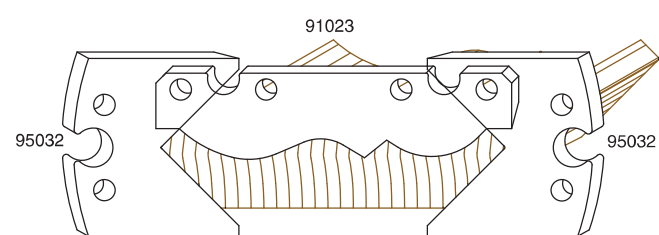

### ■ Svanhalstaklist, 120 mm

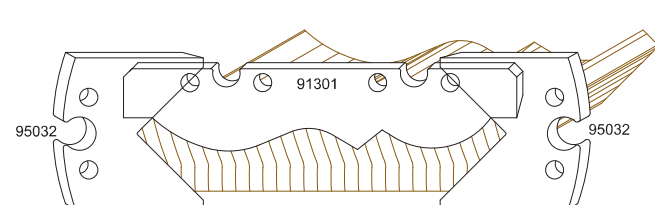

### ■ Svanhalstaklist usa, 80 mm

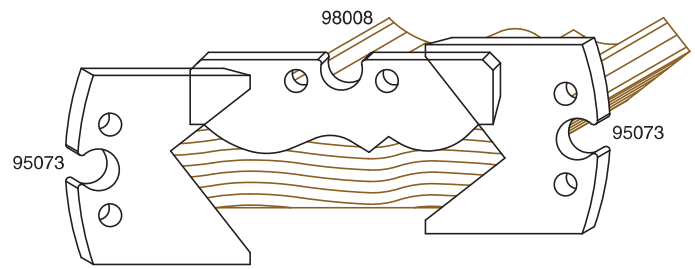

### ■ Hålkälstaklist, 45 mm

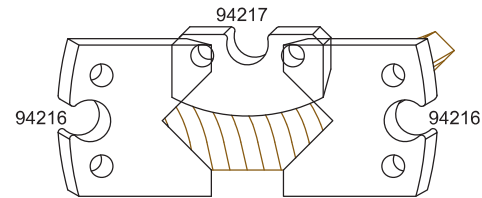

### ■ Hålkälstaklist, 60 mm

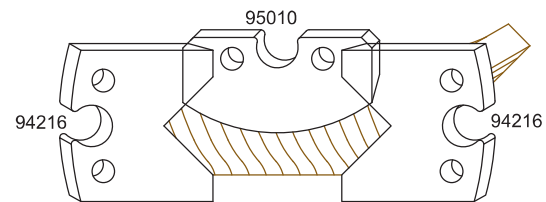

### ■ Hålkälstaklist, 70 mm

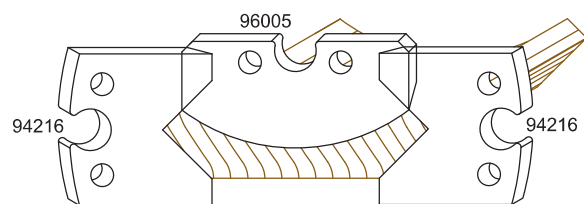

### ■ Hålkälstaklist, 95 mm

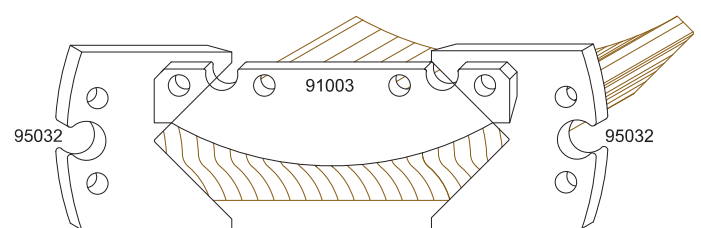

### ■ Stukaturlist

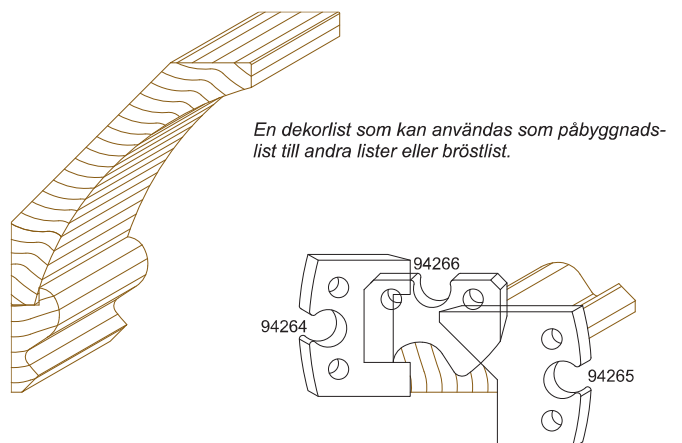

**Backataklist**

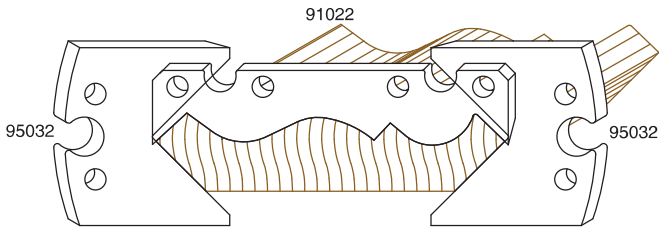

**Utbylist**

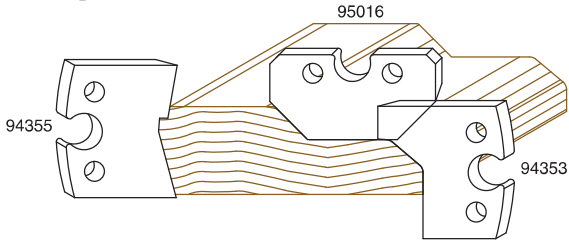

**Villa Frimodig**

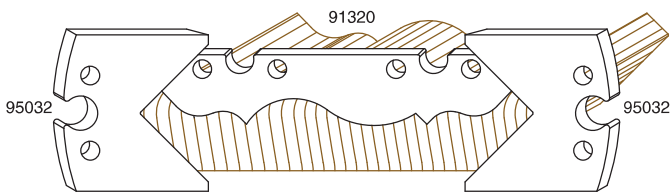

**KVARTSSTAV**

**Kvartsstav, 15 mm**

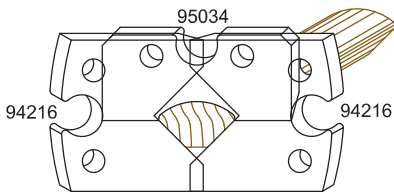

**Kvartsstav, 21 mm**

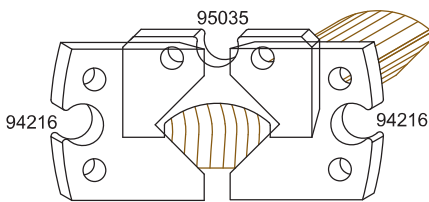

**GARDINSTÅNG**

**Diameter 30 mm**

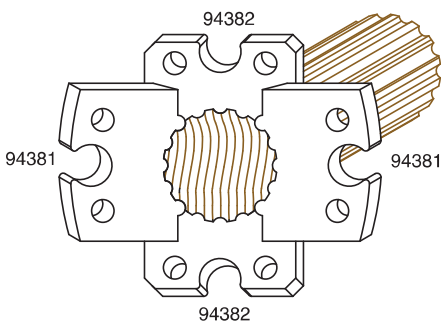

**RUNDSTAV**

**Rundstav, 21 mm**

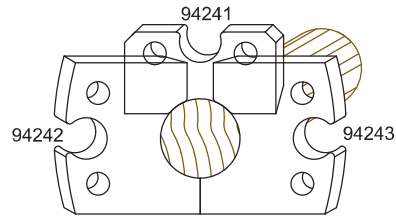

**Rundstav, 24 mm**

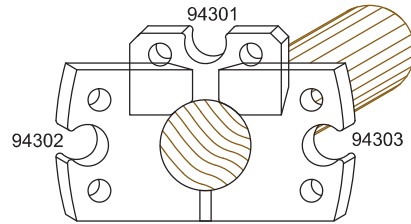

**Rundstav, 27 mm**

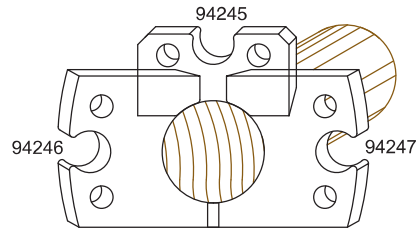

**Rundstav, 40 mm**

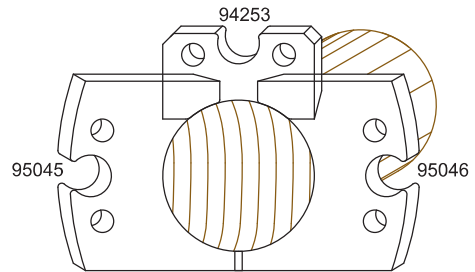

**FASSTÅL**

**Dubbel 45° fasning**

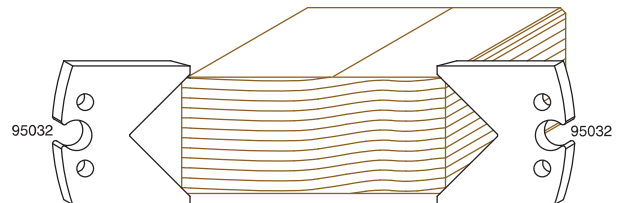

**Enkel 45° fasning**

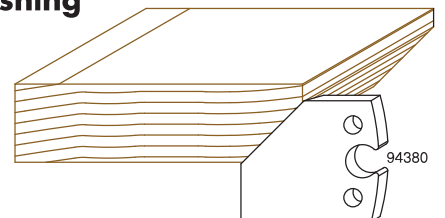

## UNDERBRÄDA TILL FÖNSTER

### ■ Profil

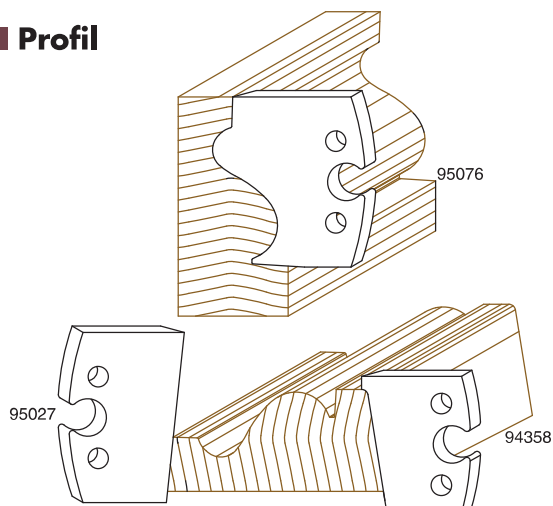

### ■ Villa Frimodig

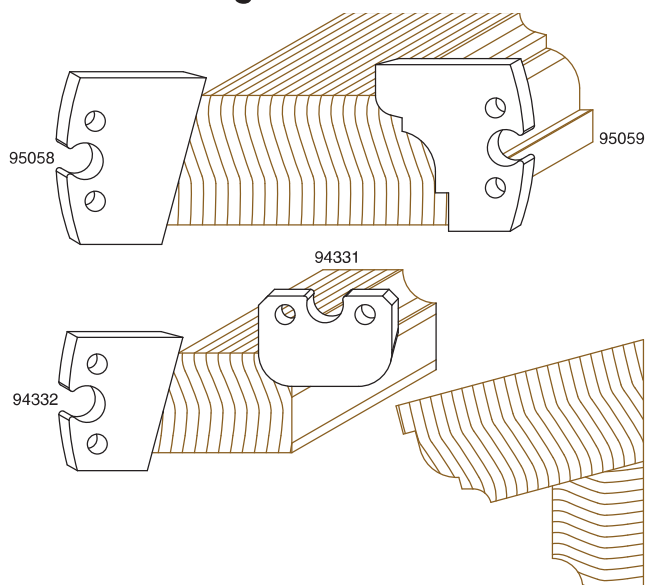

## FALSSTÅL

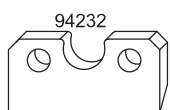

**94232HSS**  
Detta stål ger 2 mm falsdjup

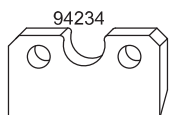

**94234HSS**  
Detta stål ger 4 mm falsdjup

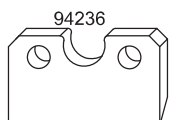

**94236HSS**  
Detta stål ger 6 mm falsdjup

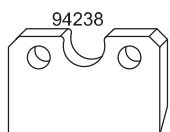

**94238HSS**  
Detta stål ger 8 mm falsdjup

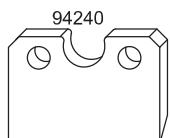

**94240HSS**  
Detta stål ger 10 mm falsdjup

## STÅL TILL SOLOHYVELN

I Solohyveln kan i vissa fall mer än 10 mm utstick användas i överkuttern, vilket gör att dessa stål enbart passar till denna maskinen. Ett sådant stål är 95028HSS.

### ■ Rundat foder

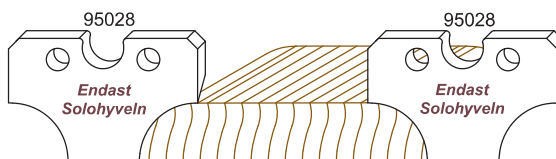

### ■ Rundad golvlist

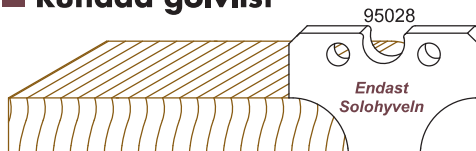

### ■ Allmogefoder

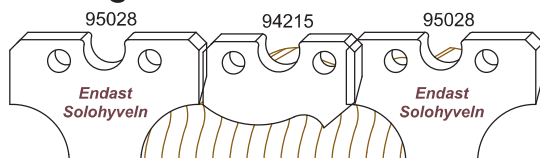

### ■ Allmogegolvlist

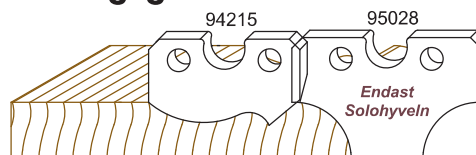

### ■ Faspanel

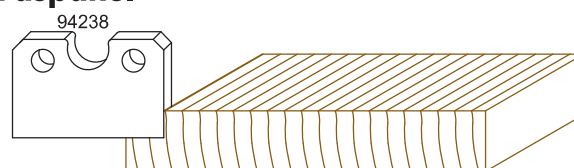

Starta med att hyvla en fals på baksidan.

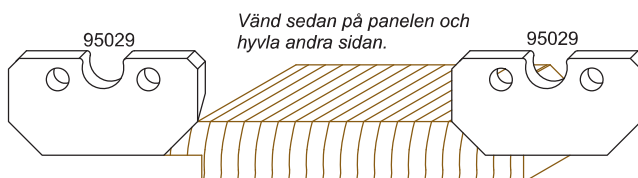

### ■ Stål för trallvirke

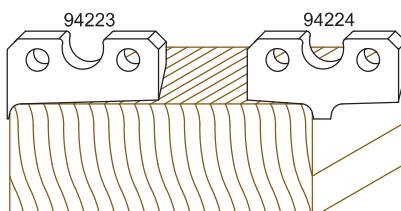

# Profilstål i HSS 40 x 4 mm

## 40 mm

■ 94200HSS

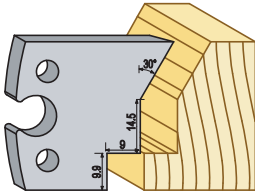

■ 94201HSS

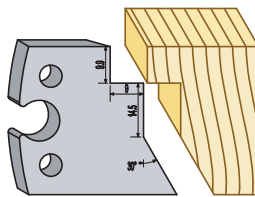

■ 94202HSS

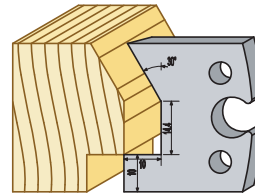

■ 94203HSS

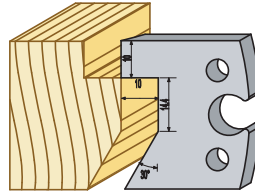

■ 94204HSS

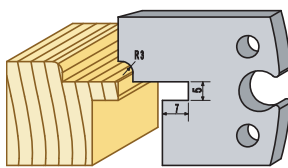

■ 94205HSS

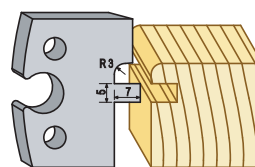

■ 94206HSS

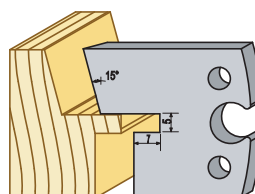

■ 94207HSS

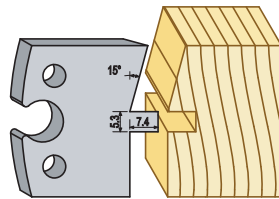

■ 94208HSS

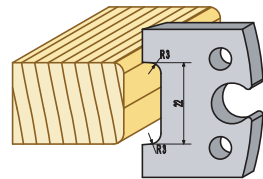

■ 94209HSS

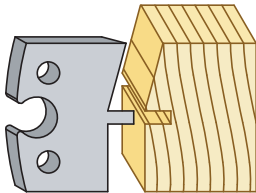

■ 94210HSS

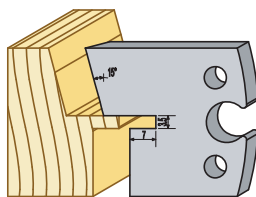

■ 94211HSS

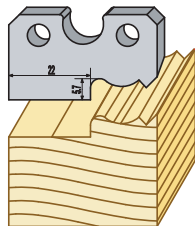

■ 94212HSS

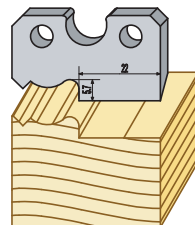

■ 94213HSS

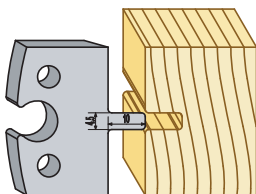

■ 94214HSS

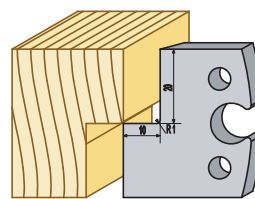

■ 94215HSS

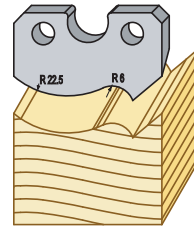

■ 94216HSS

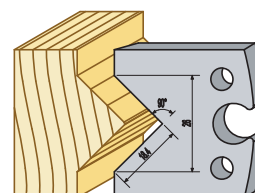

■ 94217HSS

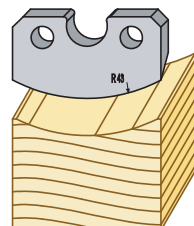

■ 94218HSS

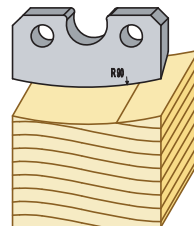

■ 94219HSS

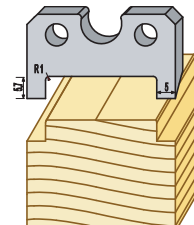

■ 94220HSS

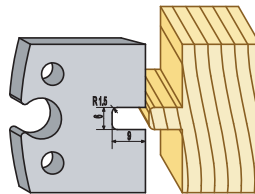

■ 94221HSS

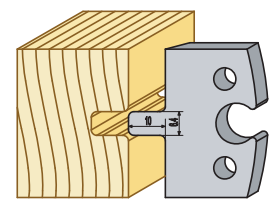

■ 94222HSS

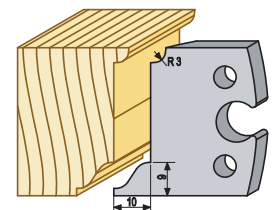

■ 94223HSS

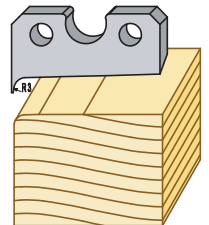

■ 94224HSS

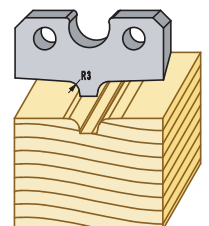

■ 94225HSS

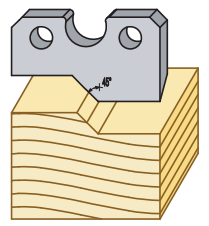

■ 94226HSS

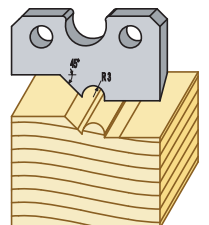

■ 94227HSS

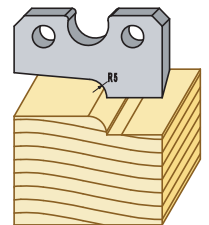

■ 94229HSS

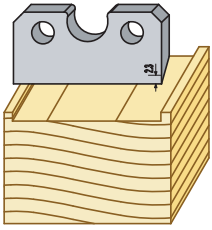

■ 94232HSS

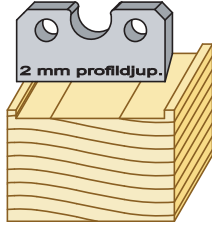

■ 94234HSS

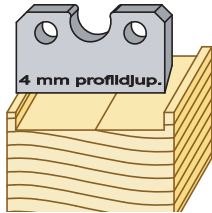

■ 94236HSS

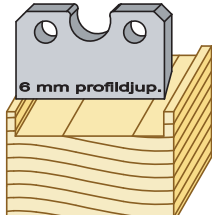

■ 94238HSS

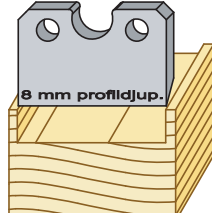

■ 94240HSS

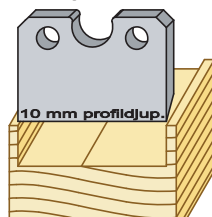

■ 94241HSS

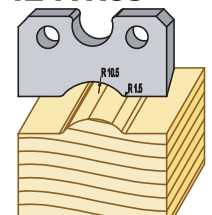

■ 94242HSS

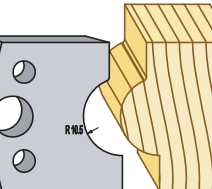

■ 94243HSS

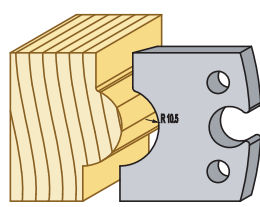

■ 94244HSS

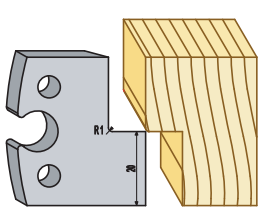

■ 94245HSS

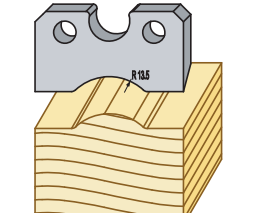

■ 94246HSS

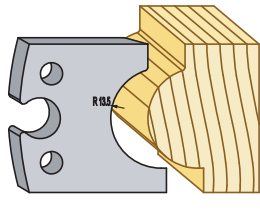

■ 94247HSS

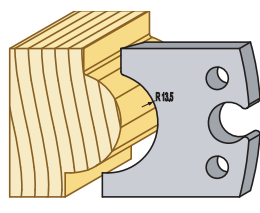

■ 94248HSS

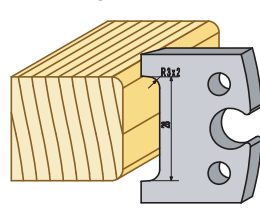

■ 94249HSS

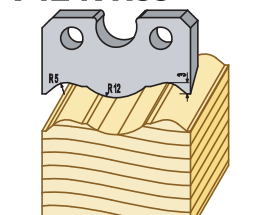

■ 94250HSS

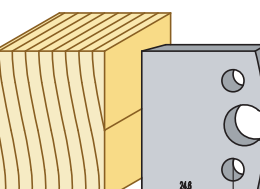

■ 94251HSS

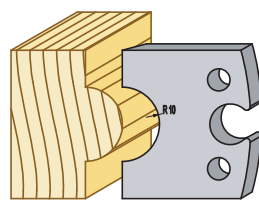

■ 94253HSS

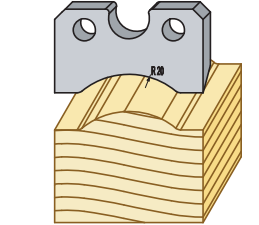

■ 94254HSS

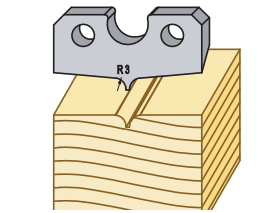

■ 94255HSS

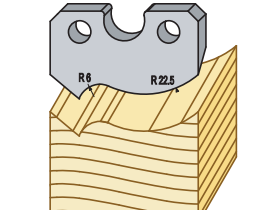

■ 94256HSS

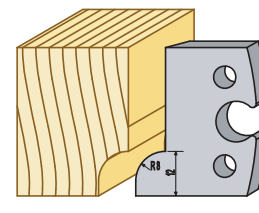

■ 94257HSS

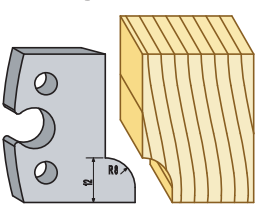

■ 94258HSS

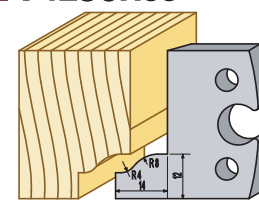

■ 94259HSS

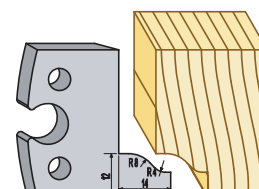

■ 94260HSS

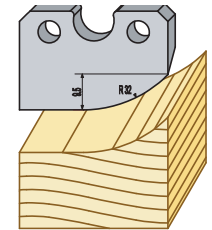

■ 94261HSS

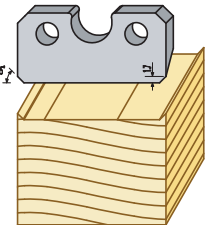

■ 94262HSS

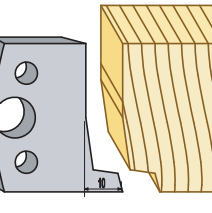

■ 94263HSS

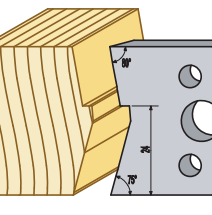

■ 94264HSS

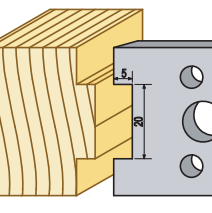

■ 94265HSS

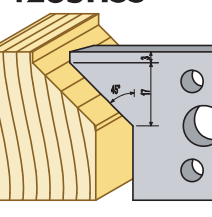

■ 94266HSS

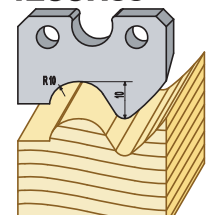

■ 94267HSS

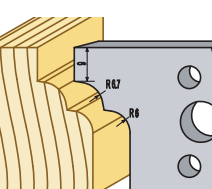

■ 94268HSS

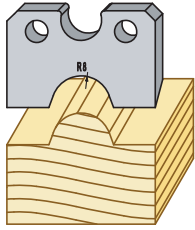

■ 94269HSS

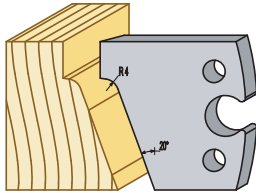

■ 94270HSS

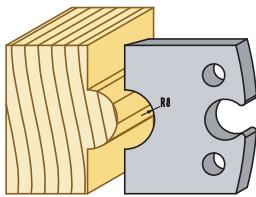

■ 94271HSS

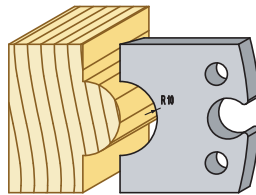

■ 94272HSS

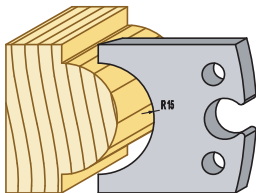

■ 94273HSS

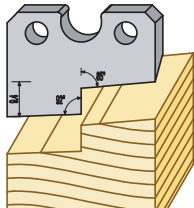

■ 94274HSS

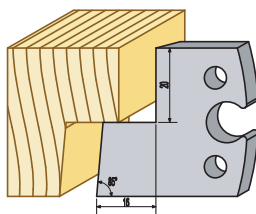

■ 94275HSS

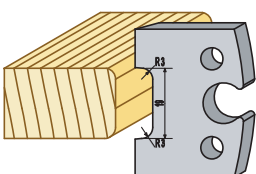

■ 94276HSS

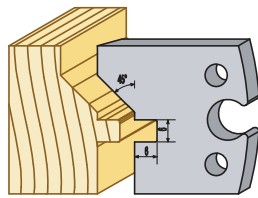

■ 94277HSS

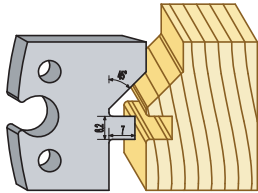

■ 94278HSS

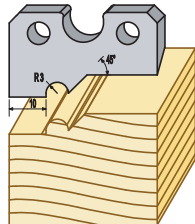

■ 94279HSS

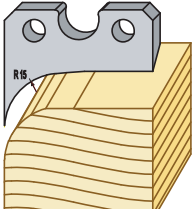

■ 94280HSS

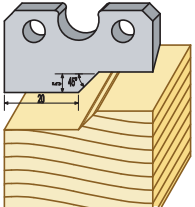

■ 94281HSS

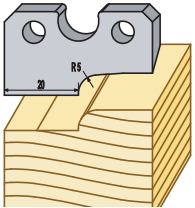

■ 94282HSS

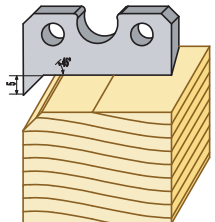

■ 94283HSS

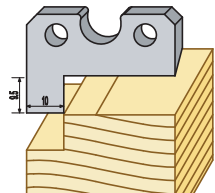

■ 94284HSS

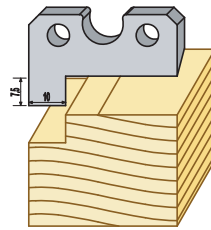

■ 94285HSS

Endast Solohyveln

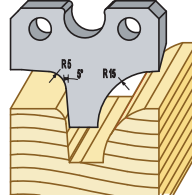

■ 94286HSS

Endast Solohyveln

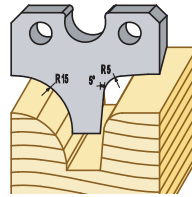

■ 94287HSS

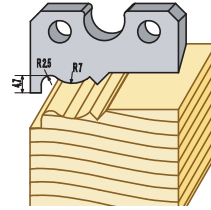

■ 94289HSS

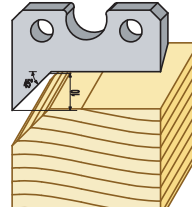

■ 94290HSS

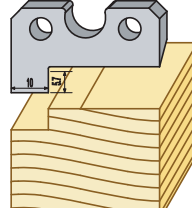

■ 94291HSS

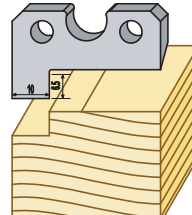

■ 94292HSS

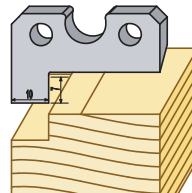

■ 94293HSS

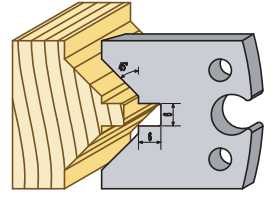

■ 94294HSS

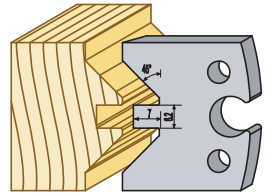

■ 94295HSS

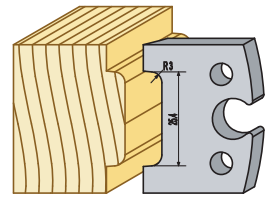

■ 94296HSS

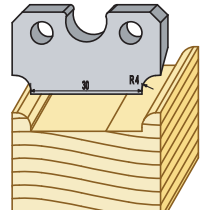

■ 94297HSS

Endast Solohyveln

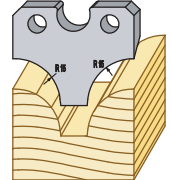

■ 94298HSS

Endast Solohyveln

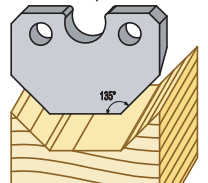

■ 94299HSS

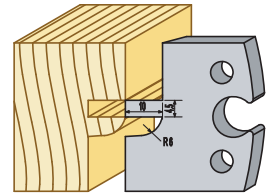

■ 94300HSS

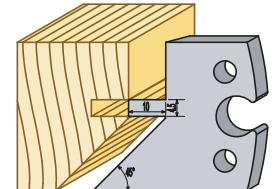



■ 94301HSS

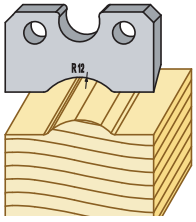

■ 94302HSS

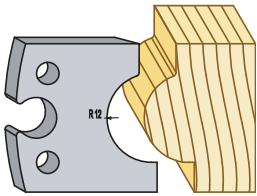

■ 94303HSS

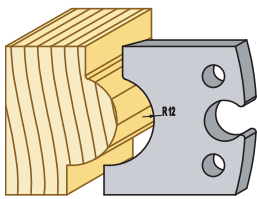

■ 94304HSS

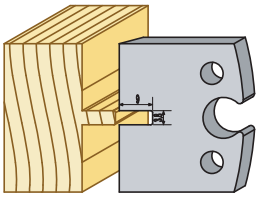

■ 94305HSS

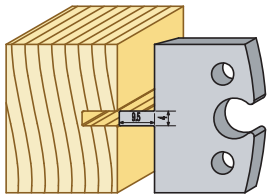

■ 94306HSS

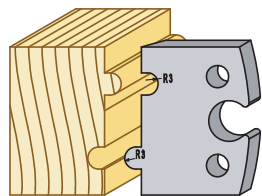

■ 94308HSS

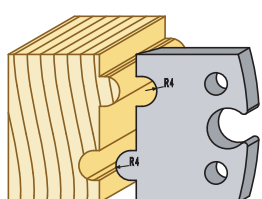

■ 94310HSS

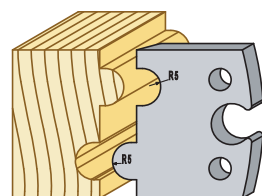

■ 94312HSS

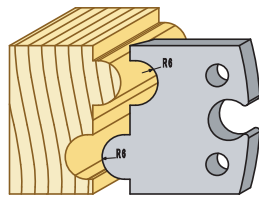

■ 94314HSS

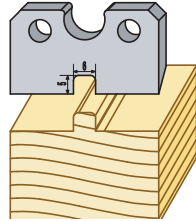

■ 94315HSS

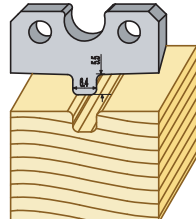

■ 94316HSS

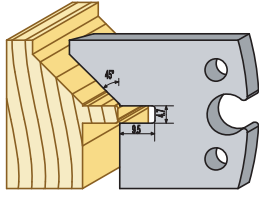

■ 94317HSS

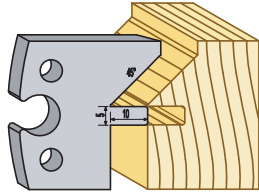

■ 94318HSS

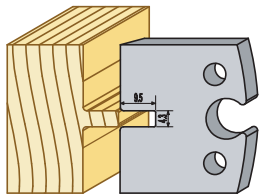

■ 94320HSS

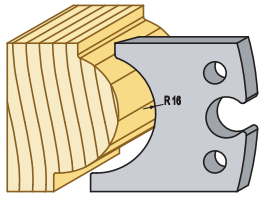

■ 94321HSS

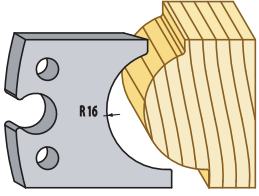

■ 94322HSS

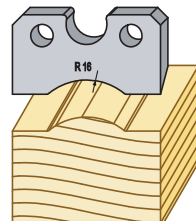

■ 94323HSS

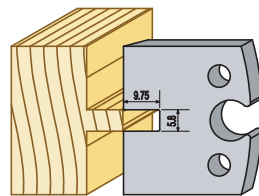

■ 94324HSS

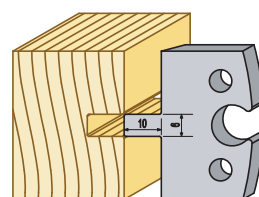

■ 94325HSS

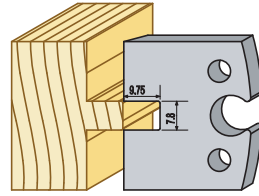

■ 94326HSS

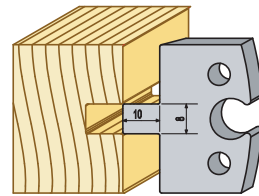

■ 94327HSS

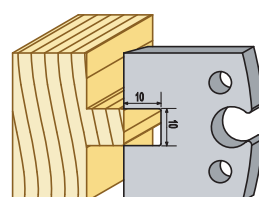

■ 94328HSS

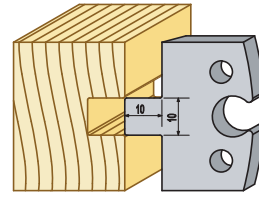

■ 94329HSS

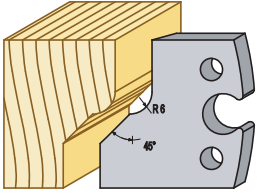

■ 94331HSS

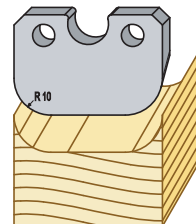

■ 94332HSS

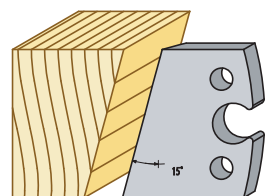

■ 94333HSS

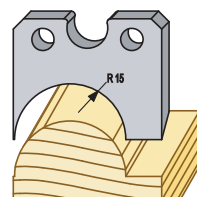

■ 94334HSS

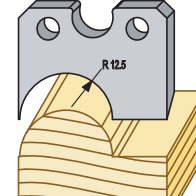

■ 94335HSS

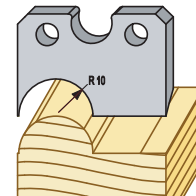

■ 94336HSS

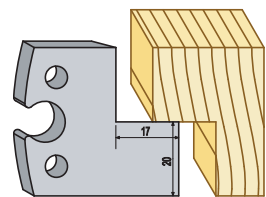

■ 94337HSS

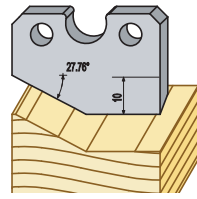

■ 94338HSS

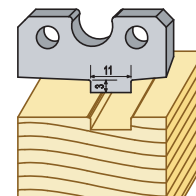

■ 94339HSS

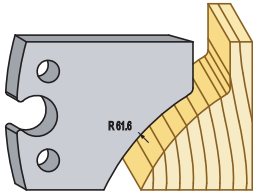

■ 94349HSS

Framtagen för Solohyveln

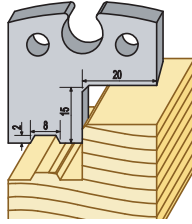

■ 94357HSS

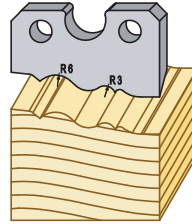

■ 94365HSS

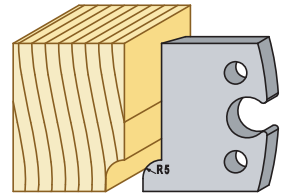

■ 94340HSS

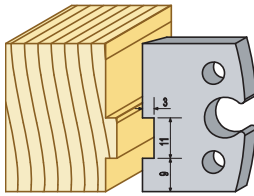

■ 94350HSS

Framtagen för Solohyveln

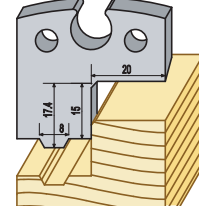

■ 94358HSS

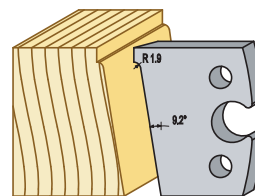

■ 94366HSS

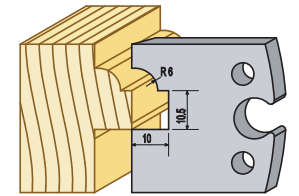

■ 94341HSS

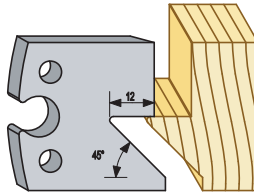

■ 94351HSS

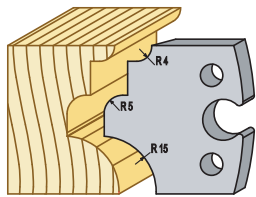

■ 94359HSS

Profildjup 5 mm

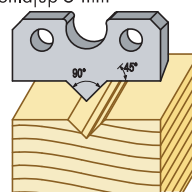

■ 94367HSS

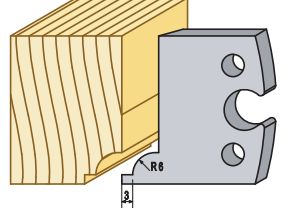

■ 94342HSS

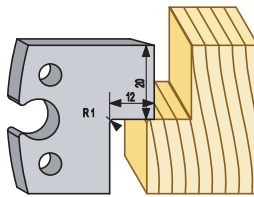

■ 94352HSS

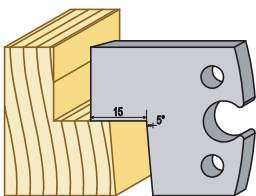

■ 94360HSS

Profildjup 10 mm

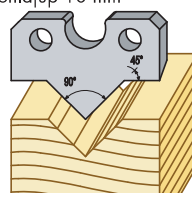

■ 94368HSS

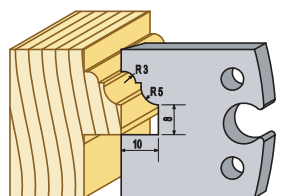

■ 94343HSS

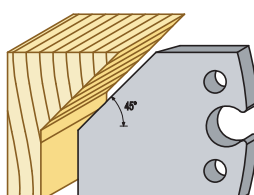

■ 94353HSS

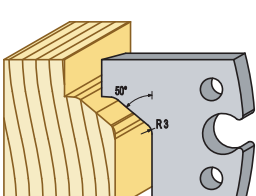

■ 94361HSS

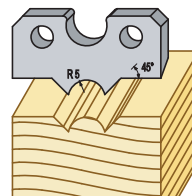

■ 94369HSS

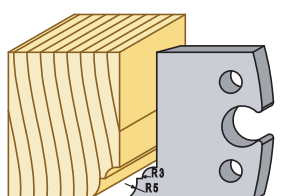

■ 94345HSS

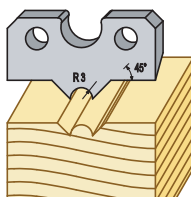

■ 94354HSS

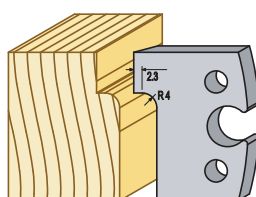

■ 94362HSS

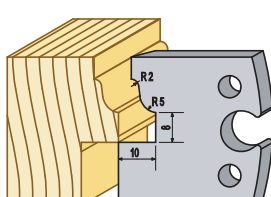

■ 94370HSS

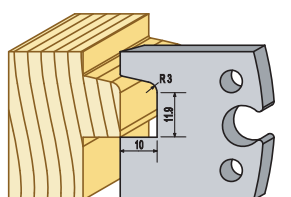

■ 94347HSS

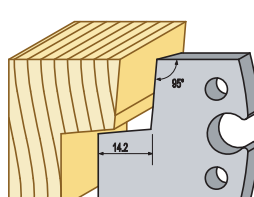

■ 94355HSS

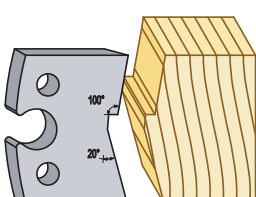

■ 94363HSS

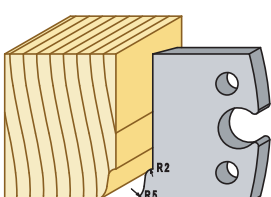

■ 94371HSS

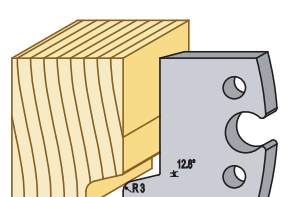

■ 94348HSS

Framtagen för Solohyveln

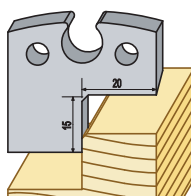

■ 94356HSS

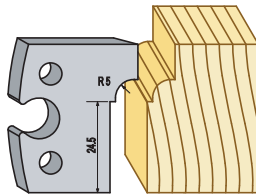

■ 94364HSS

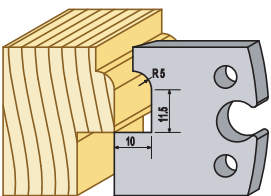

■ 94372HSS

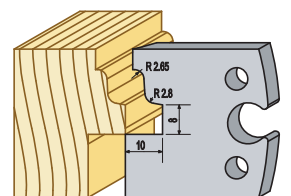

■ 94373HSS

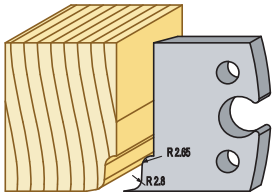

■ 94374HSS

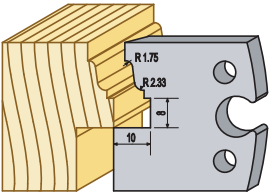

■ 94375HSS

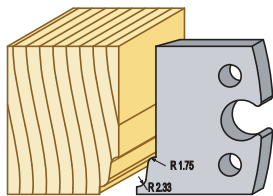

■ 94376HSS

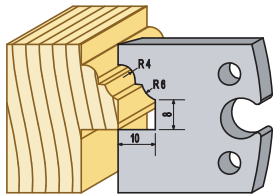

■ 94377HSS

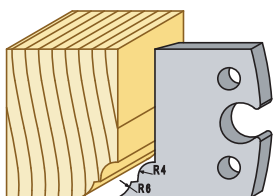

■ 94378HSS

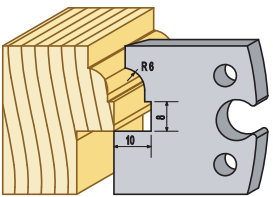

■ 94379HSS

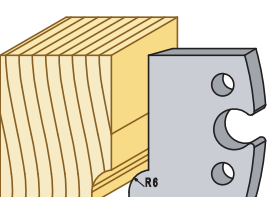

■ 94380HSS

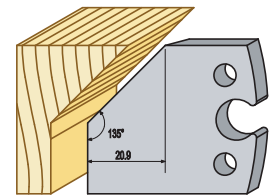

■ 94381HSS

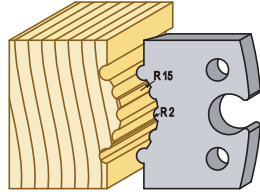

■ 94382HSS

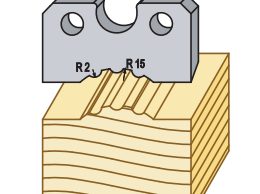

■ 94383HSS

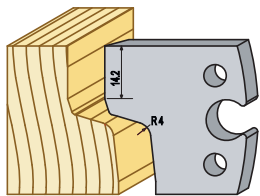

50 mm

■ 9500-20HSS

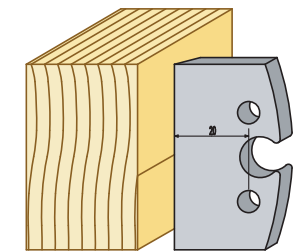

Finns även i 9500-16, 9500-24, 9500-32

■ 95001HSS

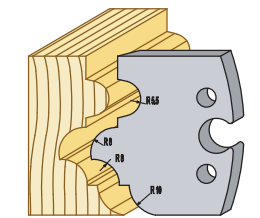

■ 95002HSS

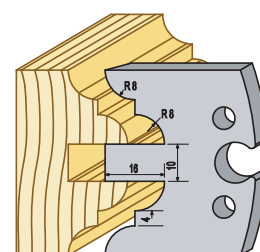

■ 95003HSS

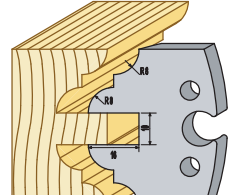

■ 95004HSS

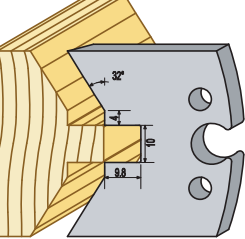

■ 95005HSS

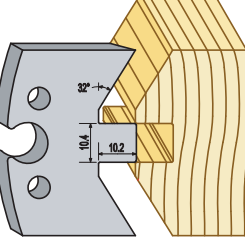

■ 95006HSS

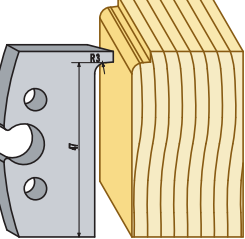

■ 95007HSS

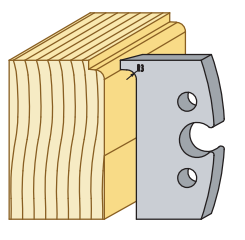

■ 95008HSS

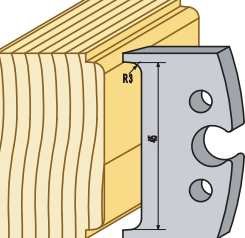

■ 95009HSS

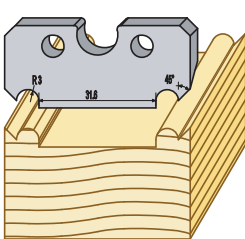

■ 95010HSS

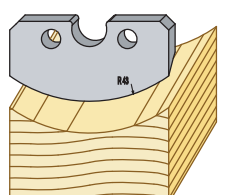

■ 95011HSS

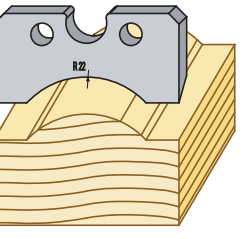

■ 95012HSS

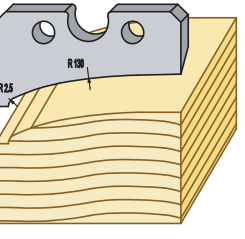

■ 95013HSS

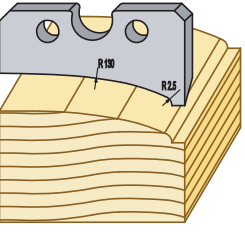

■ 95014HSS

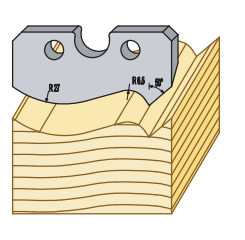

■ 95015HSS

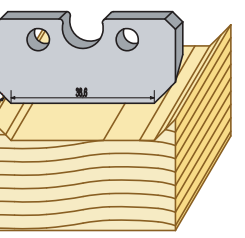

■ 95016HSS

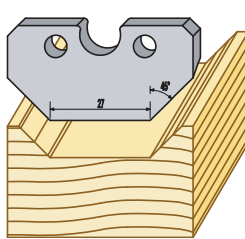

■ 95017HSS

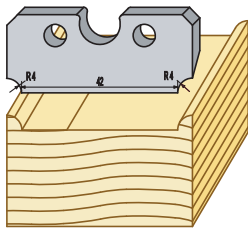

■ 95018HSS

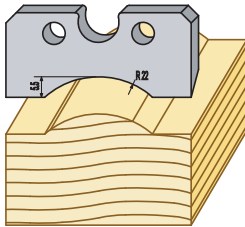

■ 95019HSS

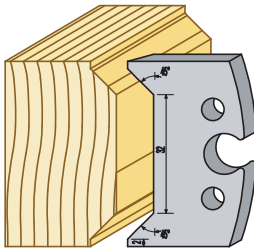

■ 95020HSS

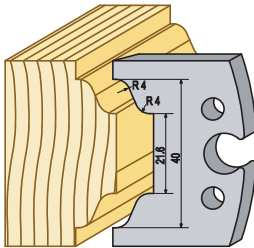

■ 95021HSS

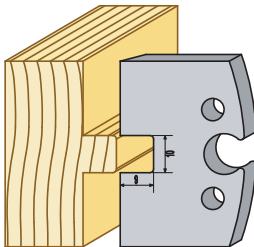

■ 95022HSS

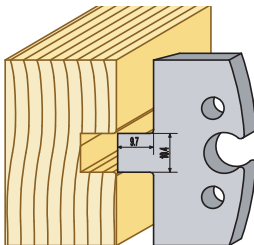

■ 95023HSS

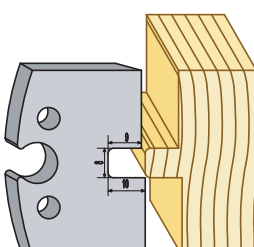

■ 95024HSS

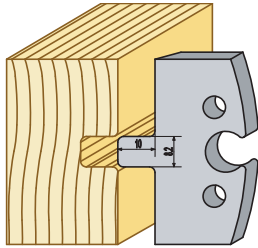

■ 95025HSS

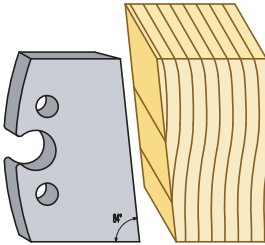

■ 95026HSS

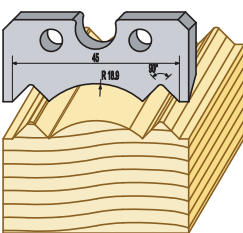

■ 95027HSS

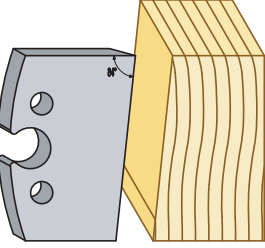

■ 95028HSS

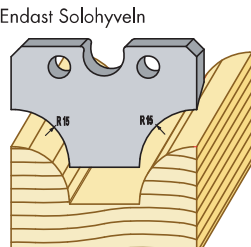

■ 95029HSS

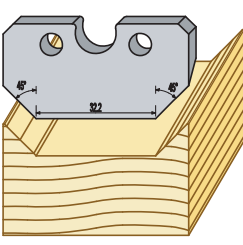

■ 95030HSS

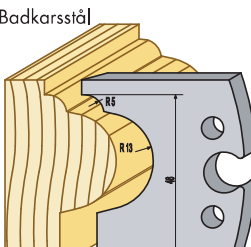

■ 95031HSS

Badkarstål

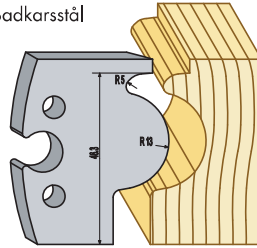

■ 95032HSS

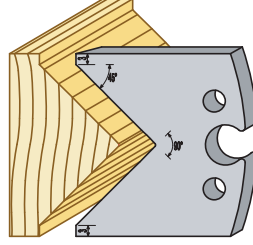

■ 95033HSS

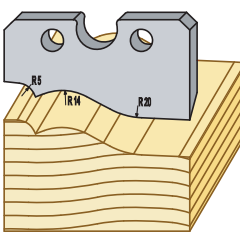

■ 95034HSS

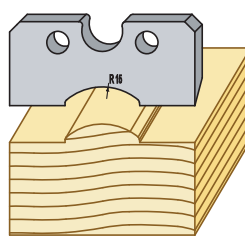

■ 95035HSS

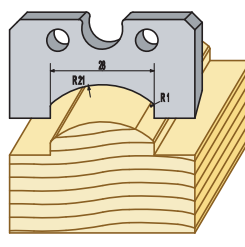

■ 95036HSS

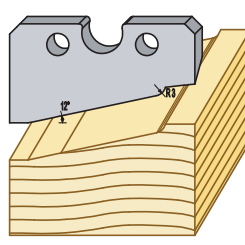

■ 95038HSS

Badkarstål

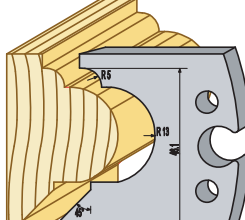

■ 95039HSS

Badkarstål

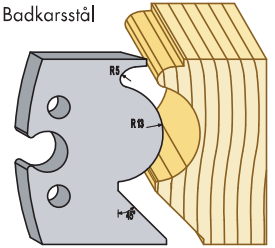

■ 95040HSS

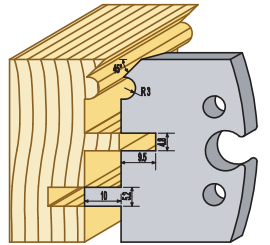

■ 95041HSS

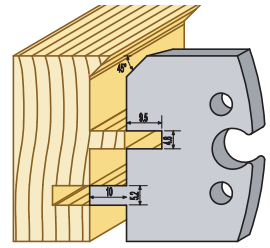

■ 95042HSS

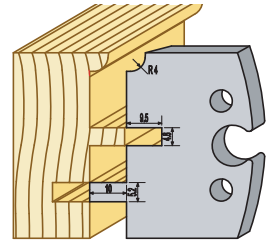

■ 95043HSS

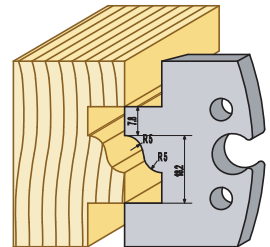

■ 95044HSS

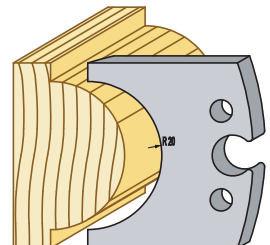

■ 95045HSS

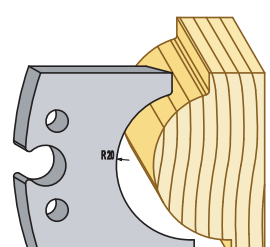

■ 95046HSS

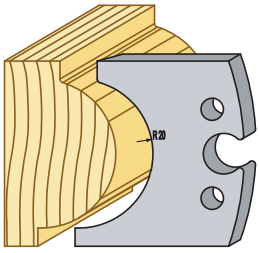

■ 95047HSS

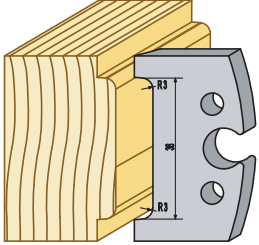

■ 95048HSS

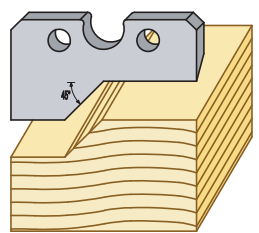

■ 95049HSS

Badkarsstål

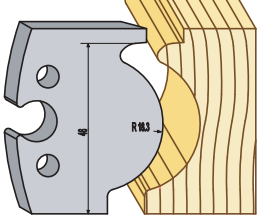

■ 95050HSS

Badkarsstål

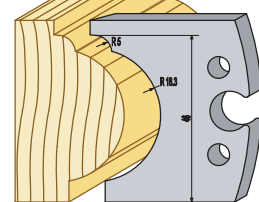

■ 95051HSS

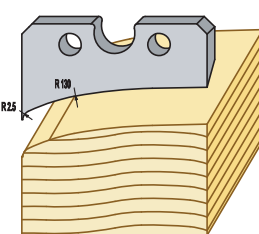

■ 95052HSS

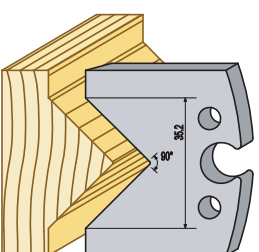

■ 95053HSS

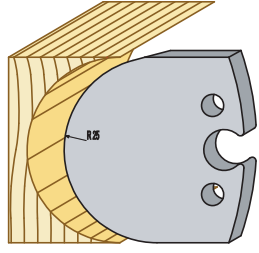

■ 95054HSS

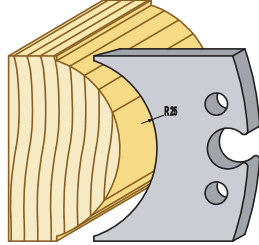

■ 95055HSS

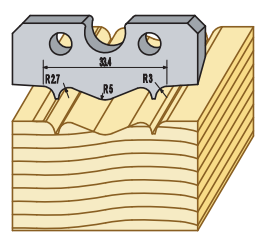

■ 95056HSS

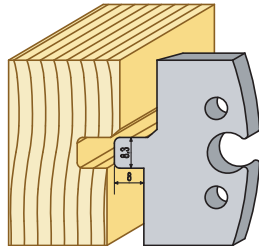

■ 95057HSS

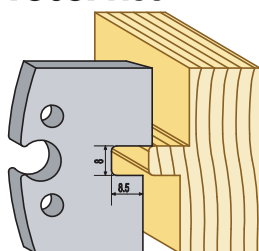

■ 95058HSS

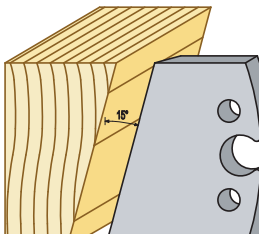

■ 95059HSS

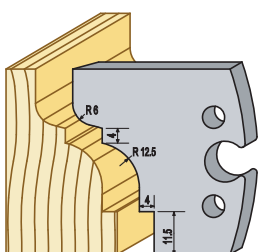

■ 95060HSS

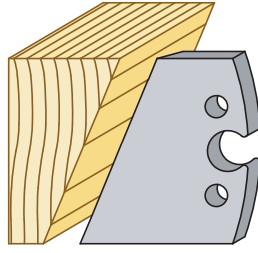

■ 95061HSS

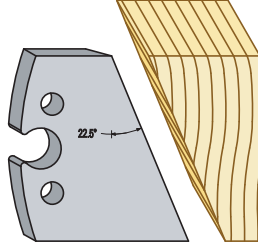

■ 95062HSS

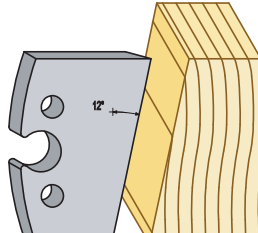

■ 95063HSS

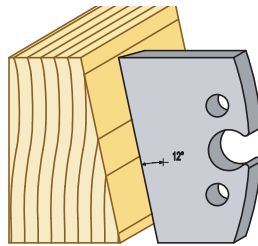

■ 95064HSS

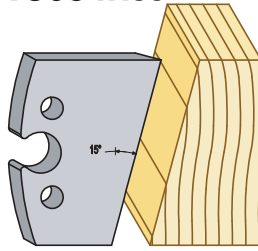

■ 95065HSS

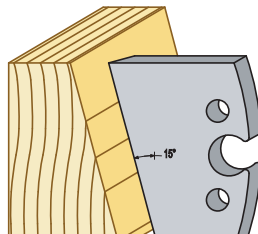

■ 95066HSS

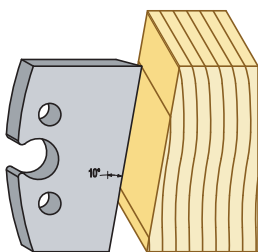

■ 95067HSS

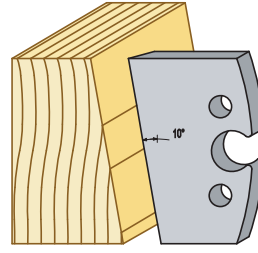

■ 95069HSS

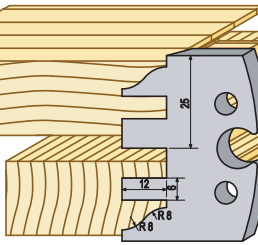

■ 95070HSS

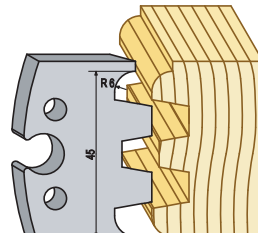

■ 95071HSS

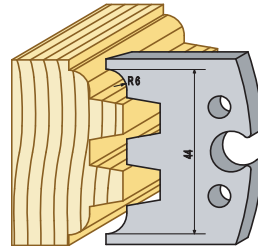

■ 95072HSS

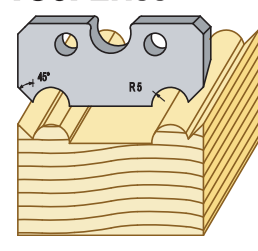

■ 95073HSS

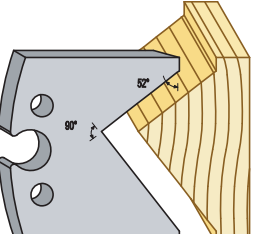

■ 95074HSS

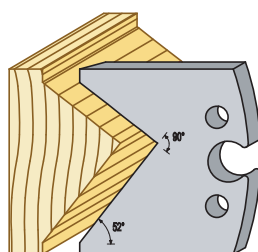

■ 95075HSS

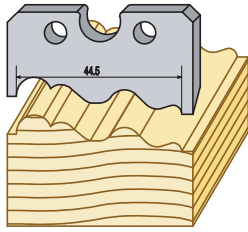

■ 95076HSS

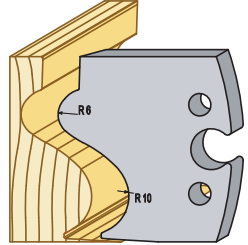

■ 95077HSS

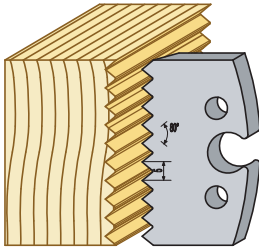

■ 95078HSS

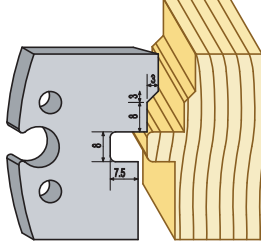

■ 95079HSS

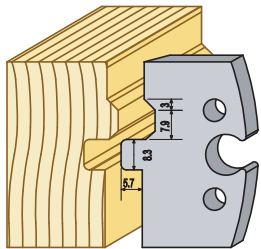

■ 95080HSS

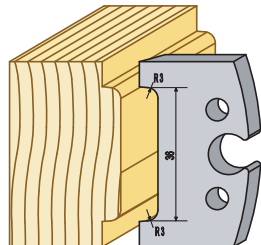

■ 95082HSS

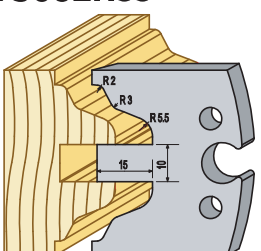

■ 95083HSS

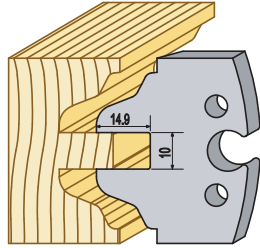

**60 mm**

■ 9600-20HSS

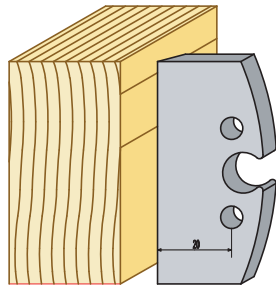

Finns även i 9600-16, 9600-24, 9600-32

■ 96001HSS

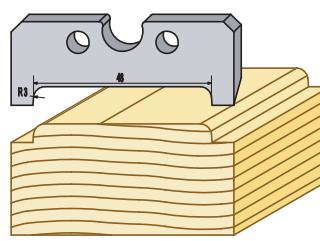

■ 96002HSS

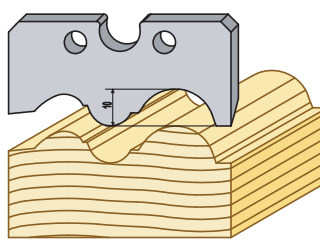

■ 96003HSS

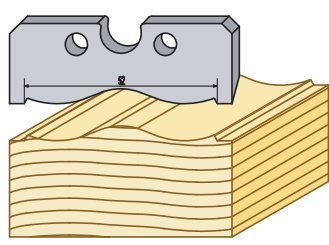

■ 96004HSS

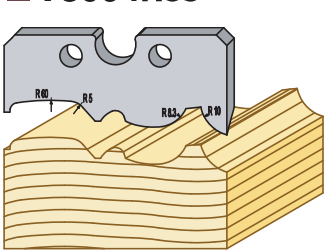

■ 96005HSS

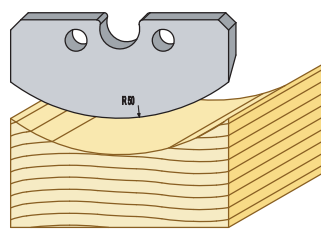

■ 96006HSS

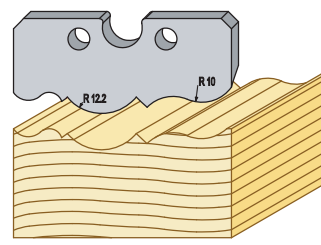

■ 96007HSS

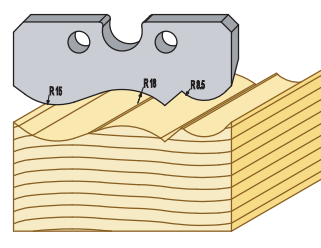

■ 96008HSS

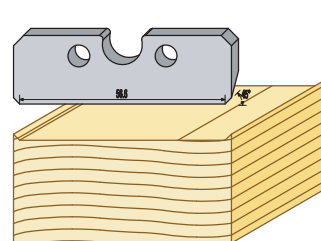

■ 96009HSS

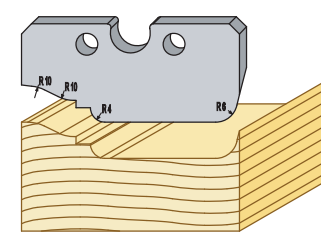

■ 96010HSS

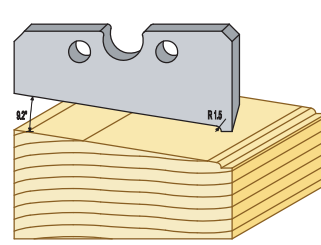

■ 96011HSS

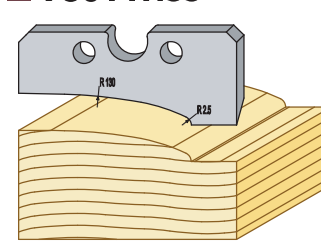

■ 96014HSS

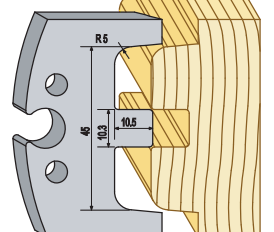

■ 96015HSS

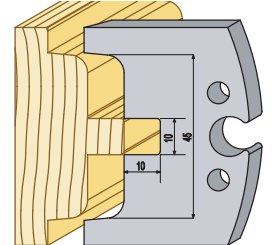

■ 96017HSS

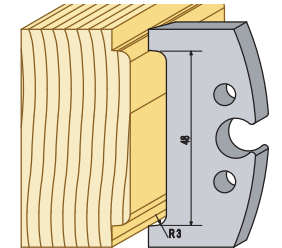

■ 96018HSS

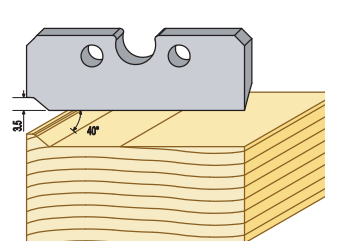

■ 96019HSS

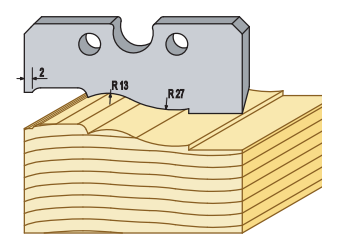

■ 96020HSS

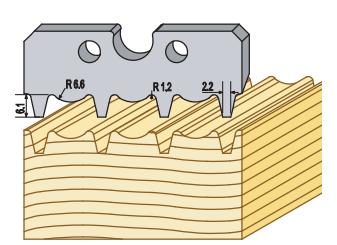

■ 96021HSS

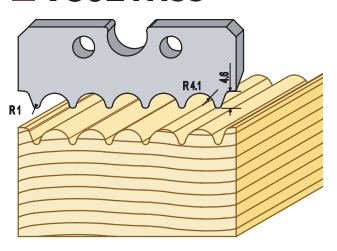

■ 96022HSS

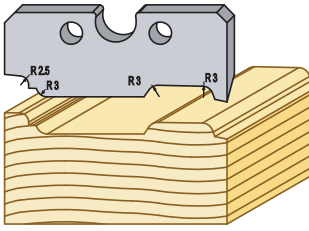

■ 98005HSS

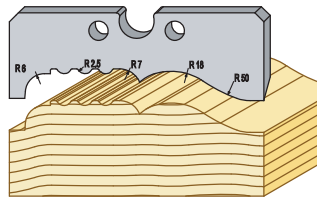

■ 91004HSS

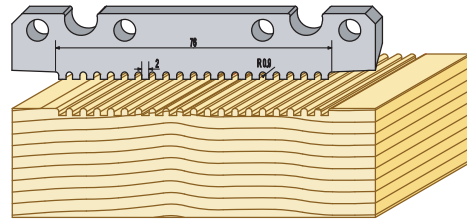

80 mm

■ 98002HSS

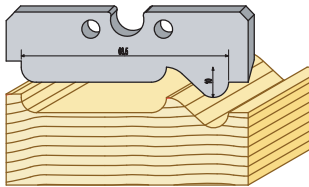

■ 98006HSS

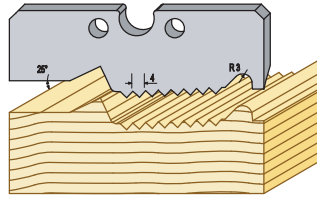

■ 91010HSS Morapanel 95 mm

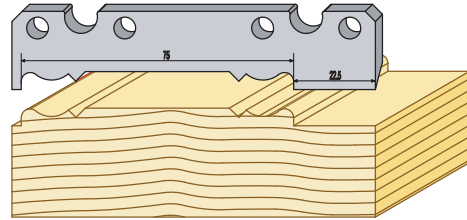

■ 98003HSS

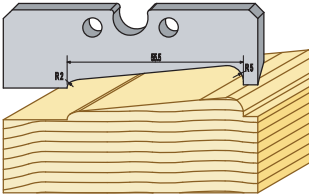

■ 98007HSS

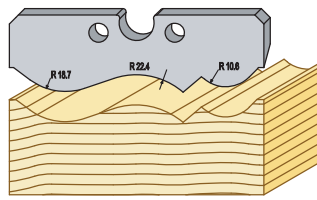

■ 91011HSS Vågig Morapanel 95 mm

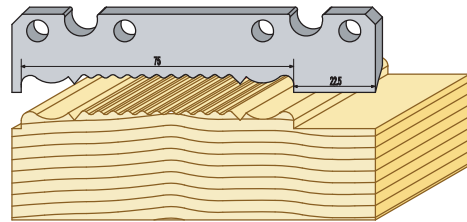

■ 98004HSS

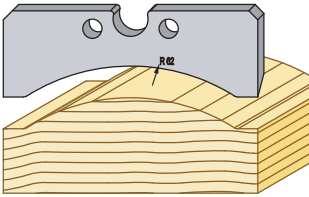

■ 98008HSS

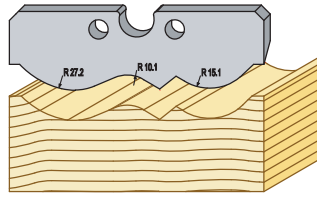

■ 91012HSS Fasadpanel 95 mm

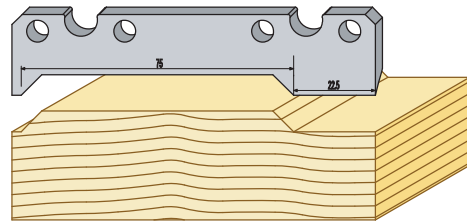

100 mm

■ 91001HSS

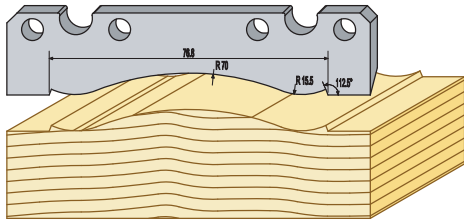

■ 91013HSS Vågig Fasadpanel 95 mm

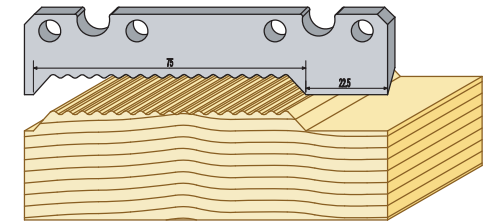

■ 91002HSS

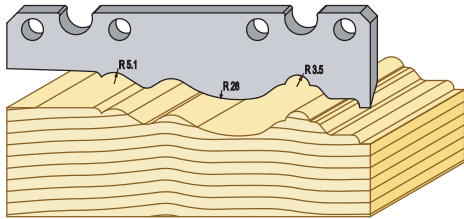

■ 91014HSS Avrundad panel 95 mm

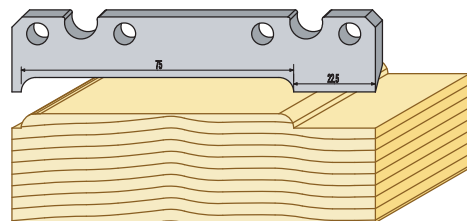

■ 91003HSS

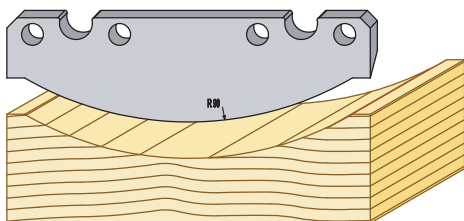

■ 91015HSS Vågig avrundad panel 95 mm

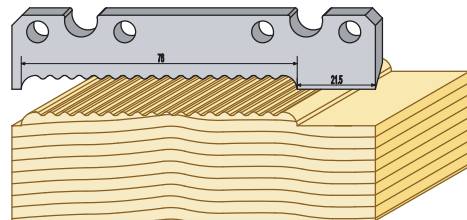

■ **91016HSS** Pärlspont 95 mm

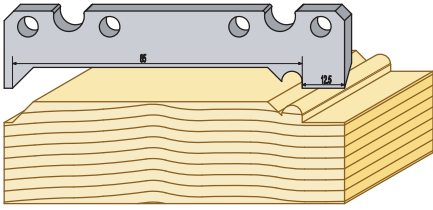

■ **91020HSS**

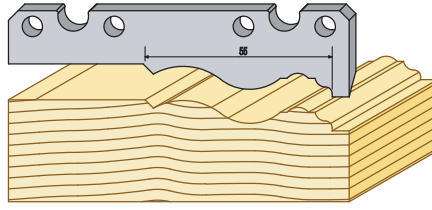

■ **91023HSS**

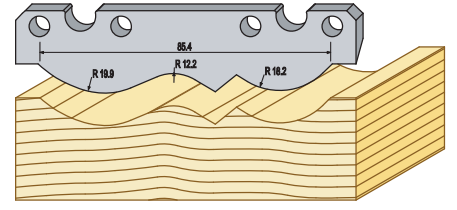

■ **91017HSS** Vågig pärlspont 95 mm

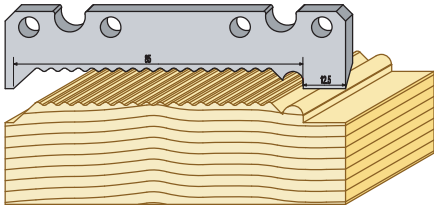

■ **91021HSS**

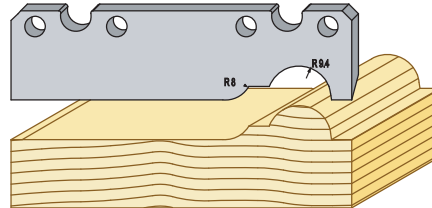

■ **91024HSS**

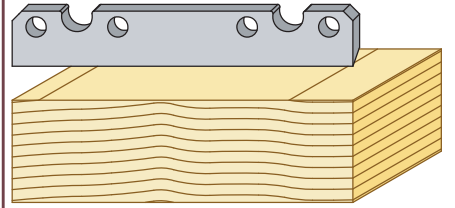

■ **91018HSS** Stockpanel 95 mm

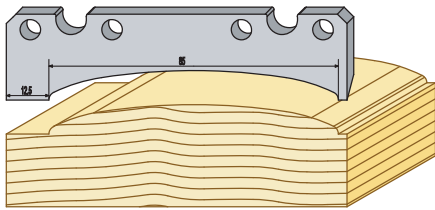

■ **91022HSS**

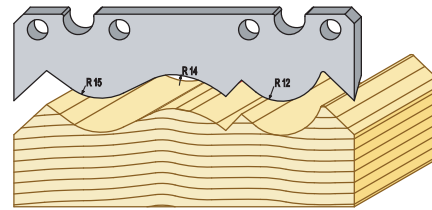

■ **91025HSS**

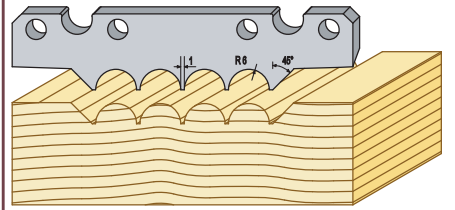

## 130 mm

■ **91301HSS** Svanhalstaklist

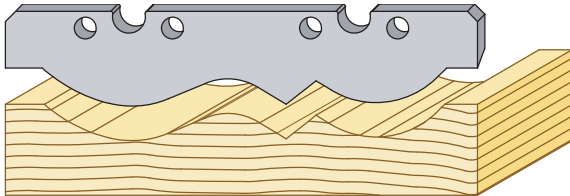

■ **91305HSS**

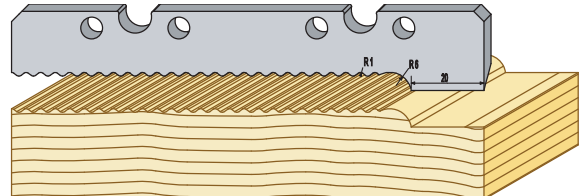

■ **91302HSS**

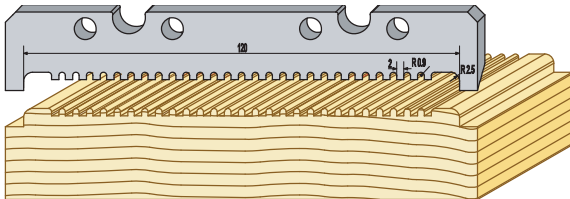

■ **91306HSS**

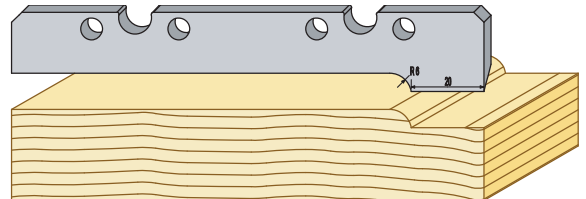

■ **91303HSS**

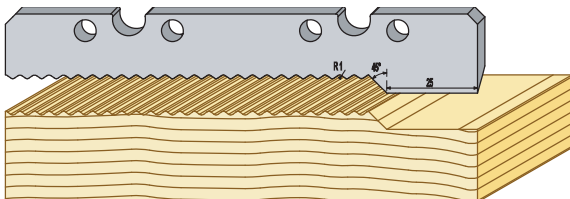

■ **91307HSS**

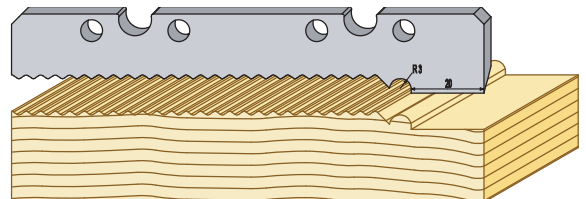

■ **91304HSS**

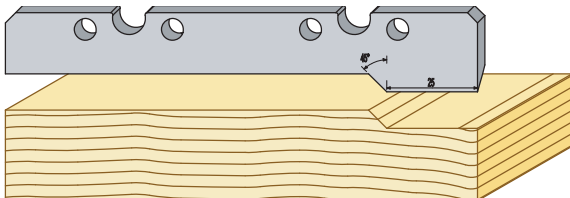

■ **91308HSS**

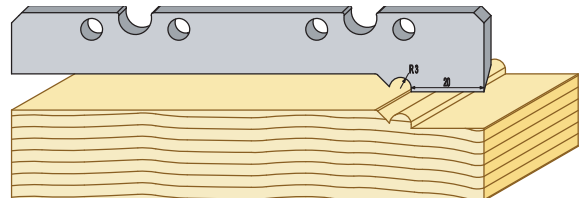



■ **91309HSS**

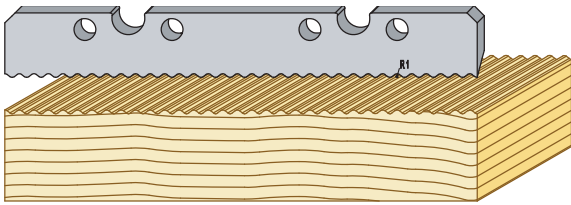

■ **91310HSS** Morapanel 120 mm

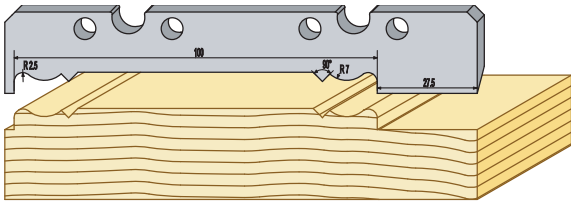

■ **91311HSS** Vågig Morapanel 120 mm

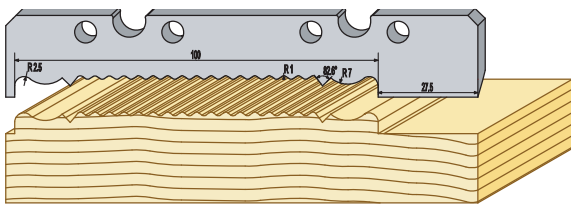

■ **91312HSS** Faspanel 120 mm

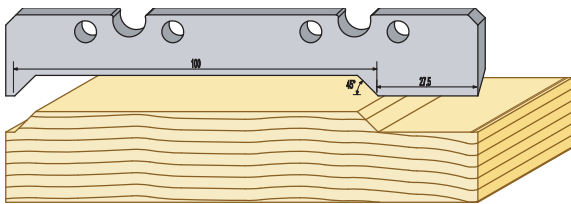

■ **91313HSS** Vågig faspanel 120 mm

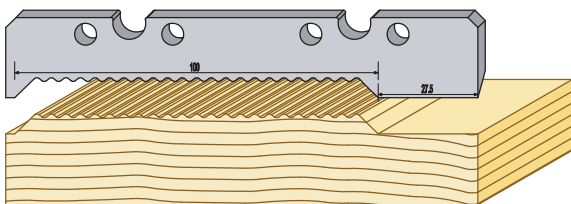

■ **91314HSS** Avrundad panel 120 mm

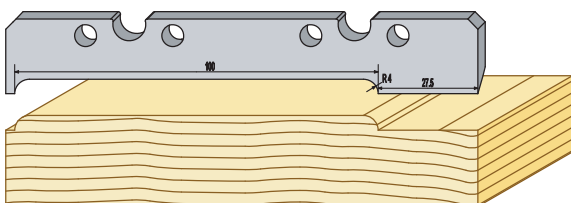

■ **91315HSS** Vågig avrundad panel 120 mm

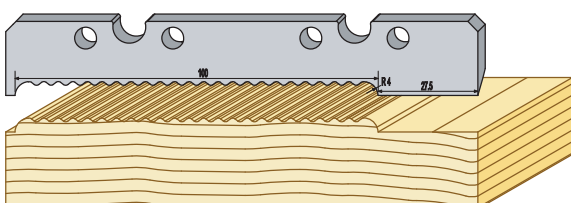

■ **91316HSS** Pärlspont 120 mm

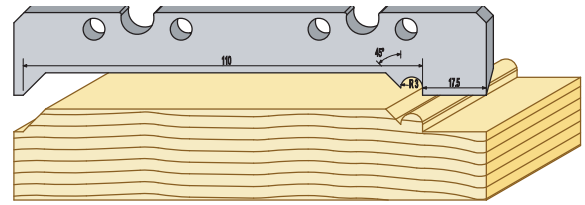

■ **91317HSS** Vågig pärlspont 120 mm

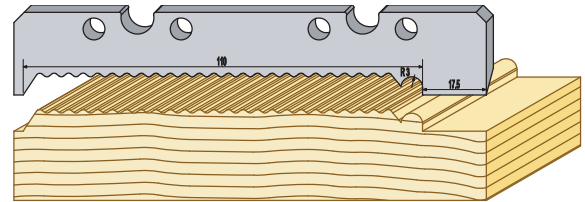

■ **91318HSS** Stockpanel 120mm

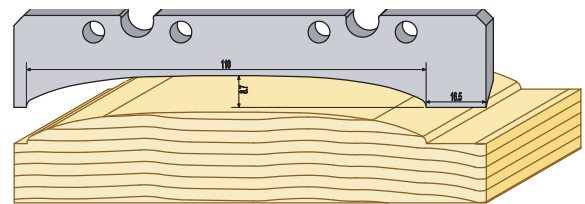

■ **91319HSS** "Sågad" yta

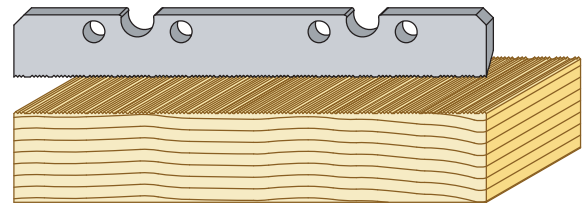

■ **91320HSS**

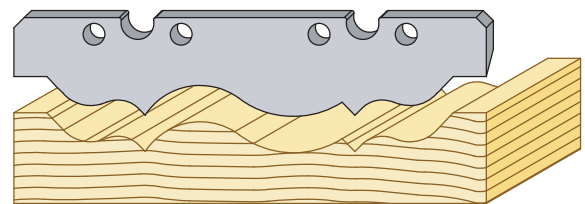

■ **91321HSS**

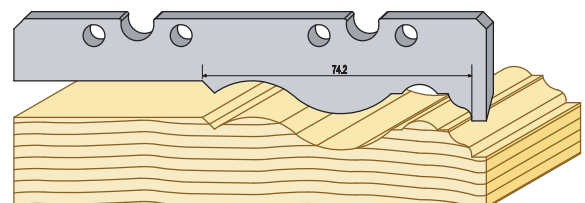

■ **91323HSS**

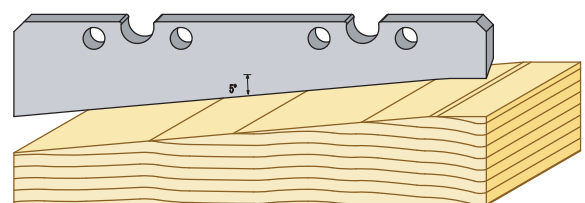

# Profilstål i verktygsstål 40 x 4 mm

**9000**

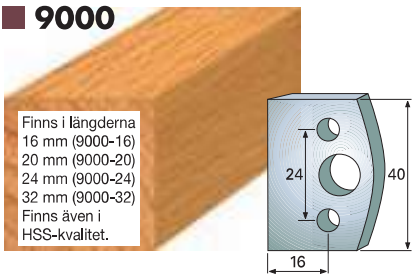

**9001**

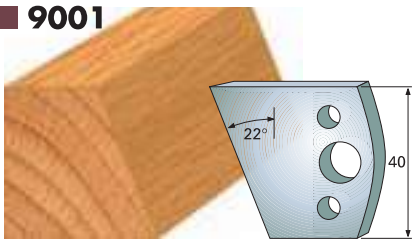

**9002**

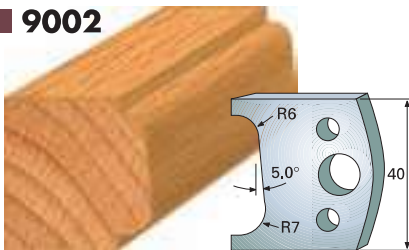

**9003**

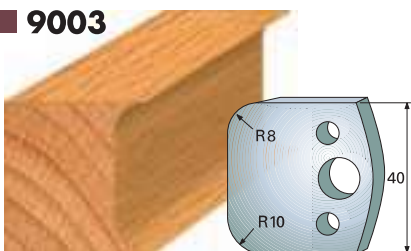

**9004**

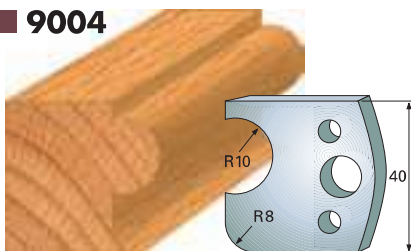

**9005**

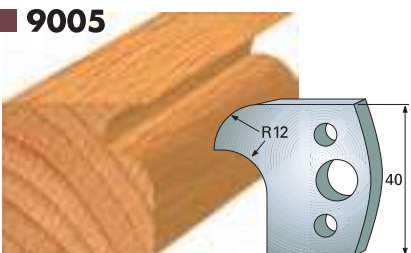

**9006**

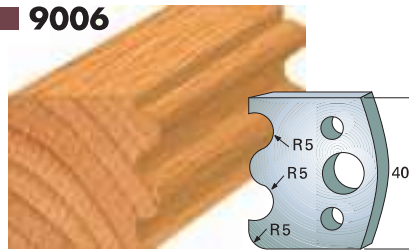

**9007**

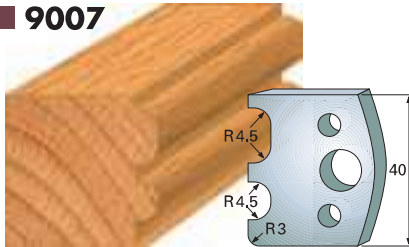

**9008**

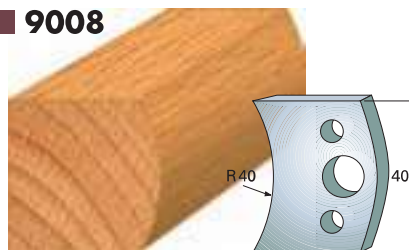

**9009**

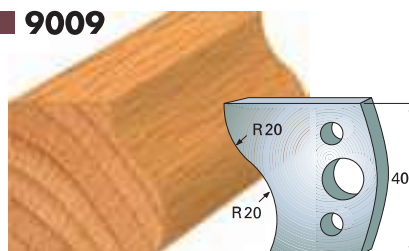

**9010**

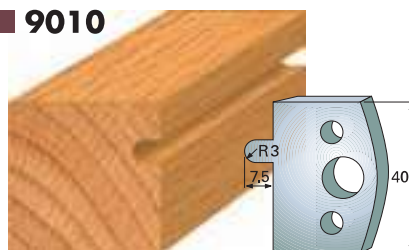

**9011**

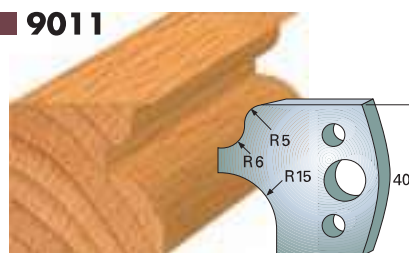

**9012**

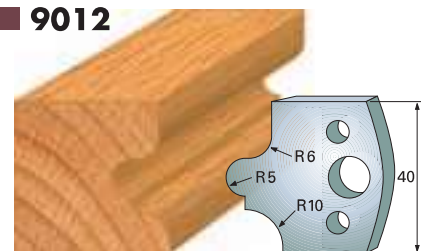

**9013**

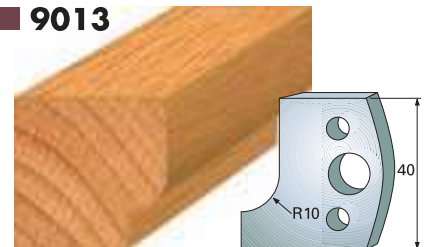

**9014**

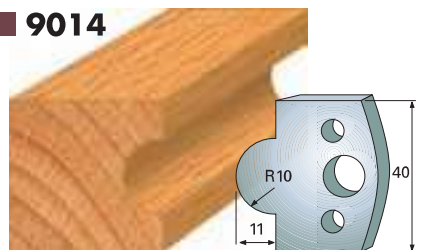

**9015**

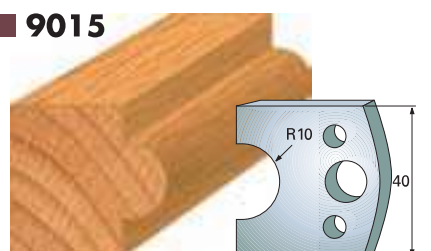

**9016**

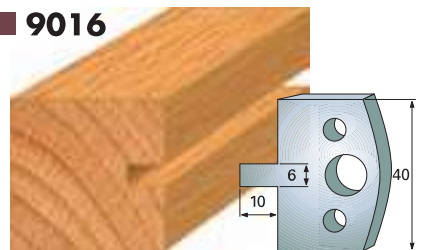

**9017**

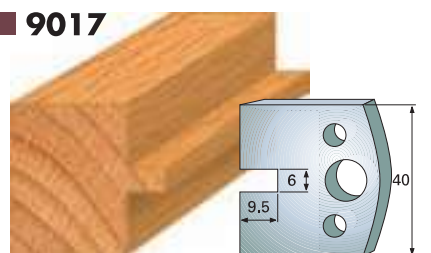

■ 9018

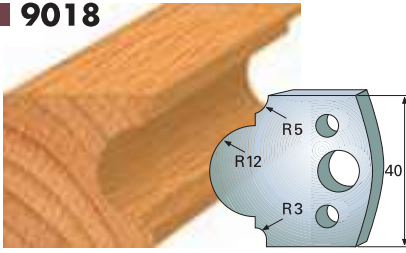

■ 9019

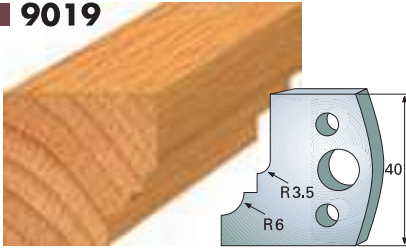

■ 9020

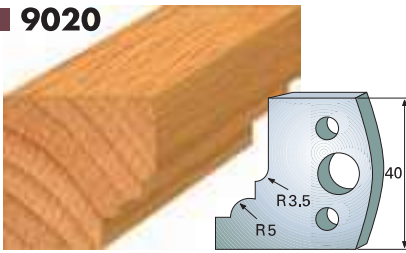

■ 9021

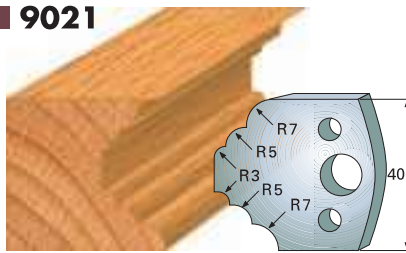

■ 9022

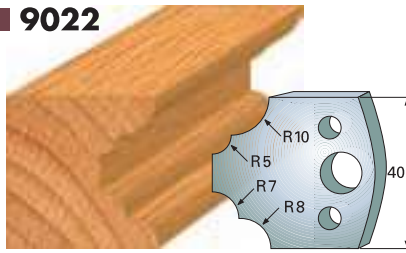

■ 9023

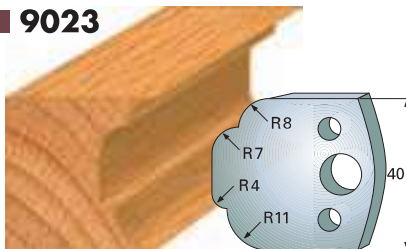

■ 9024

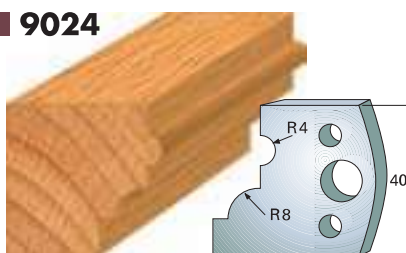

■ 9025

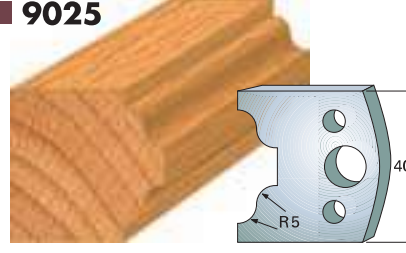

■ 9026

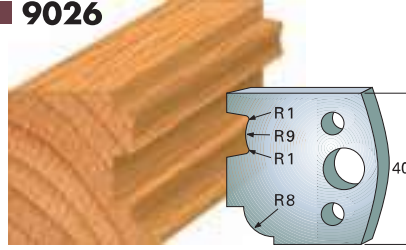

■ 9027

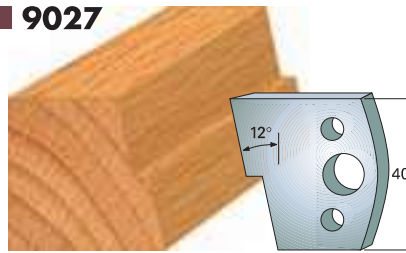

■ 9028



■ 9029

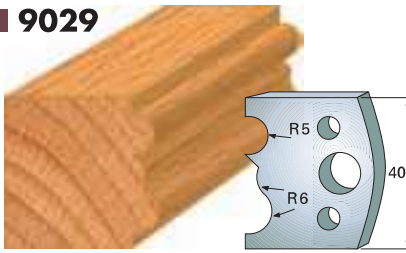

■ 9030

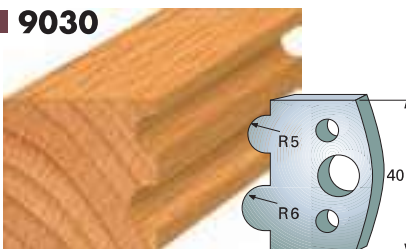

■ 9031

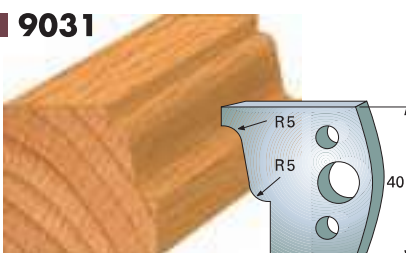

■ 9032

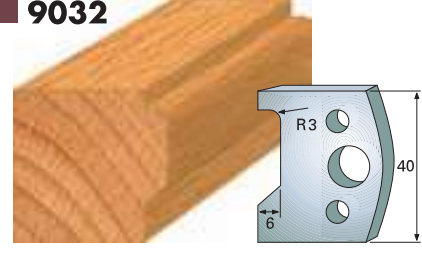

■ 9033

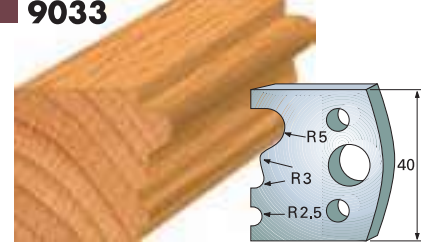

■ 9034

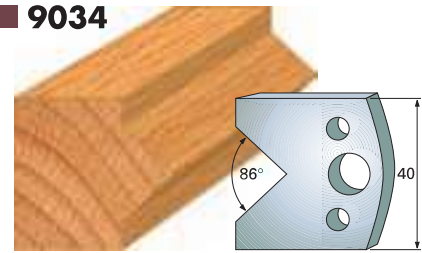

■ 9035

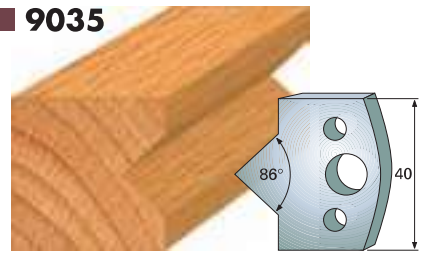

■ 9036

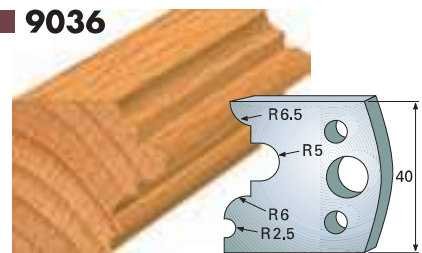

■ 9037

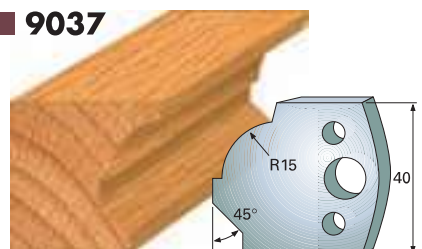

■ 9038

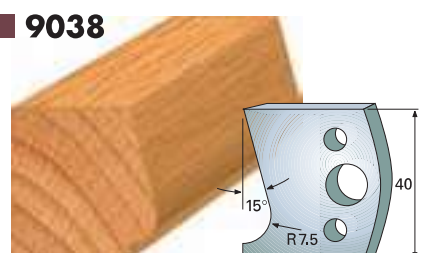

Hittar du inte profilen som passar dig, se specialtillverkning på sidan 135.

9039

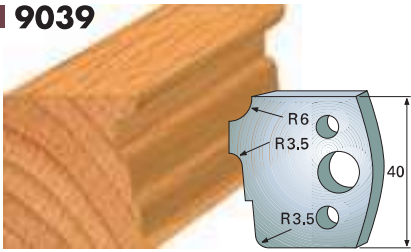

9046

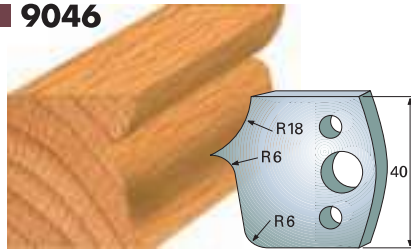

9053

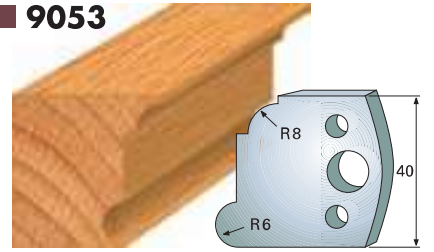

9040

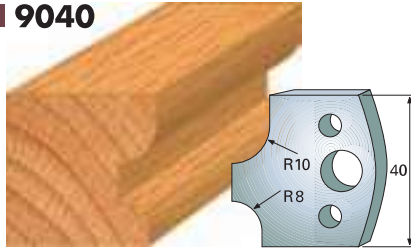

9047

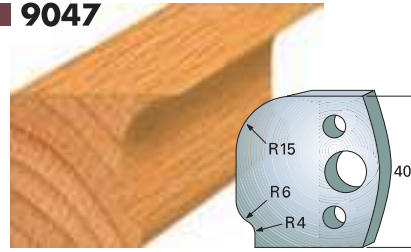

9054

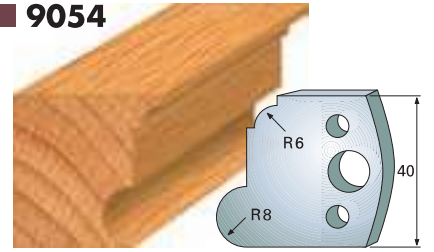

9041

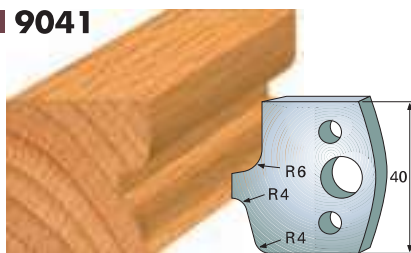

9048

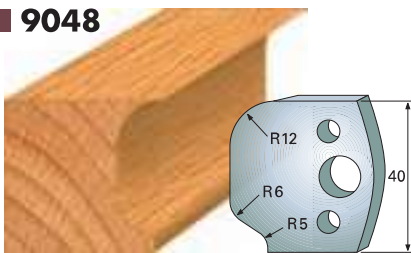

9055

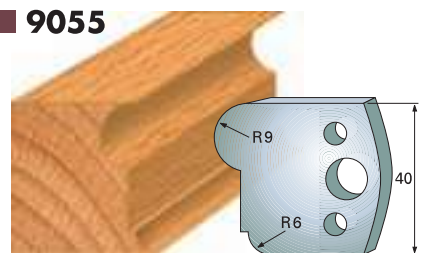

9042

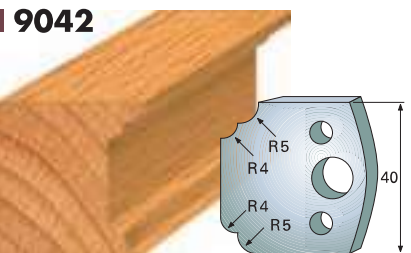

9049

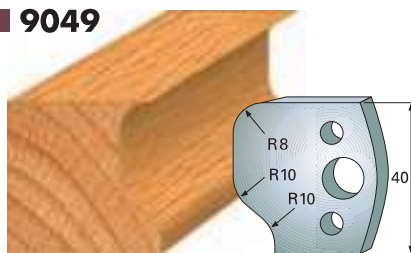

9056

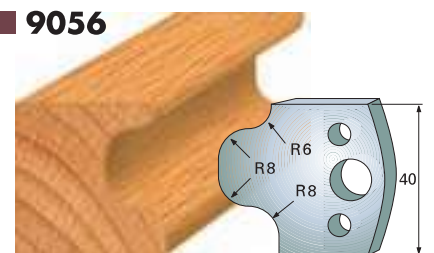

9043

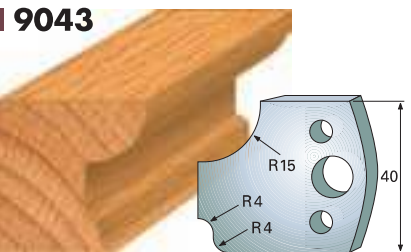

9050

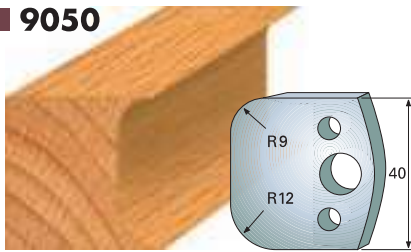

9057

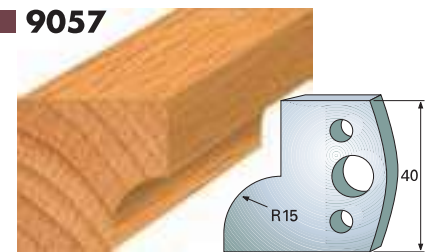

9044

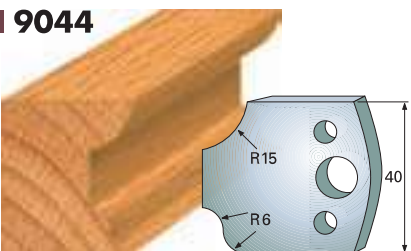

9051

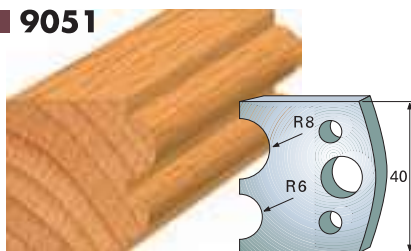

9058

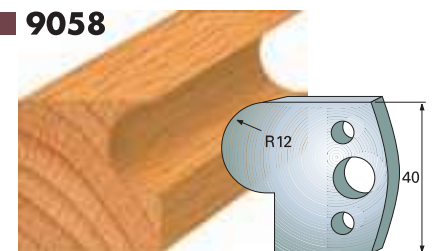

9045

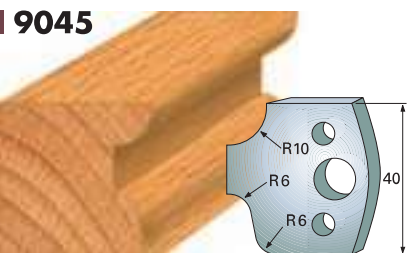

9052

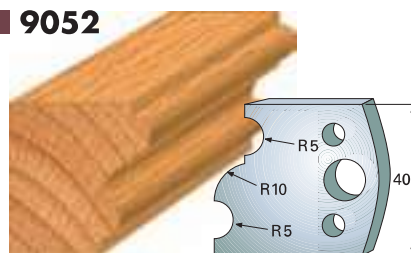

9059

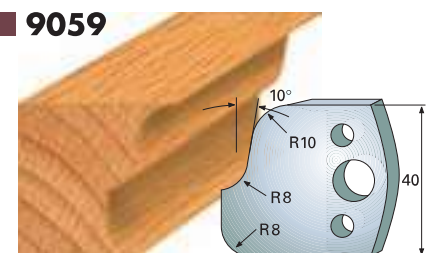

■ 9060

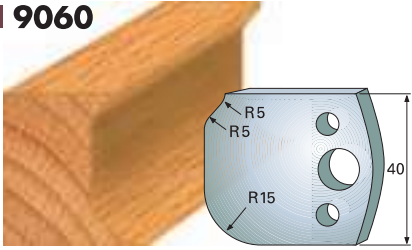

■ 9067

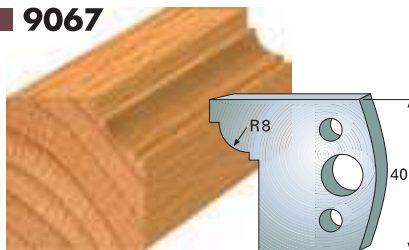

■ 9074

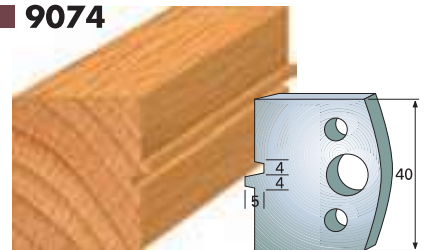

■ 9061

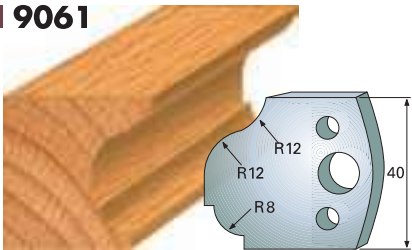

■ 9068

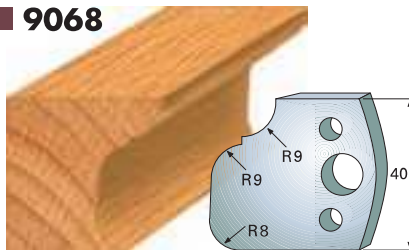

■ 9075

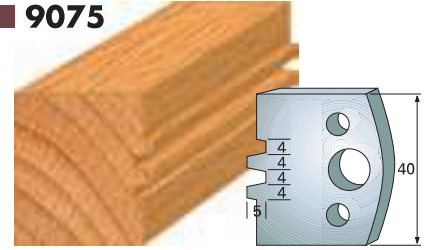

■ 9062

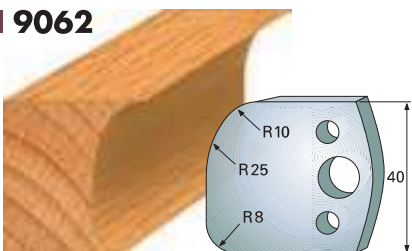

■ 9069

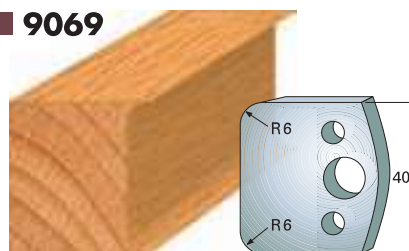

■ 9076

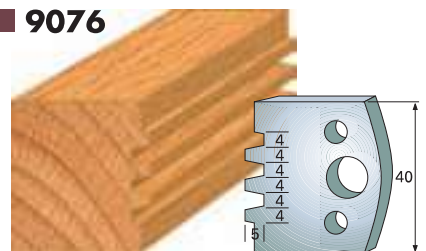

■ 9063

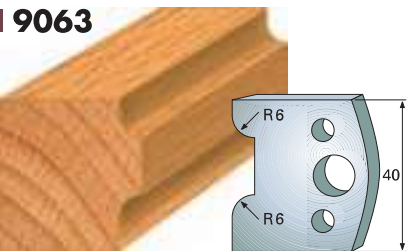

■ 9070

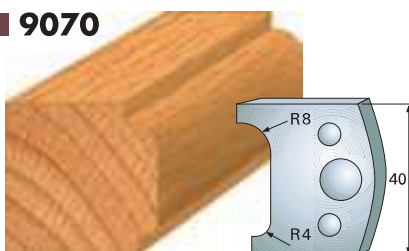

■ 9077

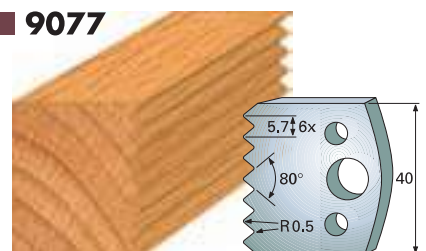

■ 9064

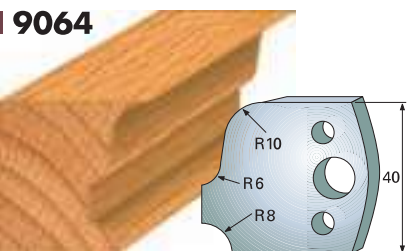

■ 9071

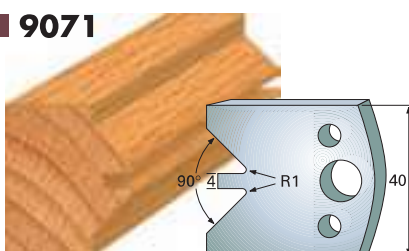

■ 9078

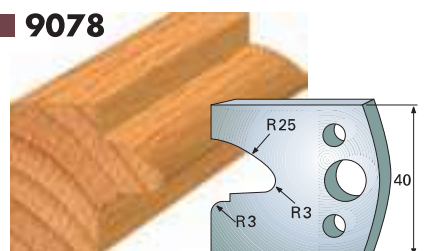

■ 9065

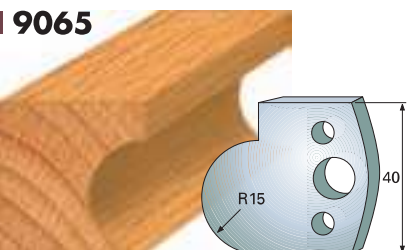

■ 9072

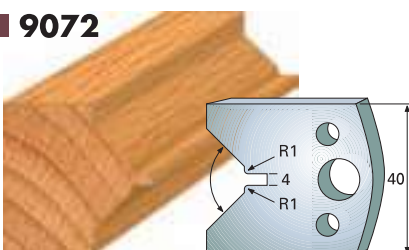

■ 9079

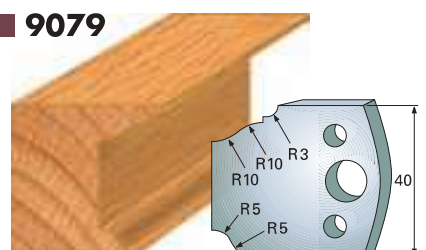

■ 9066

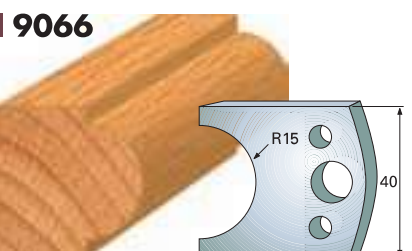

■ 9073

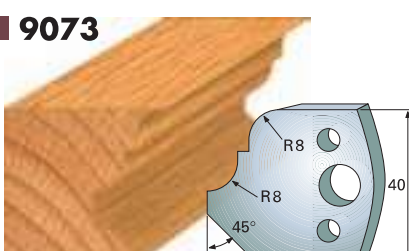

■ 9080

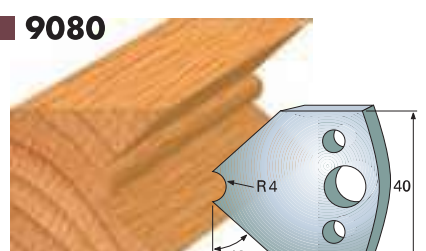

Hittar du inte profilen som passar dig, se specialtillverkning på sidan 135.

9081

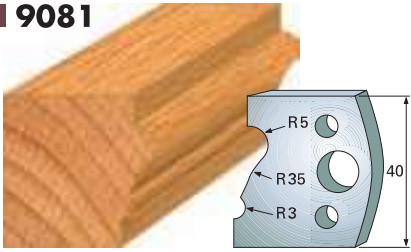

9082

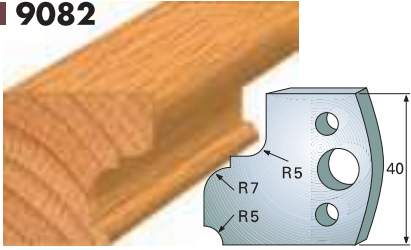

9083

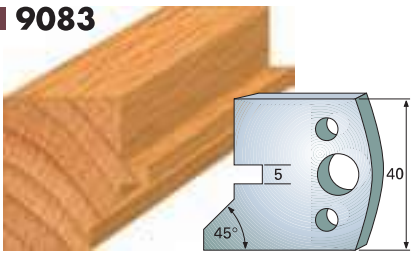

9084

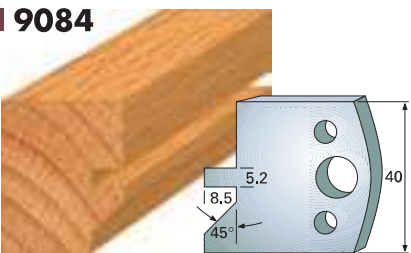

9085

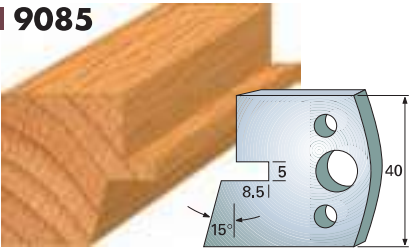

9086

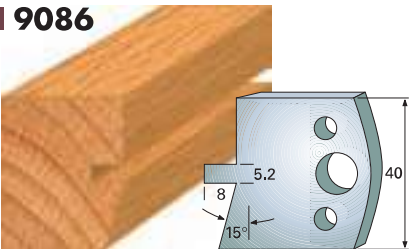

9087

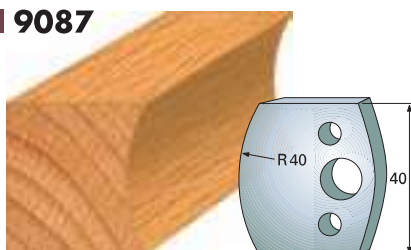

9088

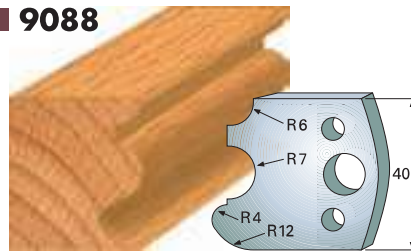

9089

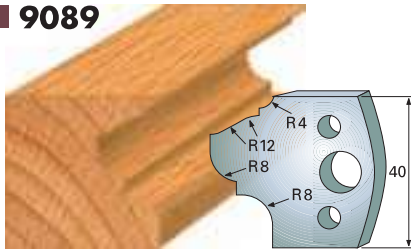

9090

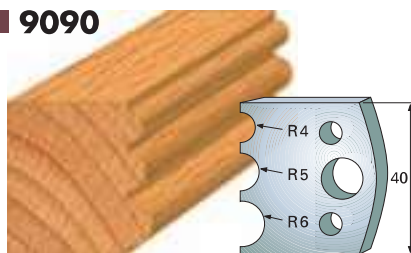

9091-1

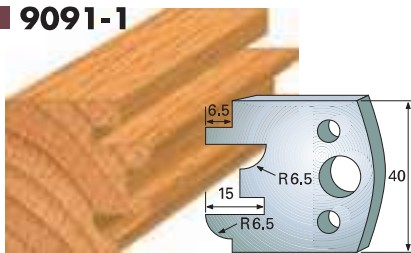

9091-2

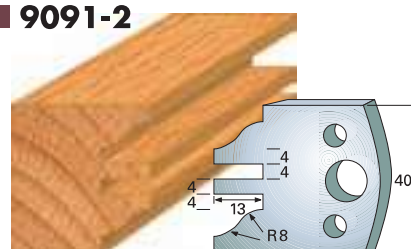

9091-3

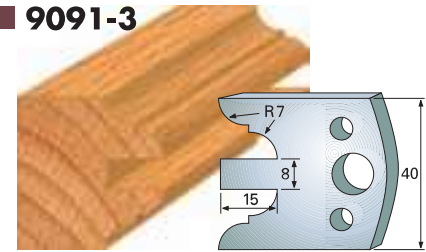

9091-4

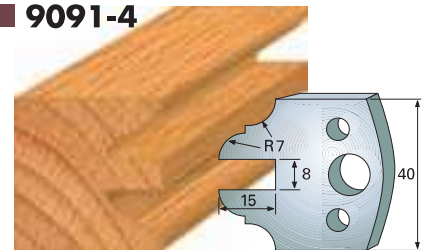

9092

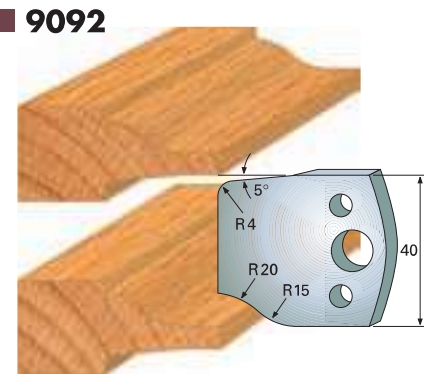

90101

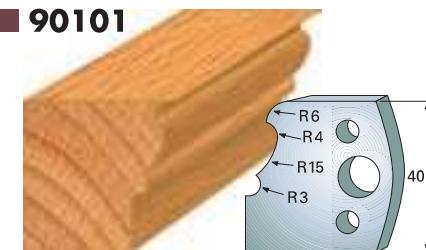

90102

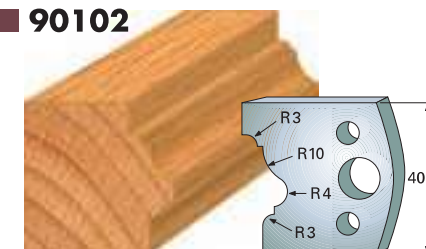

90103

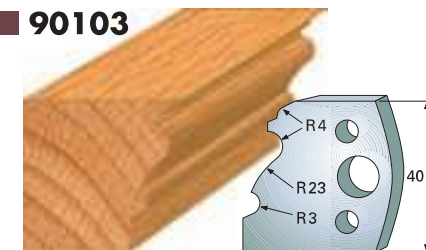

■ 90104

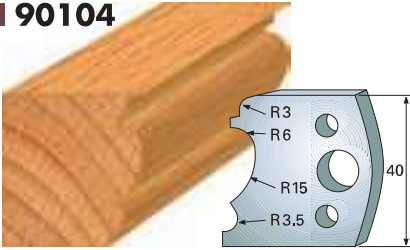

■ 90111

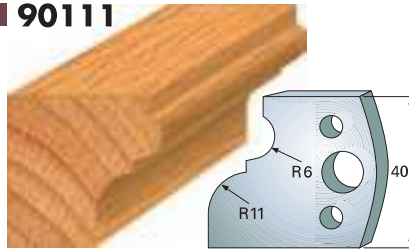

■ 90118

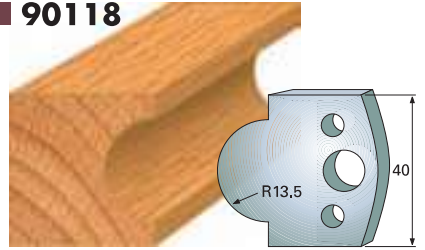

■ 90105

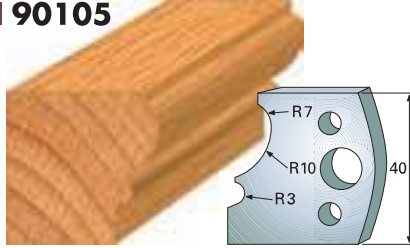

■ 90112

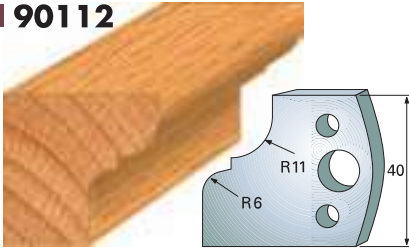

■ 90119

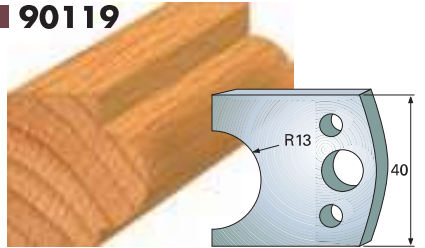

■ 90106

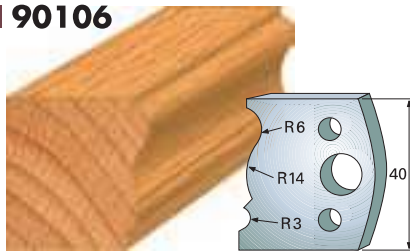

■ 90113

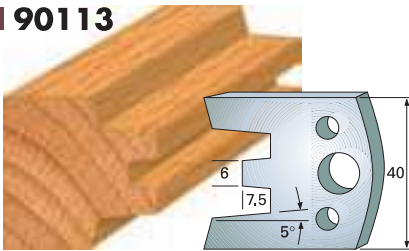

■ 90120

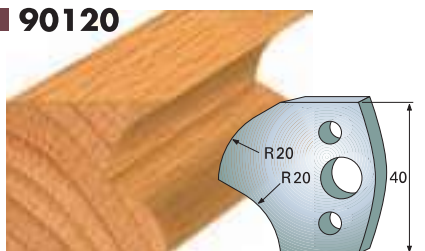

■ 90107

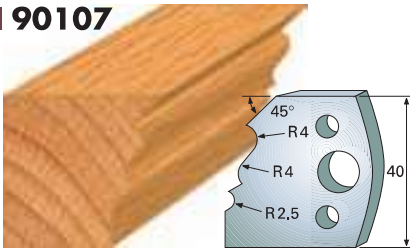

■ 90114

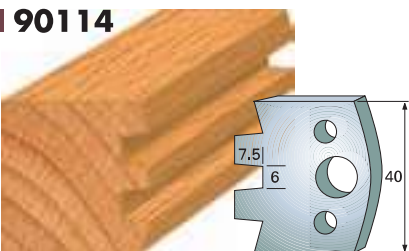

■ 90121



■ 90108

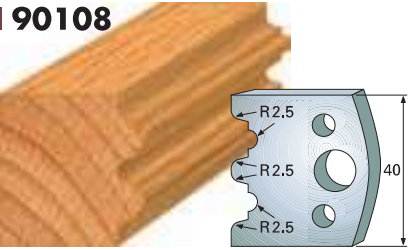

■ 90115

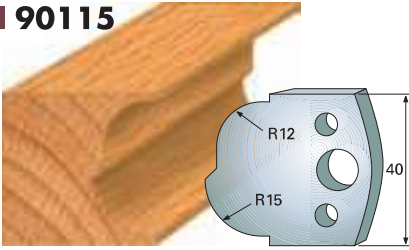

■ 90122

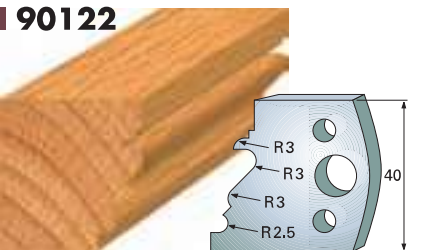

■ 90109

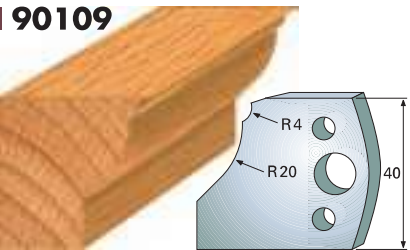

■ 90116

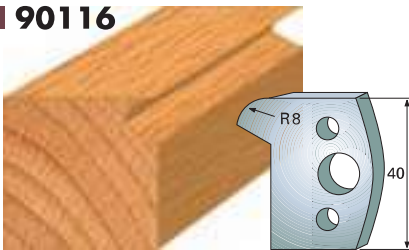

■ 90123

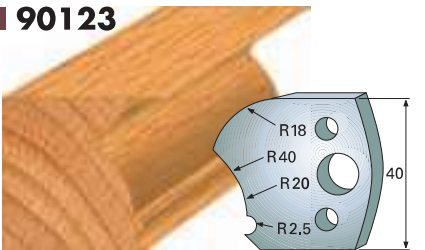

■ 90110

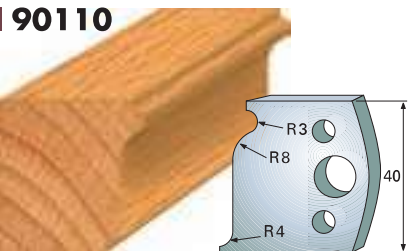

■ 90117

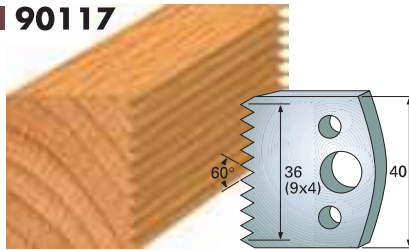

■ 90124

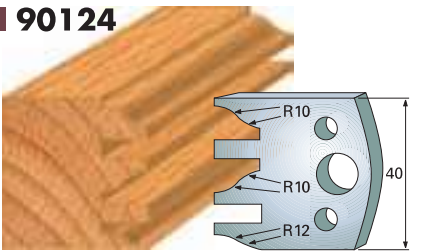

**90127**

Allmogestål

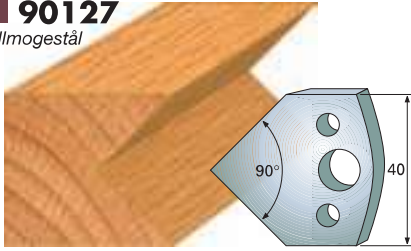
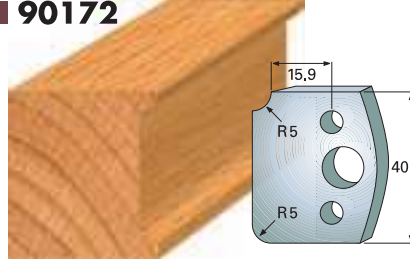
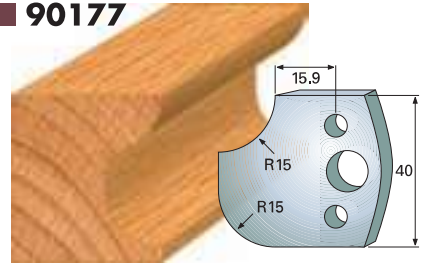
**90172****90177****90128**

Allmogestål

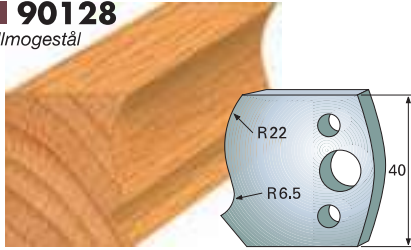
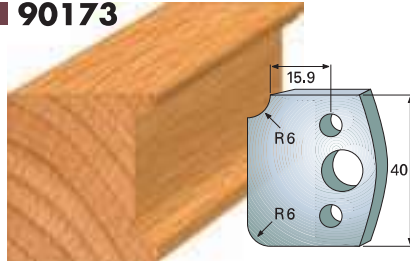
**90173****TB90-Allmoge**

Allmogeprofilstålen (90127, 90128, 90129) som sats



Taklist 52x22 mm



Foder 70x15 mm



Golvlist 95x15 mm

**90129**

Allmogestål

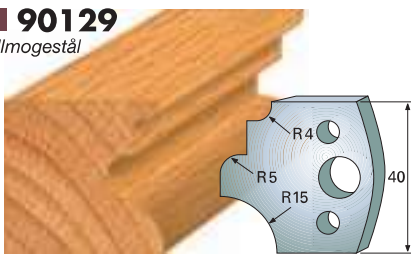
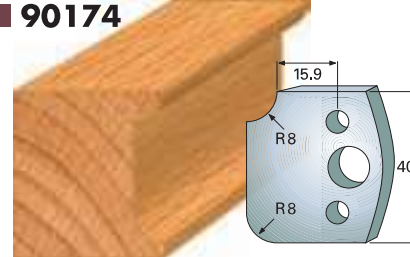
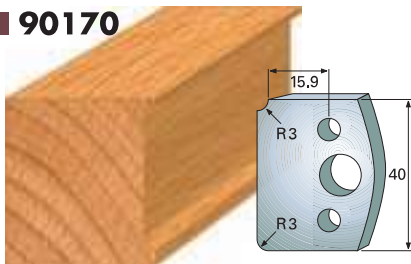
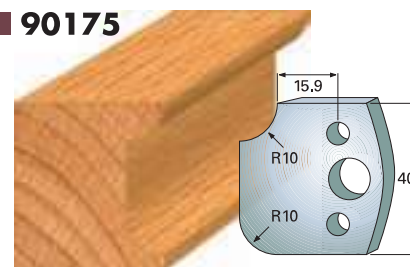
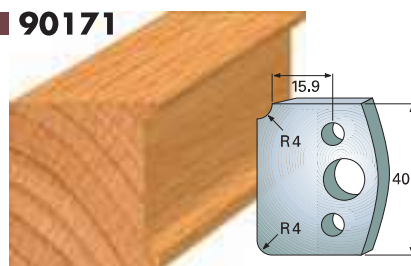
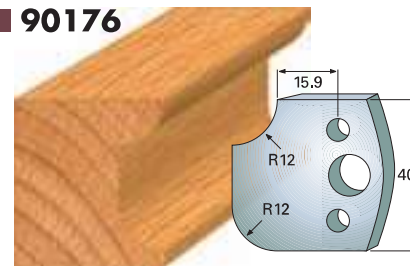
**90174****90170****90175****90171****90176**

## Profilstål i verktygsstål 50 x 4 mm

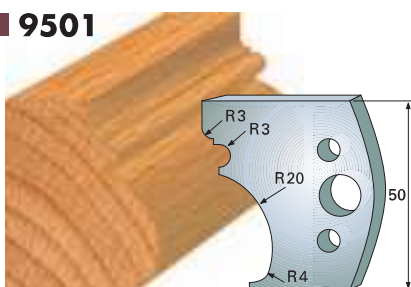
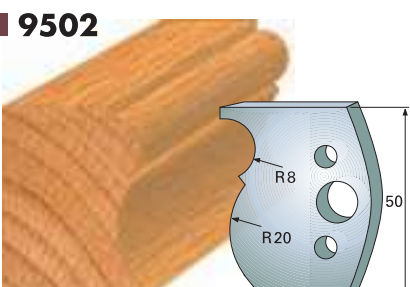
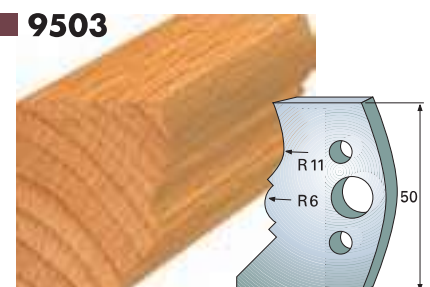
**9501****9502****9503**



■ 9504

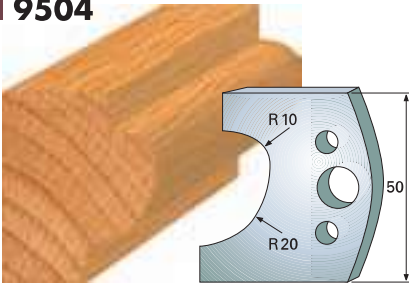

■ 9510

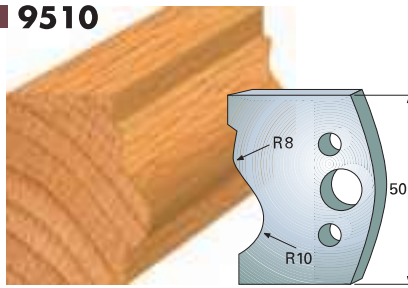

■ 9516

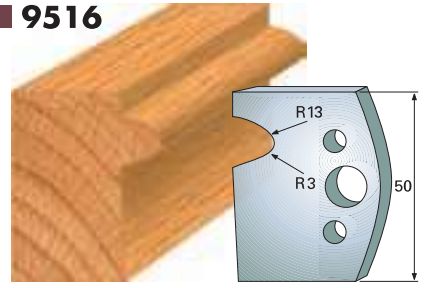

■ 9505

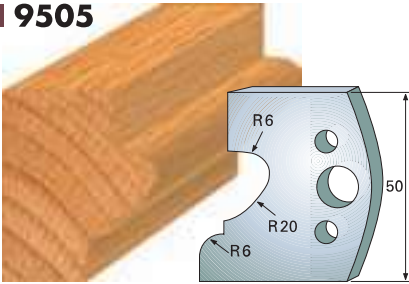

■ 9511

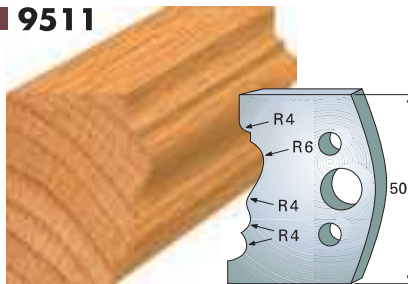

■ 9517

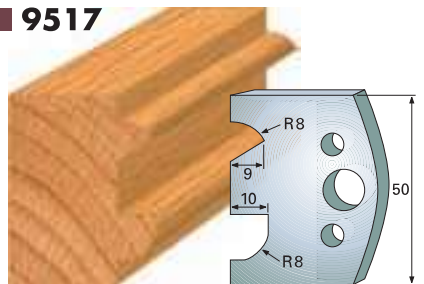

■ 9506

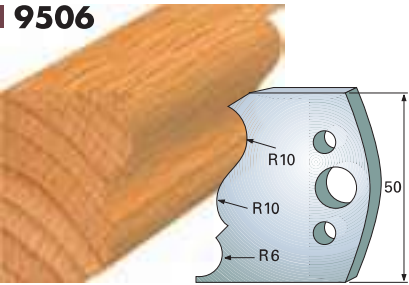

■ 9512

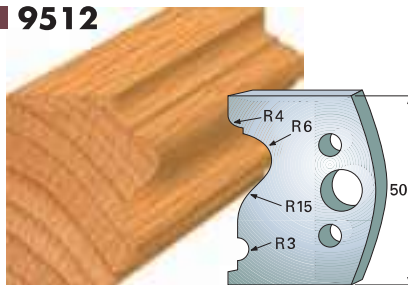

■ 9518

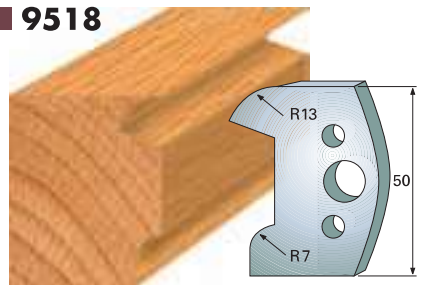

■ 9507

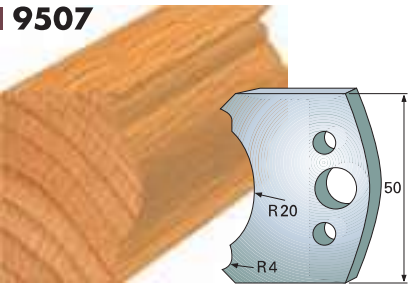

■ 9513

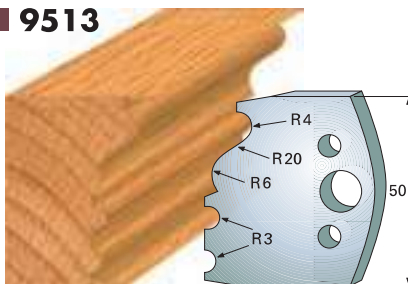

■ 9519

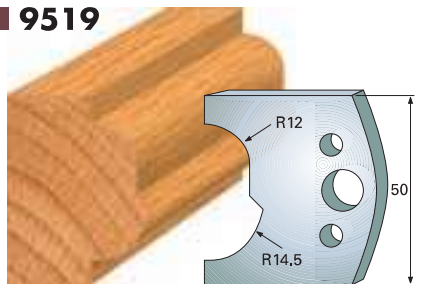

■ 9508

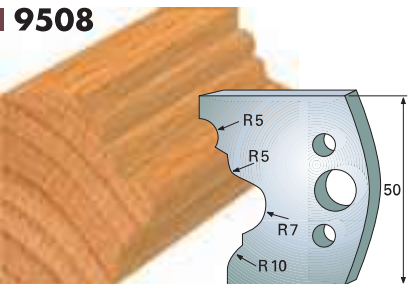

■ 9514

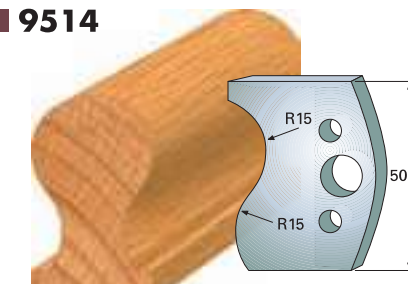

■ 9509

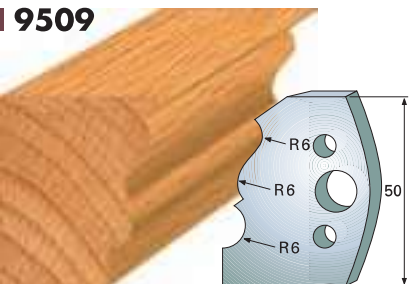

■ 9515

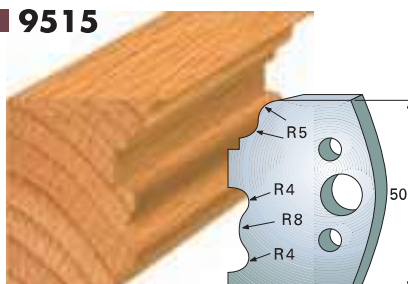

Hittar du inte profilen som passar dig, se specialtillverkning på sidan 135.

# Profilstål i verktygsstål 50 x 5,5 mm

■ 95200

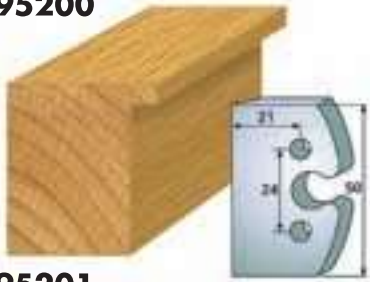

■ 95207

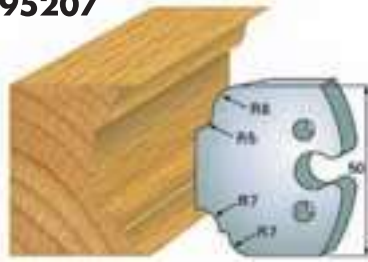

■ 95214



■ 95201

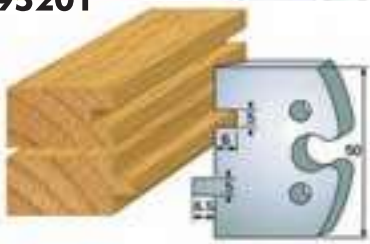

■ 95208



■ 95215



■ 95202

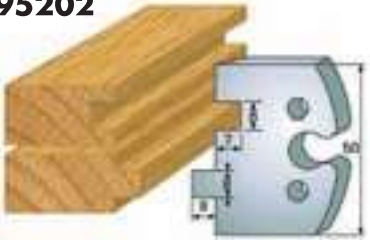

■ 95209

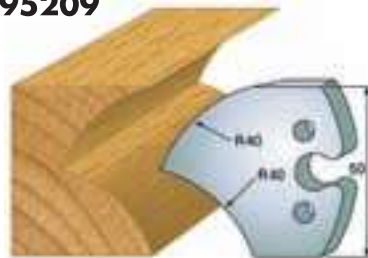

■ 95216



■ 95203



■ 95210

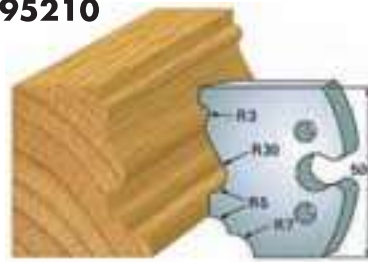

■ 95217



■ 95204



■ 95211

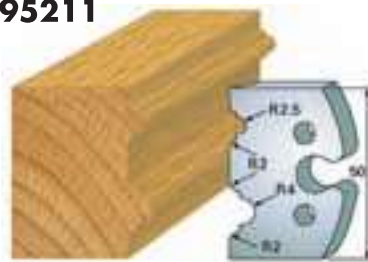

■ 95218

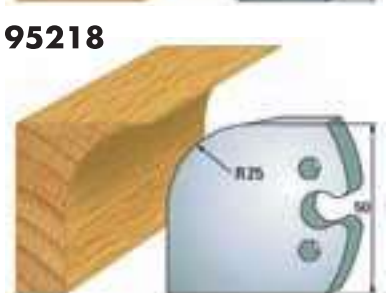

■ 95205

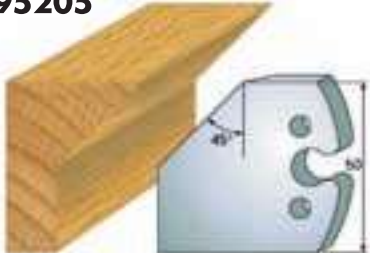

■ 95212



■ 95219



■ 95206



■ 95213



■ 95220



■ 95221



■ 95226



■ 95231

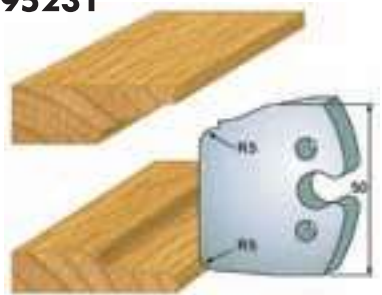

■ 95222



■ 95227



■ 95232



■ 95223



■ 95228



■ 95233



■ 95224



■ 95229



■ 95225



■ 95230



<b>Planstål, 510 mm</b>	
Överkutter MP360, MP365	
1 par	HSS-510

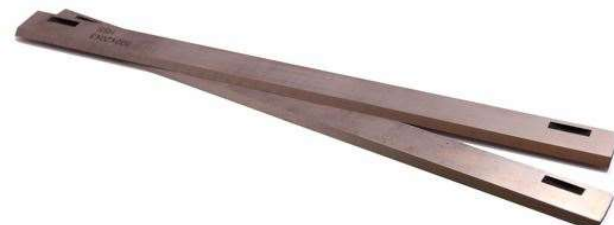

<b>Planstål, 410 mm</b>	
Överkutter MP260, underkutter MP360, MP365	
1 par	HSS-RPH410



<b>Planstål, 300 mm</b>	
Underkutter MP260	
1 par	HSS-PH300



■ 9500-20HSS

<b>Planstål, 50 mm</b>	
Planstål, Sidokutter	
1 par	9500-20HSS

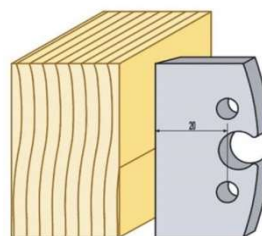

<b>Kutterkil KIL-038</b>	
Kutterkil, Över, underkutter MP260, Underkutter MP280, MP360	
1 par	KIL-038

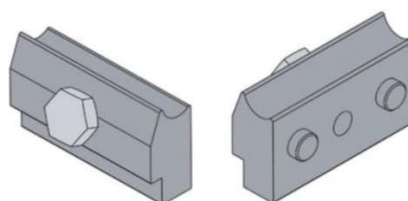

<b>Kutterkil KIL360-048</b>	
Kutterkil, Överkutter MP280, MP360	
1 par	KIL360-048



<b>Kutterkil STÄLLKIL-038</b>	
Kutterkil, Över, underkutter MP260, Underkutter MP280, MP360	
1 par	STÄLLKIL-038



<b>Kutterkil STÄLLKIL360-048</b>	
Kutterkil, Överkutter MP280, MP360	
1 par	STÄLLKIL360-048



<b>Kutter</b>	<b>TB90-92 STÅL Z2</b>		
Kutter	Sidokutter, D88 b40 d30 Z2	2 stål	
1 st	TB90-92 Z2 Stål		



<b>Kutter</b>	<b>TB90-92 STÅL Z4</b>		
Kutter	Sidokutter, D88 b40 d30 Z4	4 stål	
1 st	TB90-92 Z4 Stål		

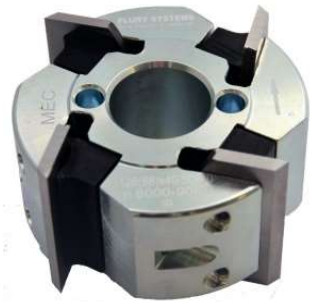

## Priser på hyvelstål

HSS-510	833:-
HSS-RPH410	1023:-
HSS-PH300	932:-
9500-20HSS	819:-
KIL-038	477:-
STÄLLKIL-038	537:-
TIMKIL-038	512:-
KIL360-048	1029:-
STÄLLKIL360-048	1700:-
94000HSS	635:-
95000HSS	819:-
96000HSS	998:-
98000HSS	1449:-
91000HSS	1449:-
91300HSS	1846:-
TB90-92 Z2 Stål Kutter	1661:-
TB90-92 Z4 Stål Kutter	2644:-

2024-11-01

Moms tillkommer på alla priser.



**Wood-Mizer**  
from forest to final form

**MEKWOOD AB**

Magasinsgatan 29, 812 31 Storvik - 0290-515 65, 070-679 79 65  
info@mekwood.se - www.mekwood.se - www.woodmizer.se