

HYVELSTÅL och Tillbehör



Wood-Mizer®

from forest to final form

MEKWOOD AB

Magasinsgatan 29, 812 31 Storvik - 0290-515 65, 070-679 79 65
info@mekwood.se - www.mekwood.se - www.woodmizer.se

REGEL & TRALL

■ Rak

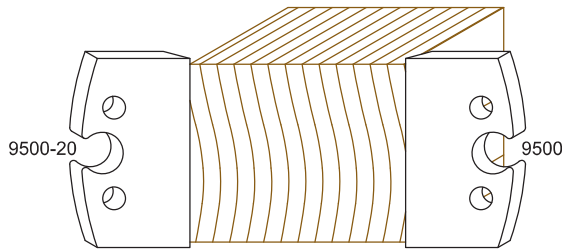

■ Avrundning, enkel

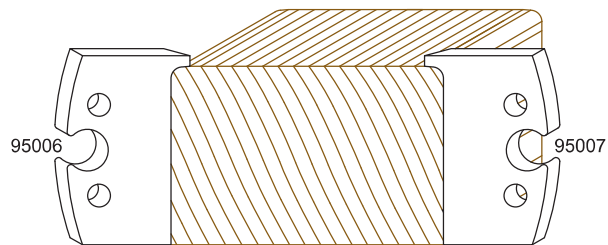

■ Avrundning, dubbel, 22 mm

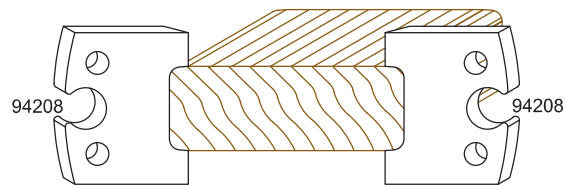

■ Avrundning, dubbel, 25 mm

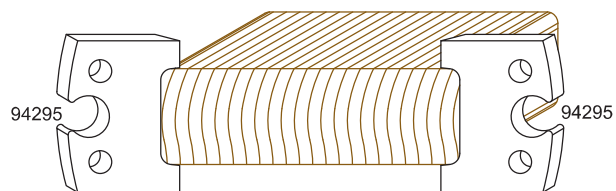

■ Avrundning, dubbel, 28 mm

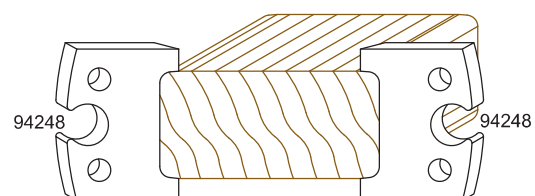

■ Avrundning, dubbel, 45 mm

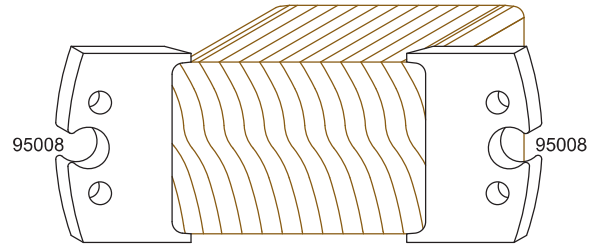

■ Avrundning, dubbel, 48 mm

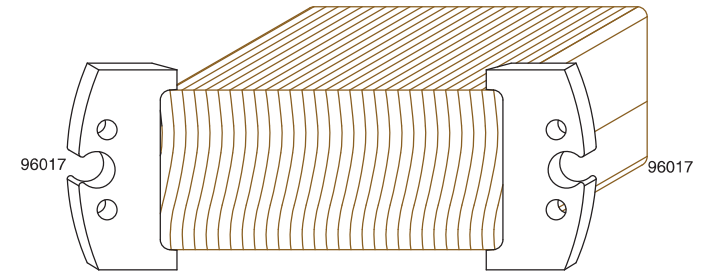

■ Grepp profil 1

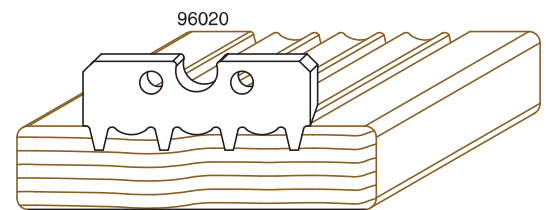

■ Grepp profil 2

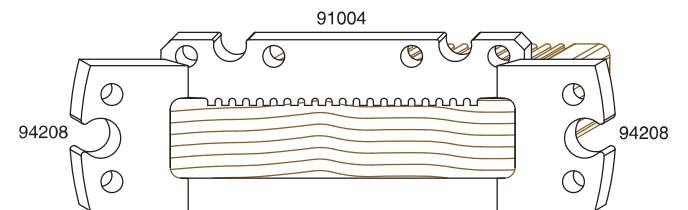

■ Grepp profil 3

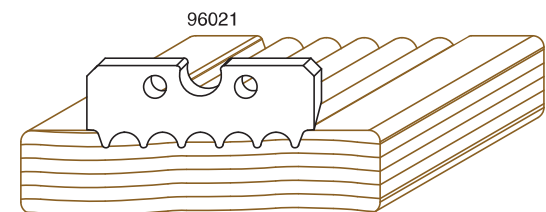

NOT & SPONT

■ Not & Spont, 4 mm (tät 0,1 mm)

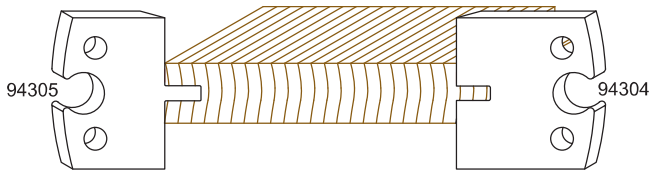

■ Not & Spont, 4,5 mm (tät 0,1 mm)

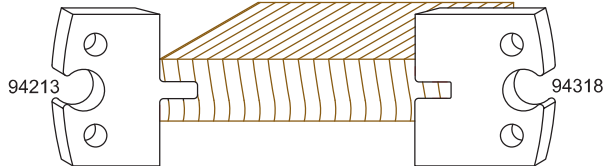

■ Not & Spont, 6 mm (tät 0,1 mm)

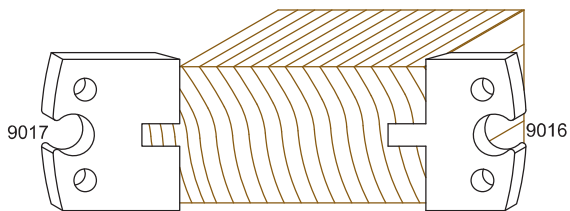

■ Not & Spont, 6 mm (Råspont)

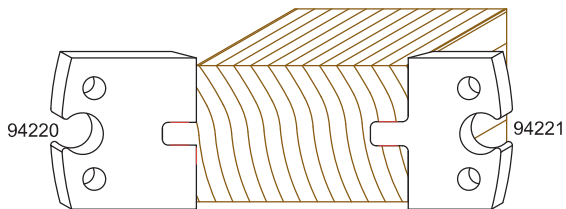

■ Not & Spont, 8 mm (Golvspont)

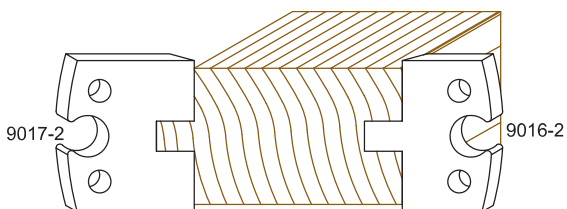

■ Not & Spont, 10 mm (Golvspont)

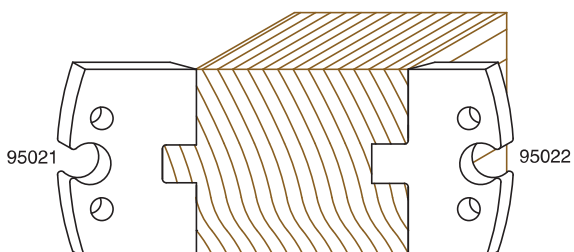

■ Not & Spont, 10 mm (tät)

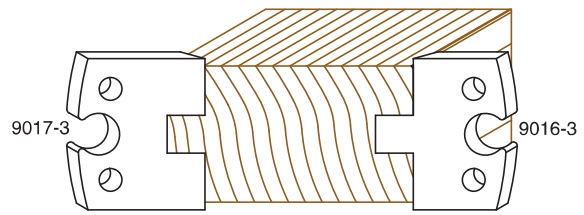

■ Not & Spont (Badkar)

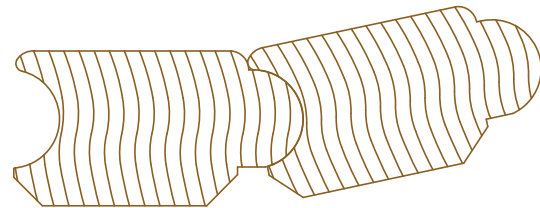
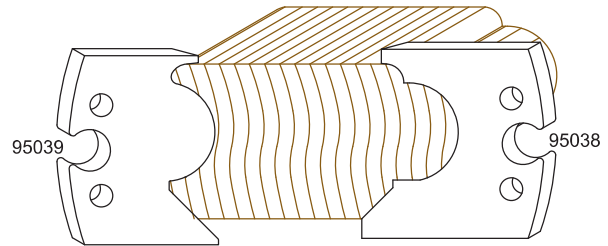

■ Not & Spont (Badkar)

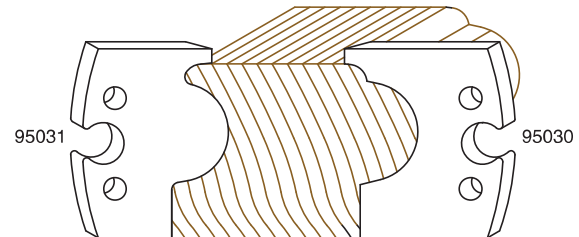

■ Not & Spont (Golvspont med spikfas)

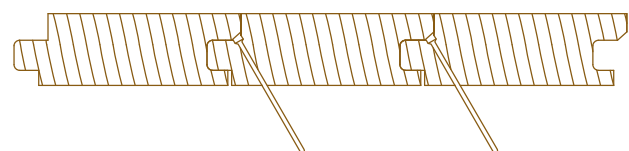
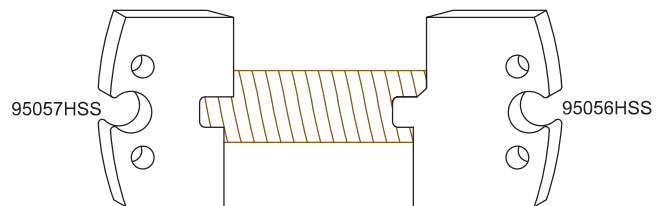

■ **Not & Spont** (Golvspont med spikfas)

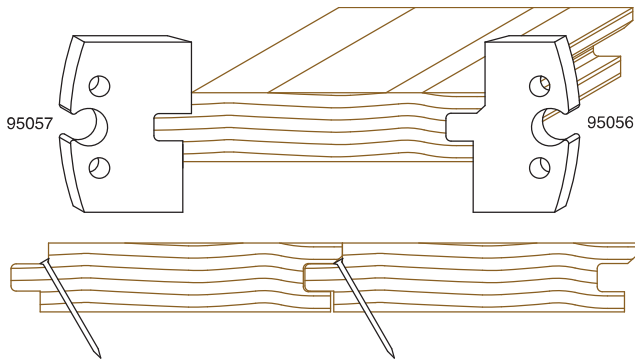

■ **Not & Spont** (Golvspont)

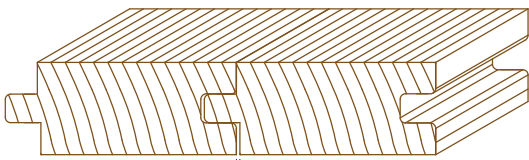
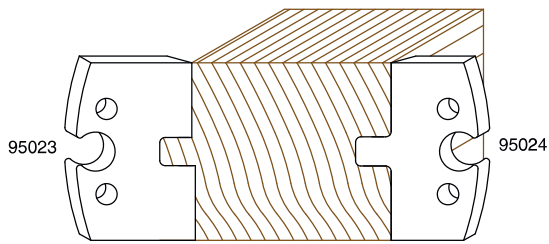

■ **Not & Spont** (Fasad golvprofil med spikfas)

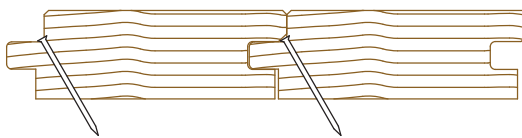
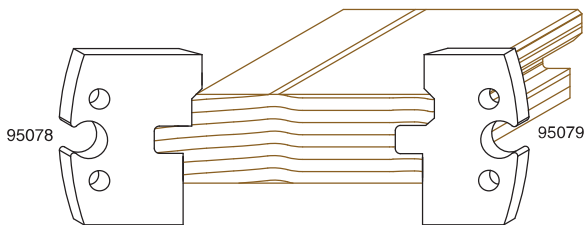

■ **Not & Spont** (Kantotstål)

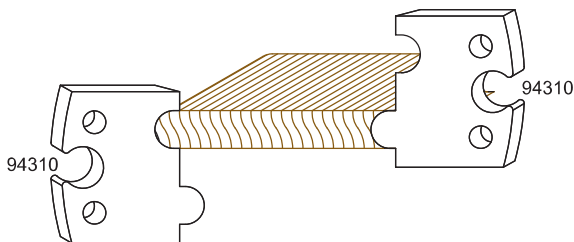

■ **Not & Spont** (Friggebod)

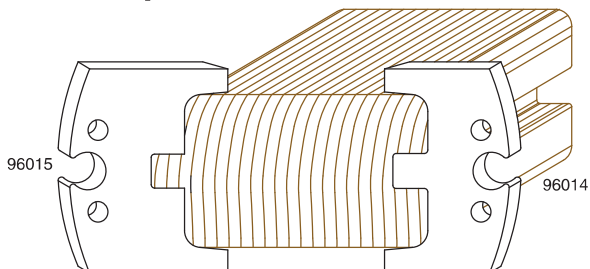

■ **Not & Spont** (Friggebod usa)

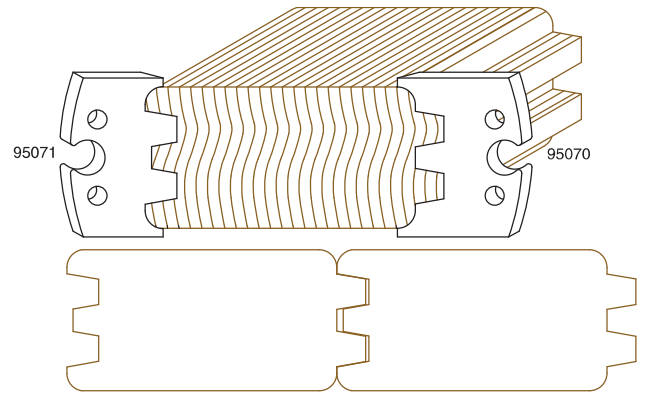

UTOMHUSPANELER

■ **Faspanel**

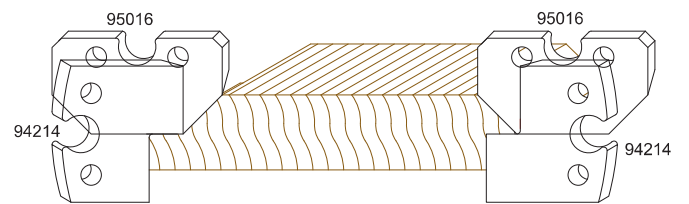

■ **Faspanel, not 3 mm**

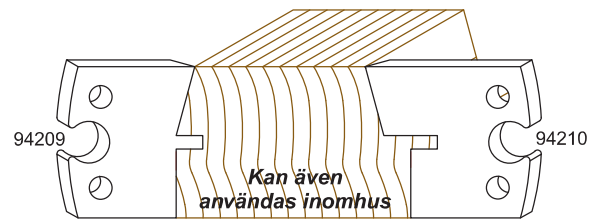

■ **Faspanel, not 5 mm**

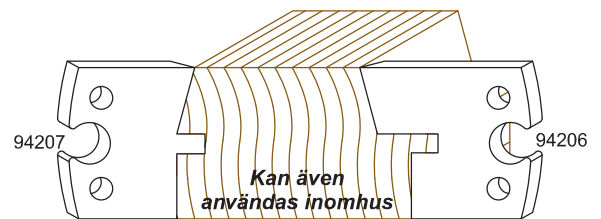

■ **Avrundad panel**

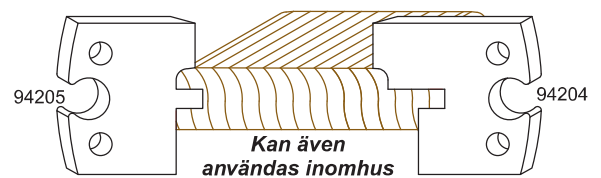

■ **Hålkälspanel**

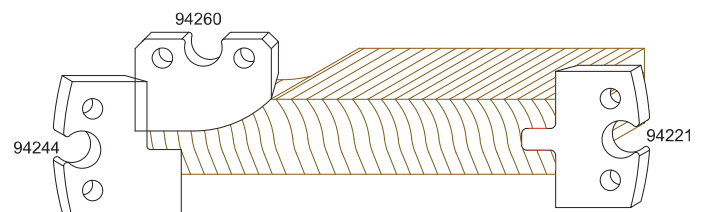

■ Stockpanel

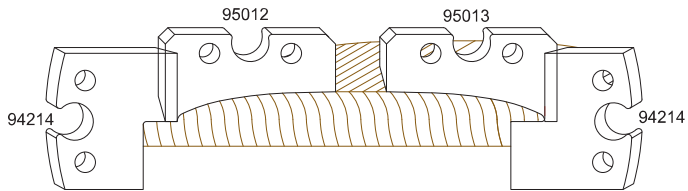

■ Norgepanel, svanhals

Stående not- och spontpanel med sågad framsida. 4-skärig kutter behövs.

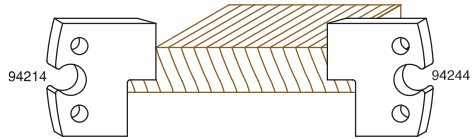
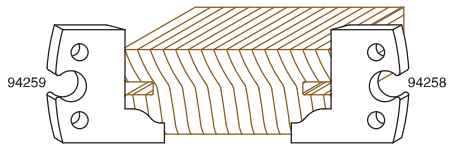
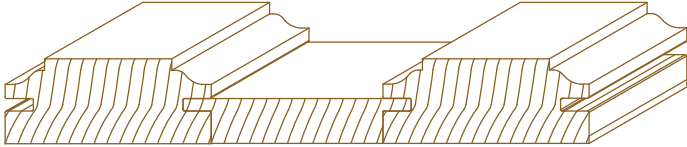

■ Norgepanel, hälkäl

Stående not- och spontpanel med sågad framsida. 4-skärig kutter behövs.

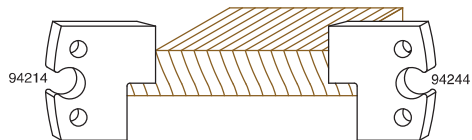
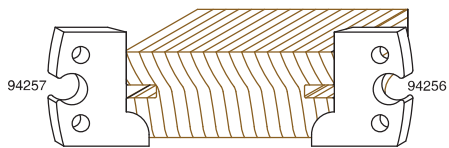
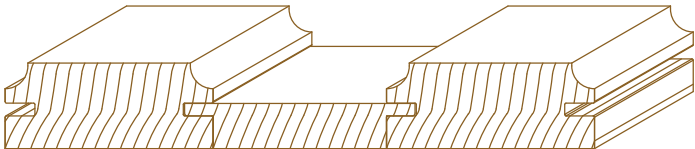

■ Stockhuspanel, 45 mm

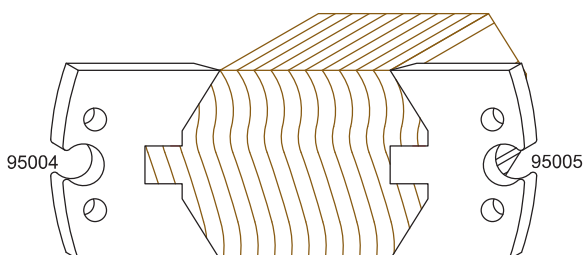

■ Stockhuspanel, 70 mm

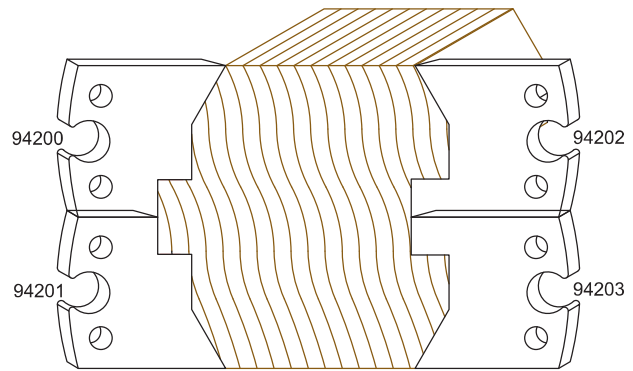

■ Fjällpanel

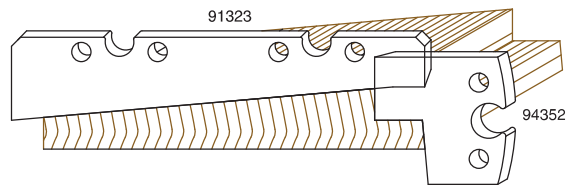

INOMHUSPANELER

■ Morapanel

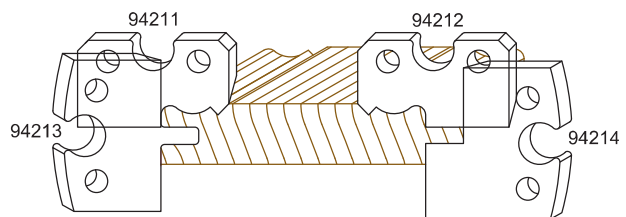

■ Pärlspont

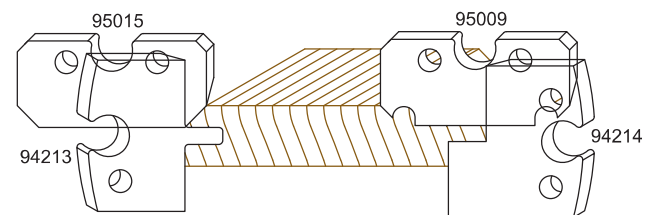

■ Pärlspont med mittprofil

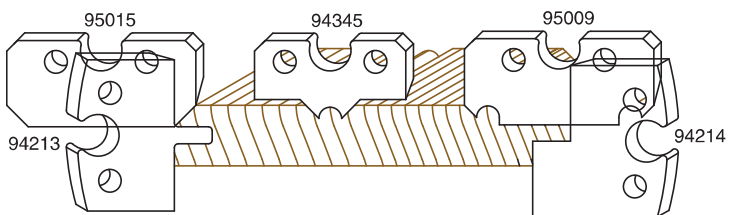

■ Stor pärlspont

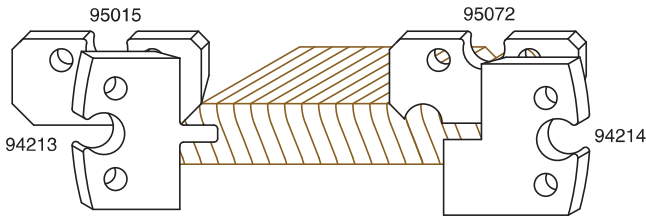

■ Avrundad panel

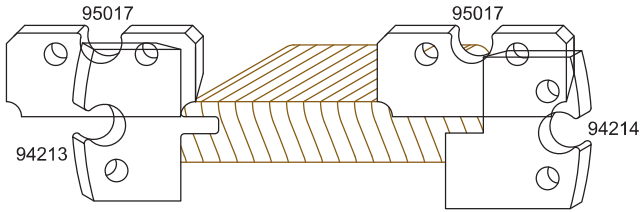

■ Faspanel

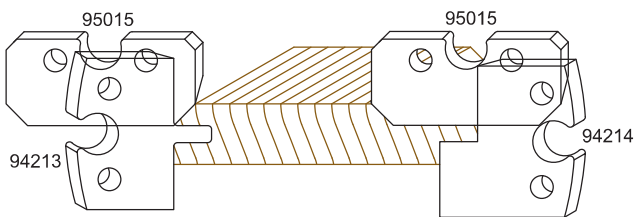

■ 45° Faspanel

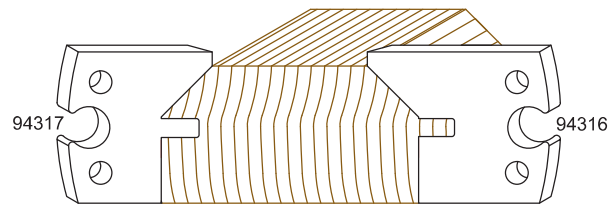

■ Dubbel 45° Faspanel

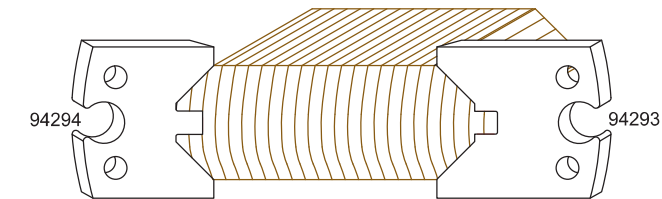

■ Faspanel med mittprofil

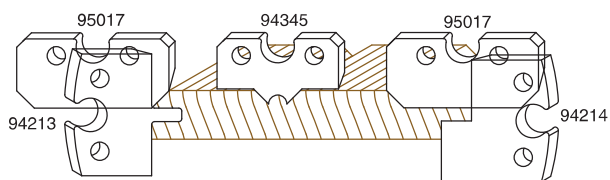

■ Faspanel med mittprofil

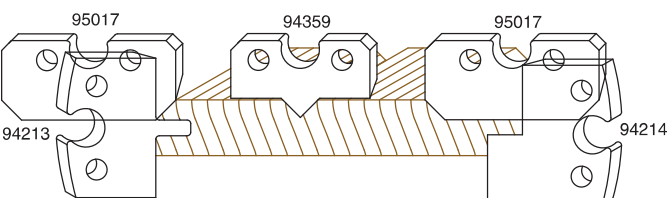

■ Faspanel

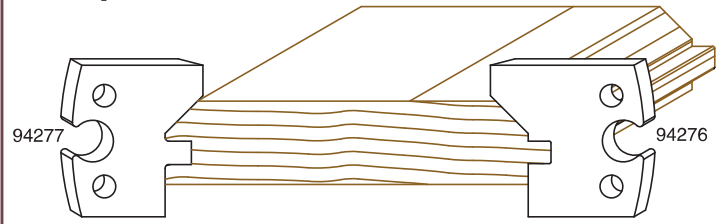

■ Enkel takpanel

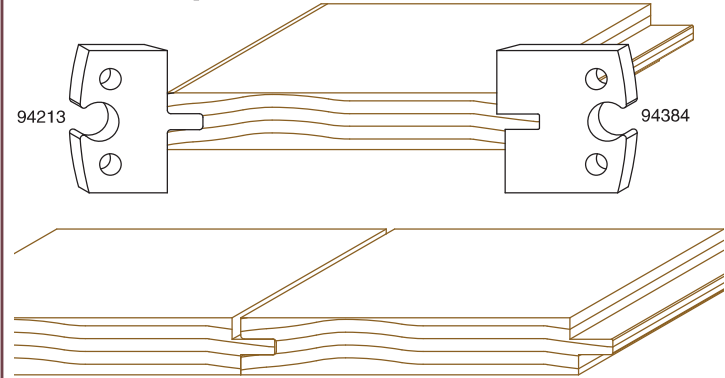

LOCKPANEL

■ Hattlock

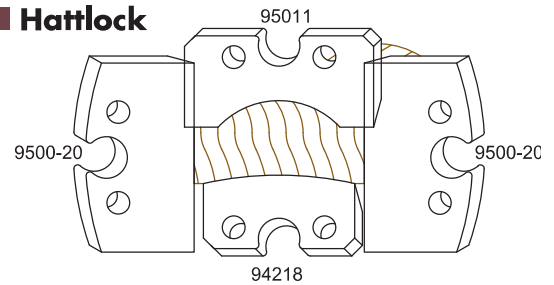

■ Faslock

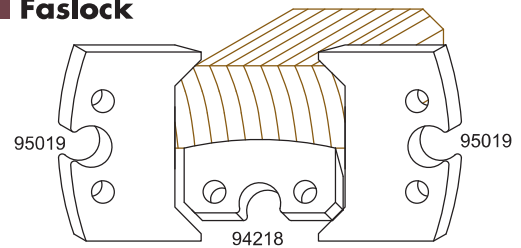

■ Dekorlock

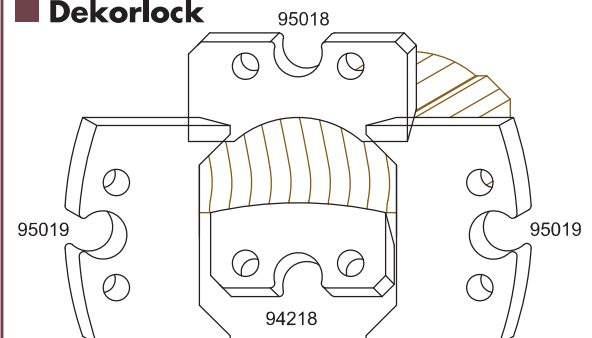

■ Dekorlock

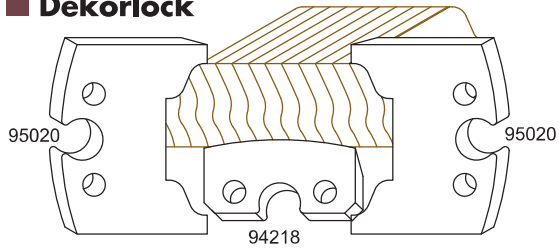

■ Dekorlock

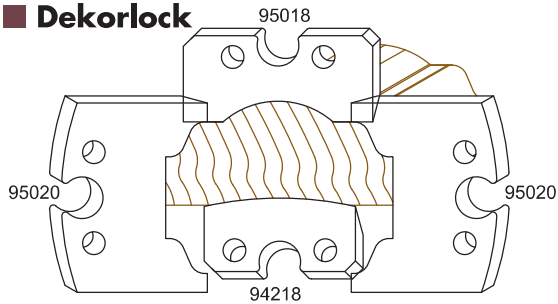

BRÖSTLIST

■ Rundad

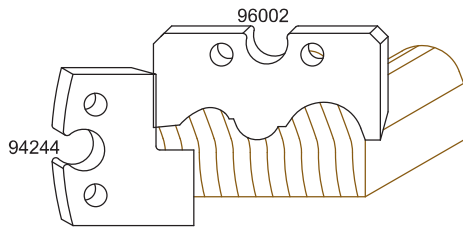

■ Profil

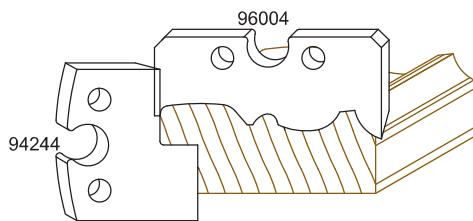

■ Profil

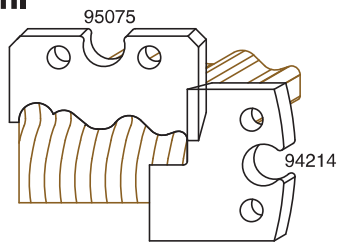

■ Villa Frimodig

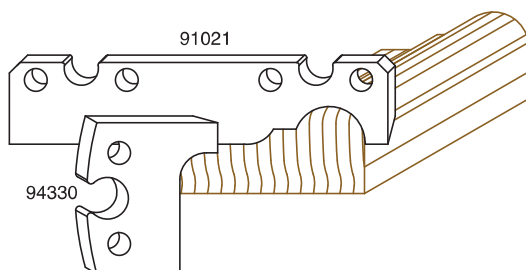

SPÄRNING & URFRÄSNING

■ Spärning av foder

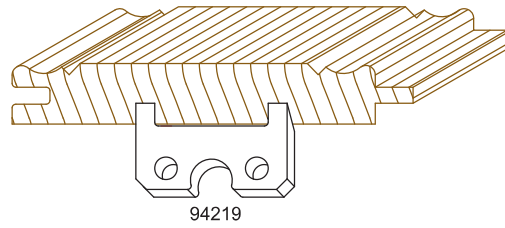

■ Urfräsning av foder

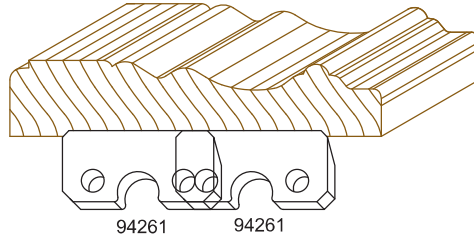

■ Urfräsning av golvlist

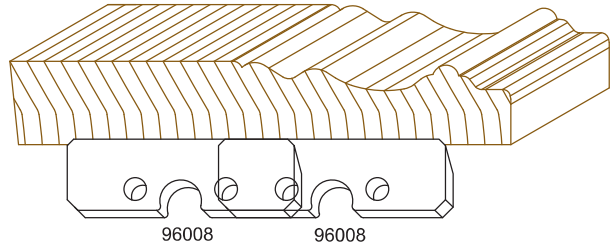

GOLVLIST

■ Smyglist

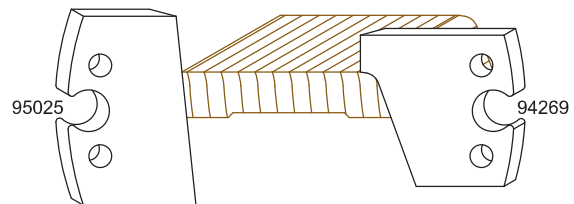

■ Stocklist

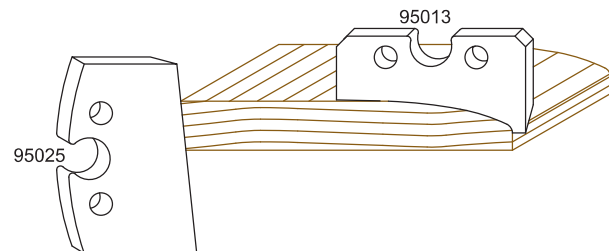

■ Svanhalslist

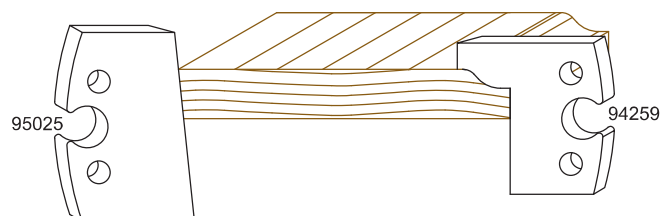

■ Kvartstavslist

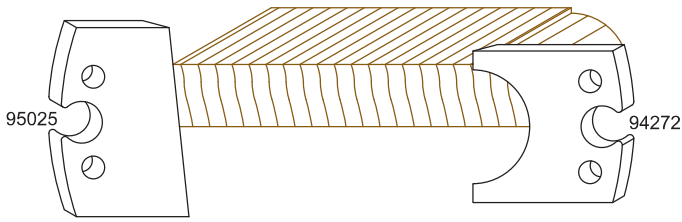

■ Allmogelist

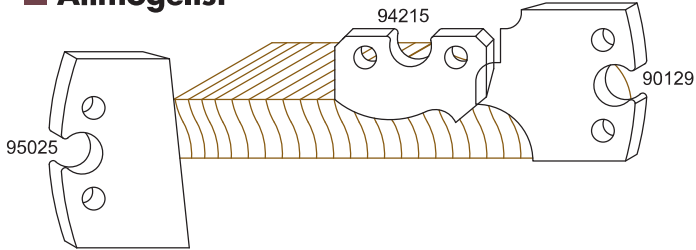

■ Hagalist

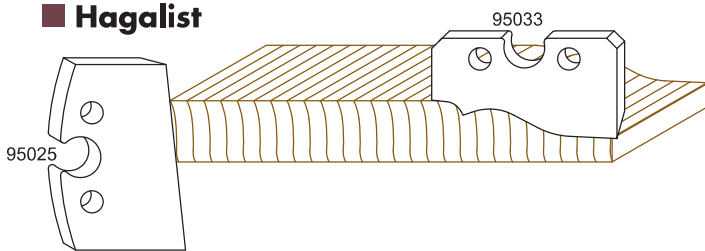

■ Gamlestadsl

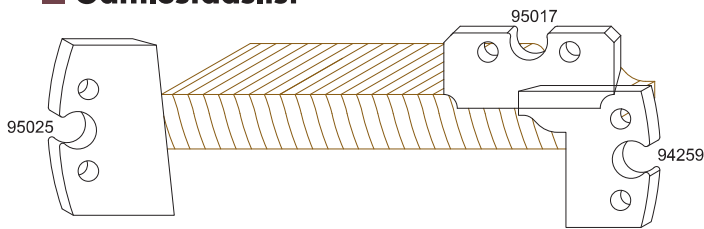

■ Stockholmslist

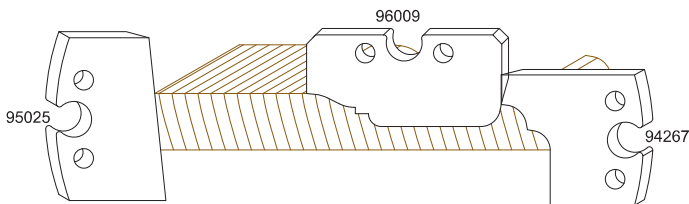

■ Gotlandslist

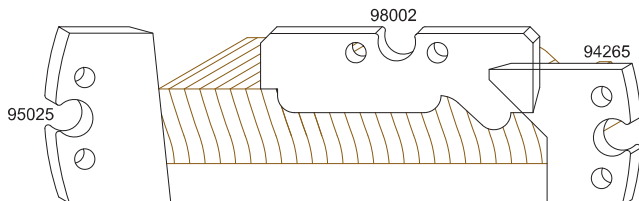

■ Hallandslist

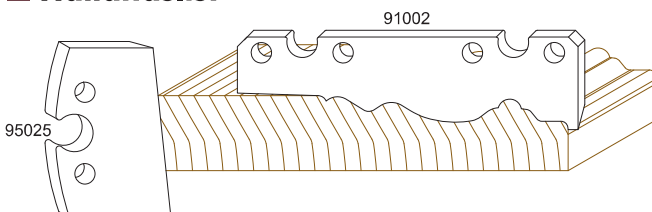

■ Backalist

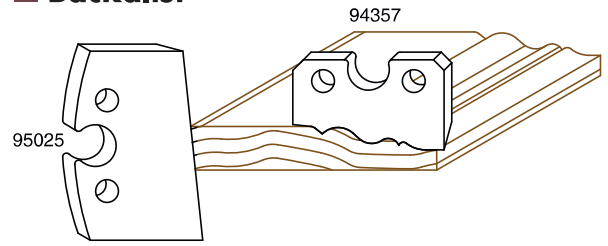

■ Utbylist

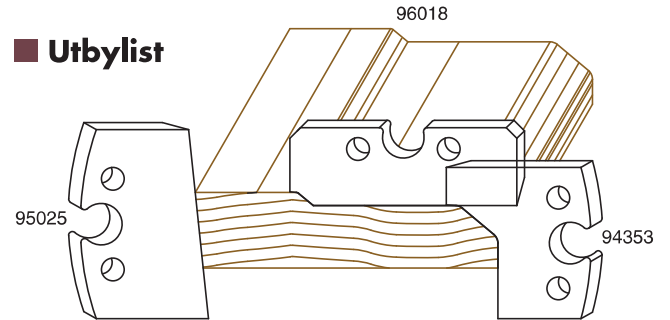

■ Villa Frimodig

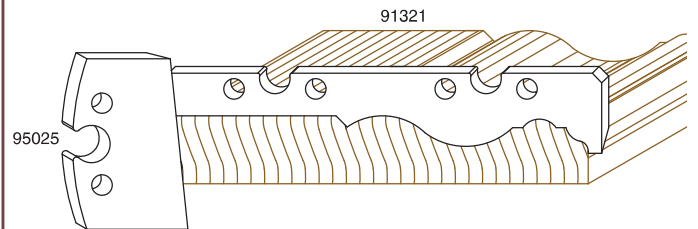

DÖRRPROFIL

■ Dörrprofil 1

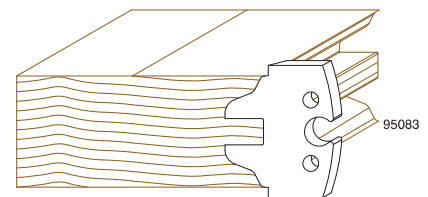
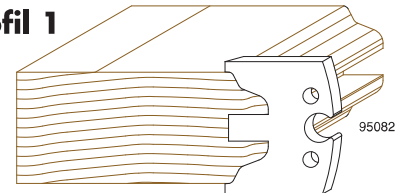

■ Dörrprofil 2

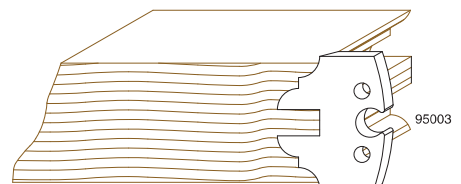
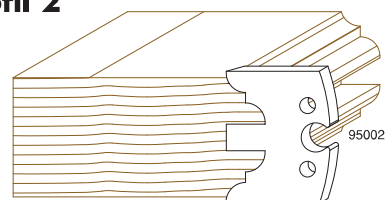

HÖRNBLOSS

Förbindning

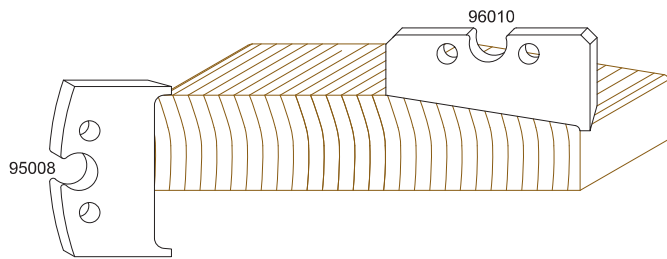

En dekorativ förbindningskloss för att få snygga avslutningar på olika lister. Mycket bra vid kraftiga profiler på listerna.

Dekorfoder, 95 mm

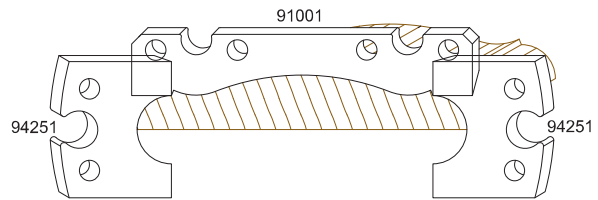

Gamlestads

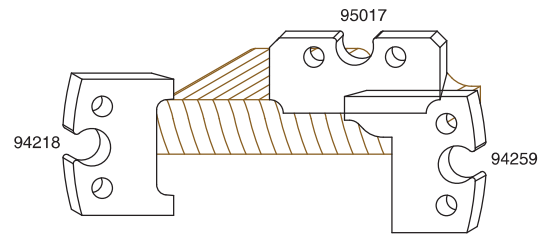

Gotland

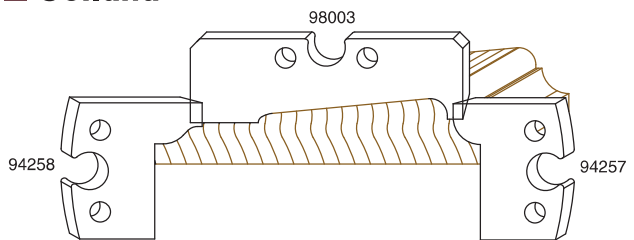

Hagafoder

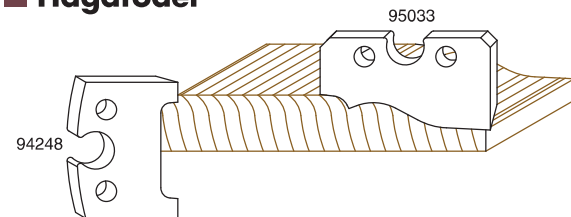

Halland

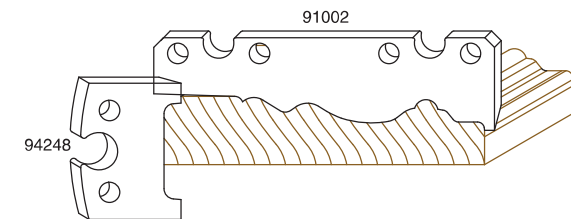

Kvartstav

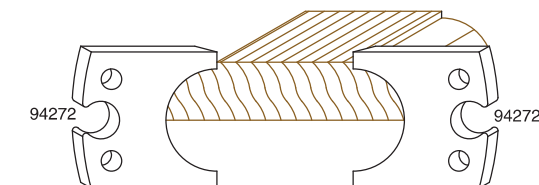

Doortrim

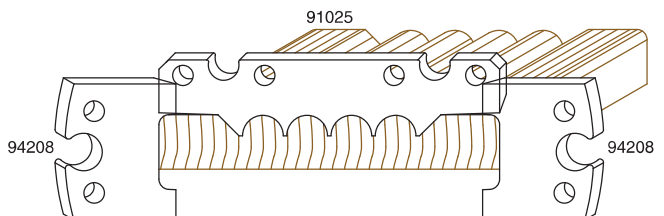

FODER

Allmogefoder

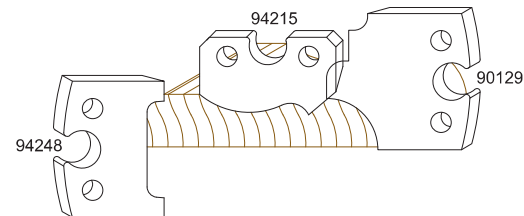

Amerikafoder, 57mm

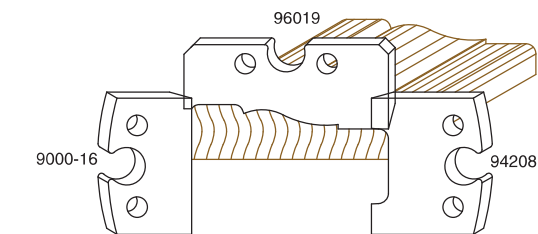

Backafoder

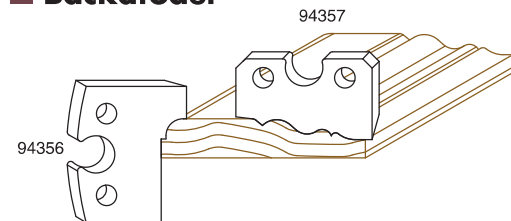

Dekorfoder, 70 mm

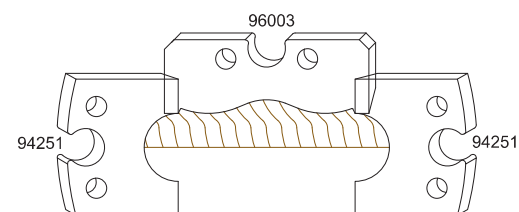

Rundat foder

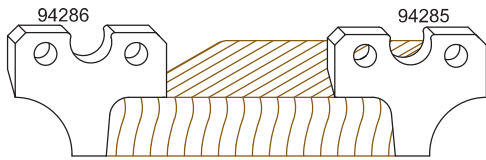

Skiröfoder

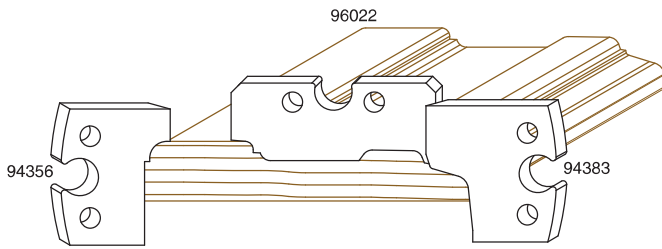

Stockholm

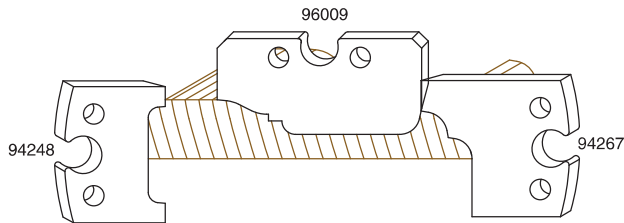

Svanhals

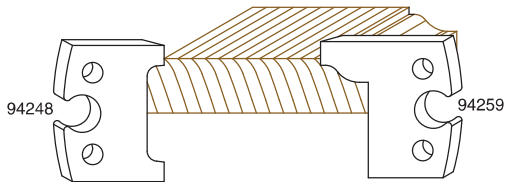

Sätrafoder

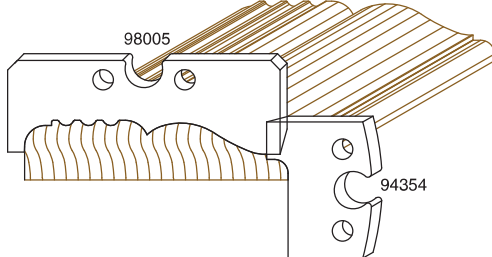

Utbyfoder

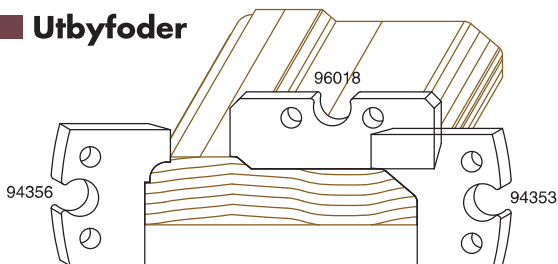

Villa Frimodig

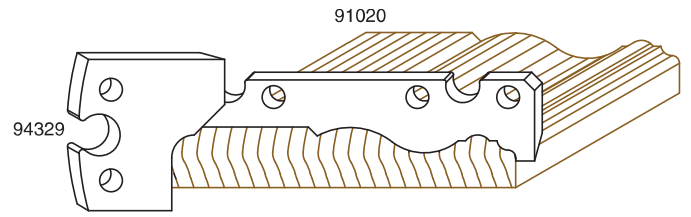

TAKLIST

Skugglist

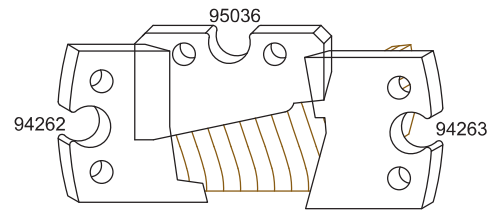

Trappstegslist

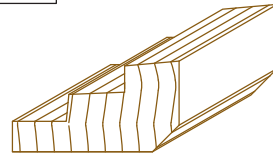
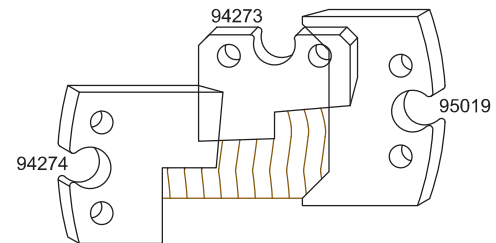

Kvartstavstaklist

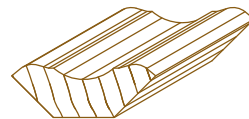
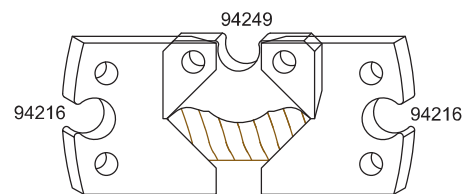

Profiltaklist, 70 mm

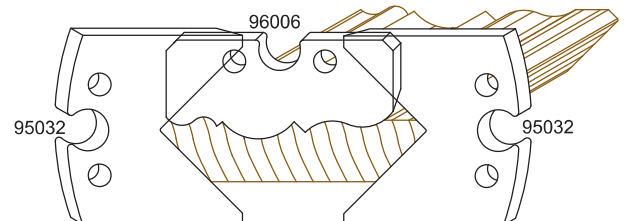

■ Svanhalstaklist, 45 mm

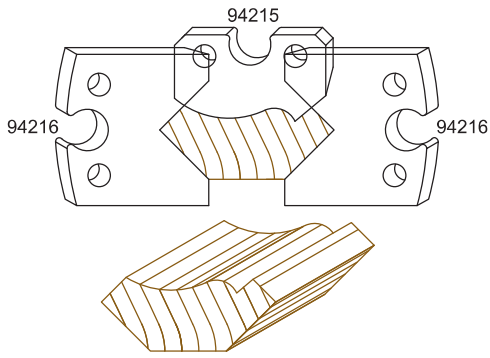

■ Svanhalstaklist, 56 mm

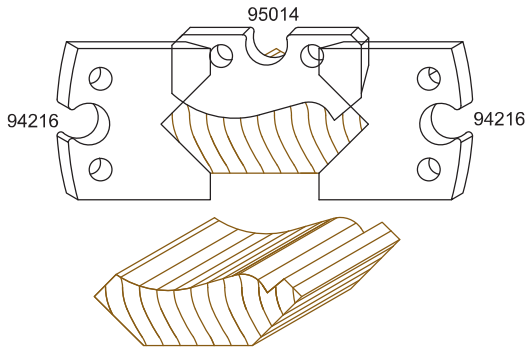

■ Svanhalstaklist, 68 mm

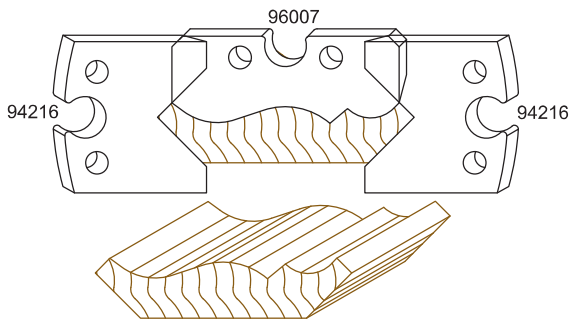

■ Svanhalstaklist, 80 mm

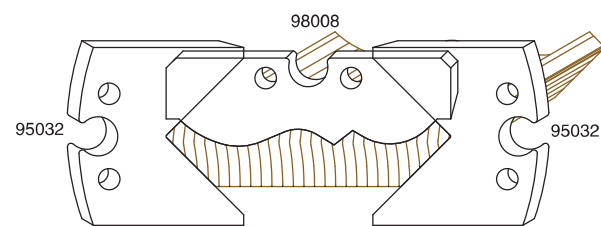

■ Svanhalstaklist, 95 mm

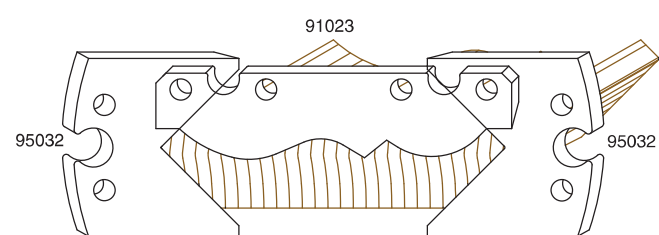

■ Svanhalstaklist, 120 mm

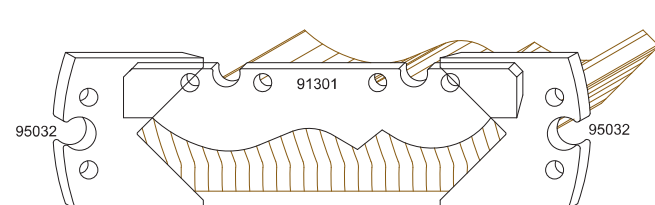

■ Svanhalstaklist usa, 80 mm

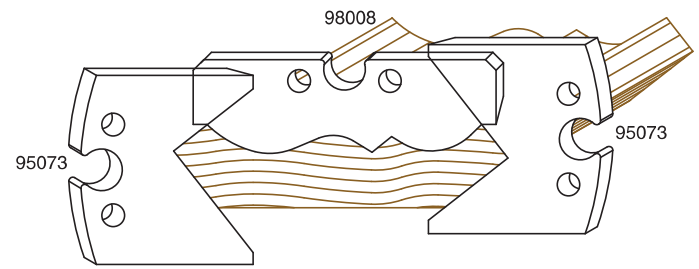

■ Hålkälstaklist, 45 mm

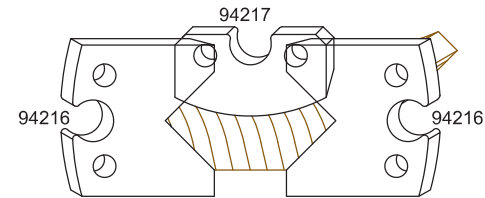

■ Hålkälstaklist, 60 mm

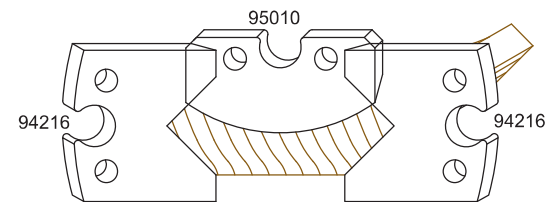

■ Hålkälstaklist, 70 mm

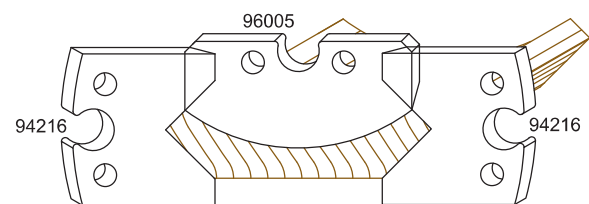

■ Hålkälstaklist, 95 mm

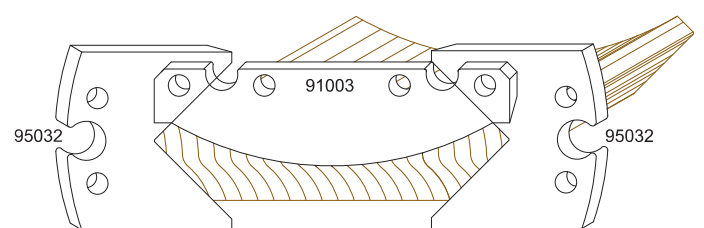

■ Stukaturlist

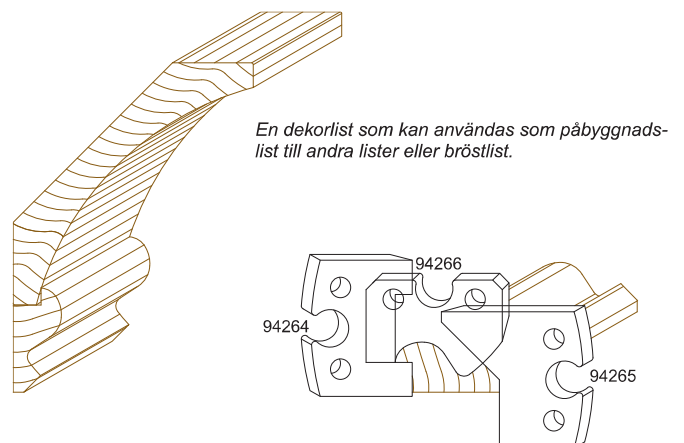

■ **Backataklist**

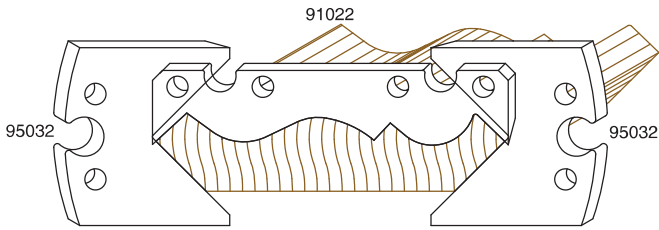

■ **Utbylist**

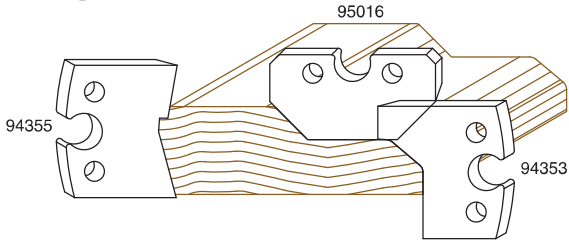

■ **Villa Frimodig**

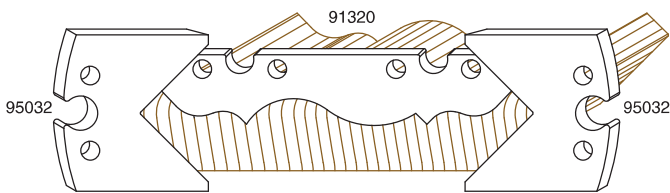

KVARTSSTAV

■ **Kvartsstav, 15 mm**

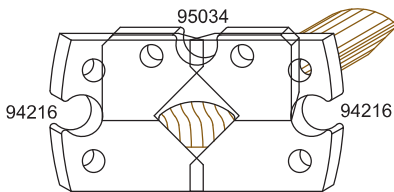

■ **Kvartsstav, 21 mm**

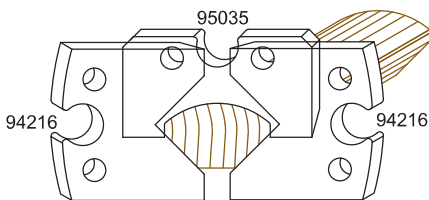

GARDINSTÅNG

■ **Diameter 30 mm**

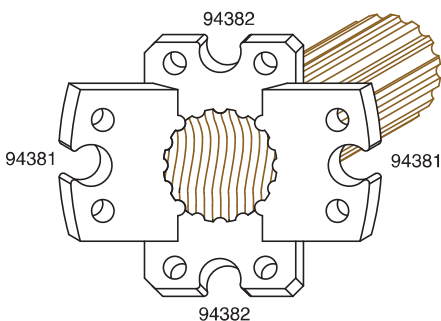

RUNDSTAV

■ **Rundstav, 21 mm**

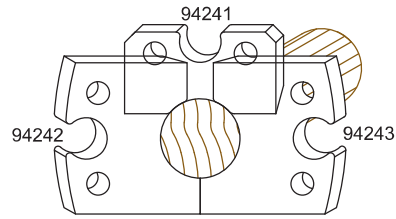

■ **Rundstav, 24 mm**

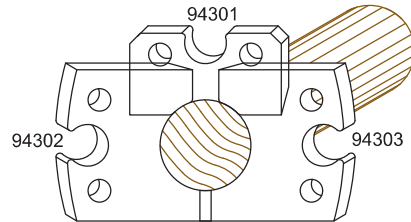

■ **Rundstav, 27 mm**

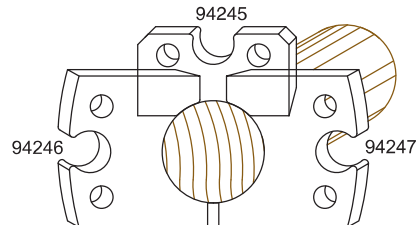

■ **Rundstav, 40 mm**

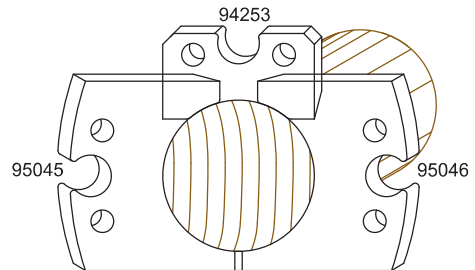

FASSTÅL

■ **Dubbel 45° fasning**

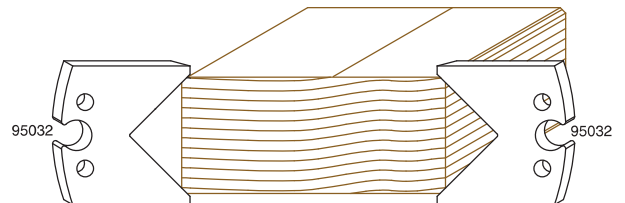

■ **Enkel 45° fasning**

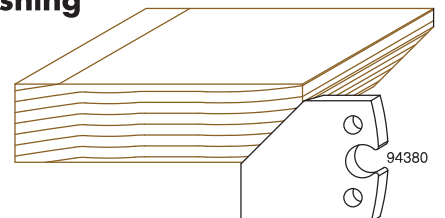

UNDERBRÄDA TILL FÖNSTER

■ Profil

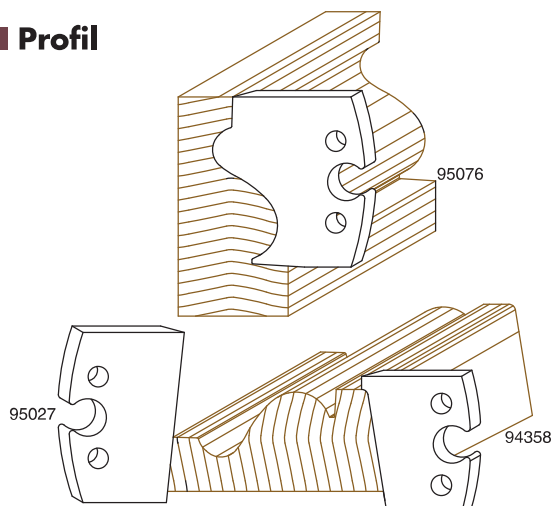

■ Villa Frimodig

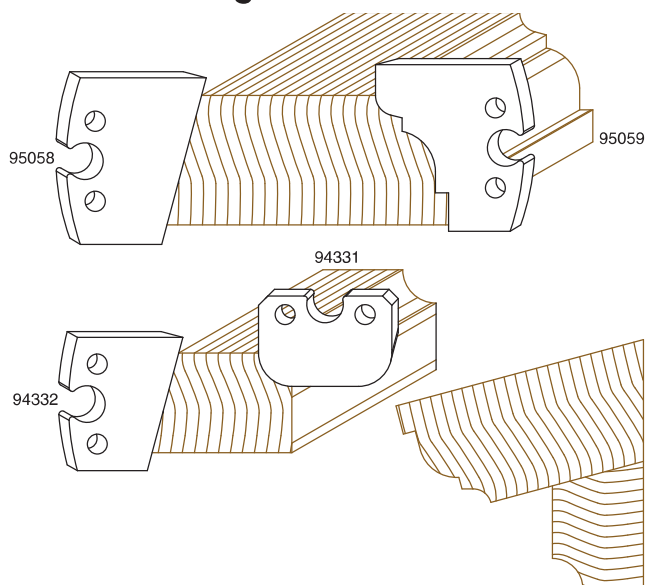

FALSSTÅL

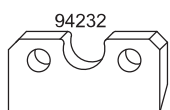

94232

94232HSS

Detta stål ger 2 mm falsdjup

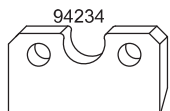

94234

94234HSS

Detta stål ger 4 mm falsdjup

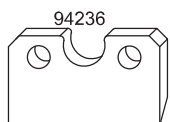

94236

94236HSS

Detta stål ger 6 mm falsdjup

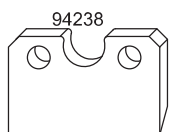

94238

94238HSS

Detta stål ger 8 mm falsdjup

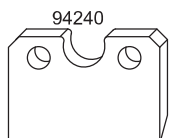

94240

94240HSS

Detta stål ger 10 mm falsdjup

STÅL TILL SOLOHYVELN

I Solohyveln kan i vissa fall mer än 10 mm utstick användas i överkuttern, vilket gör att dessa stål enbart passar till denna maskinen. Ett sådant stål är 95028HSS.

■ Rundat foder

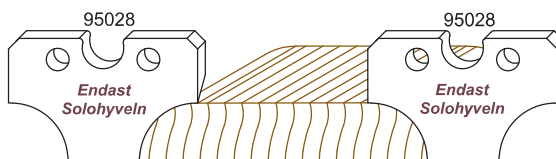

■ Rundad golvlist

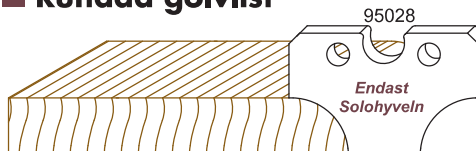

■ Allmogefoder

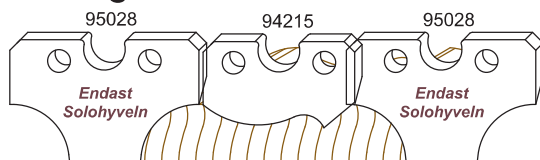

■ Allmogegolvlist

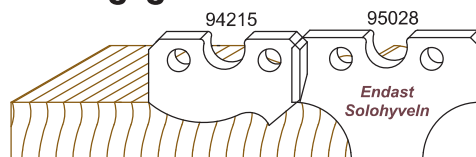

■ Faspanel

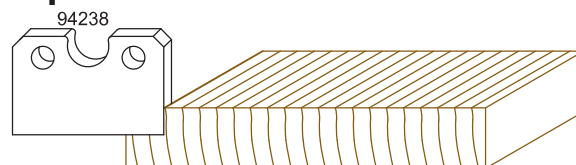

Starta med att hyvla en fals på baksidan.

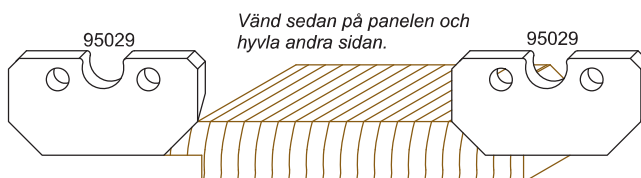

Vänd sedan på panelen och hyvla andra sidan.

■ Stål för trallvirke

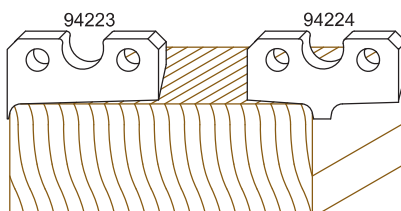

Profilstål i HSS 40 x 4 mm

40 mm

■ 94200HSS

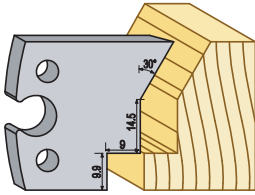

■ 94201HSS

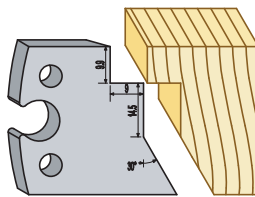

■ 94202HSS

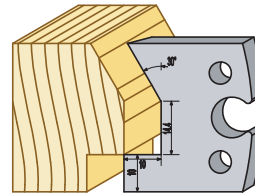

■ 94203HSS

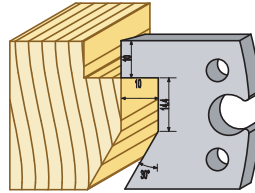

■ 94204HSS

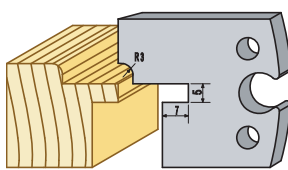

■ 94205HSS

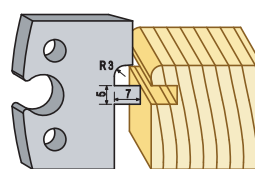

■ 94206HSS

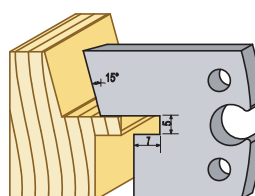

■ 94207HSS

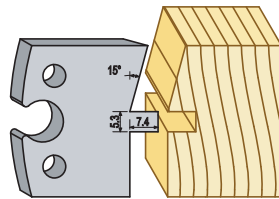

■ 94208HSS

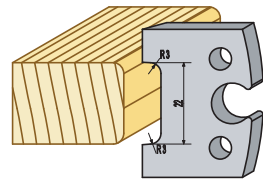

■ 94209HSS

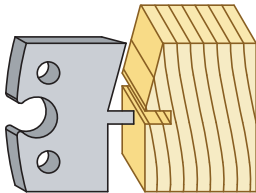

■ 94210HSS

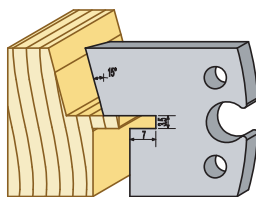

■ 94211HSS

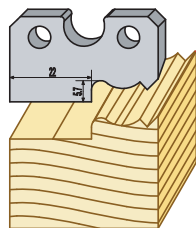

■ 94212HSS

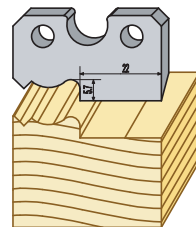

■ 94213HSS

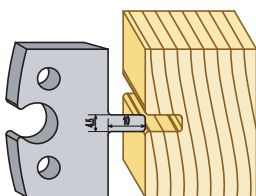

■ 94214HSS

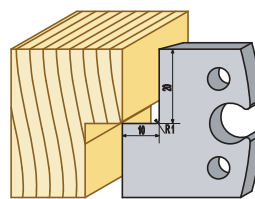

■ 94215HSS

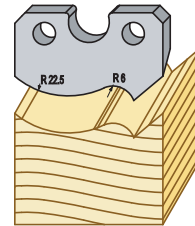

■ 94216HSS

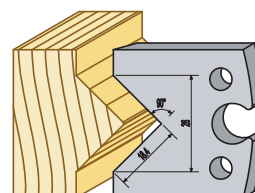

■ 94217HSS

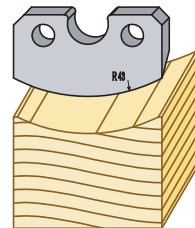

■ 94218HSS

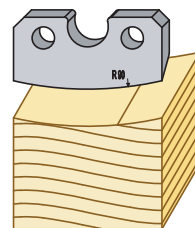

■ 94219HSS

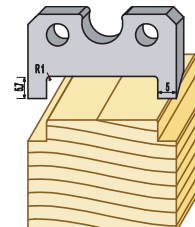

■ 94220HSS

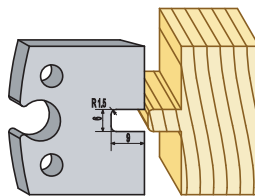

■ 94221HSS

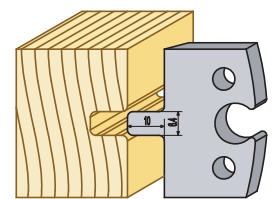

■ 94222HSS

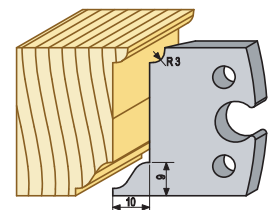

■ 94223HSS

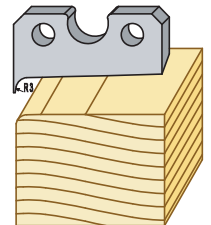

■ 94224HSS

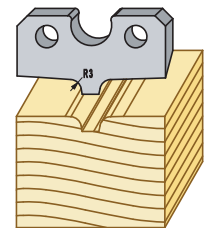

■ 94225HSS

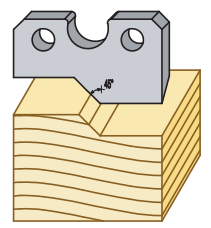

■ 94226HSS

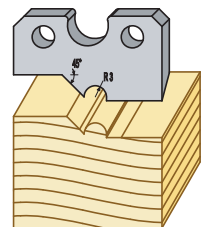

■ 94227HSS

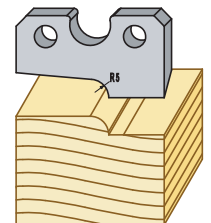

■ 94229HSS

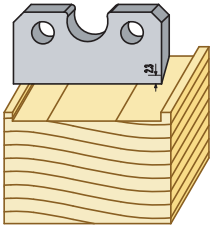

■ 94232HSS

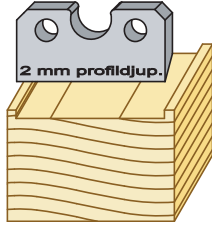

■ 94234HSS

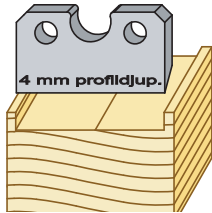

■ 94236HSS

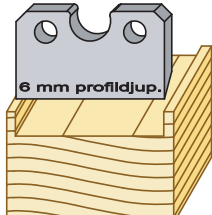

■ 94238HSS

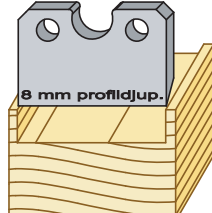

■ 94240HSS

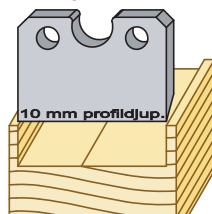

■ 94241HSS

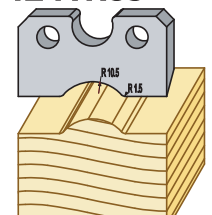

■ 94242HSS

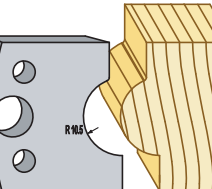

■ 94243HSS

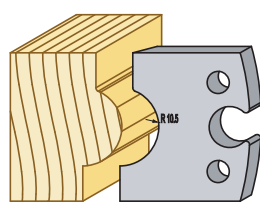

■ 94244HSS

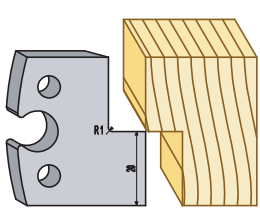

■ 94245HSS

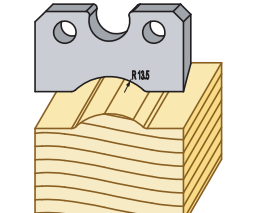

■ 94246HSS

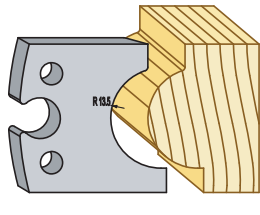

■ 94247HSS

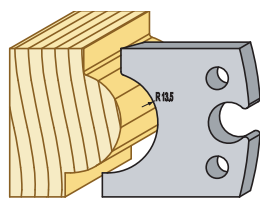

■ 94248HSS

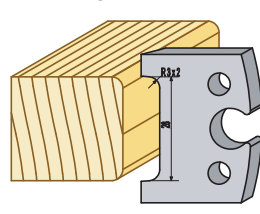

■ 94249HSS

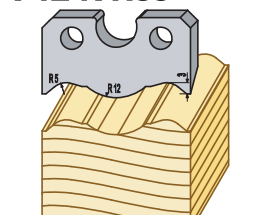

■ 94250HSS

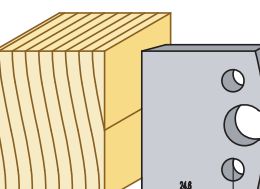

■ 94251HSS

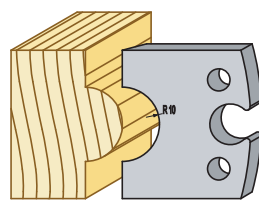

■ 94253HSS

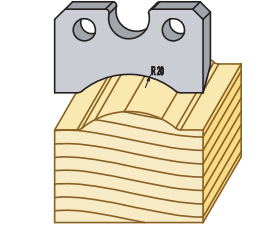

■ 94254HSS

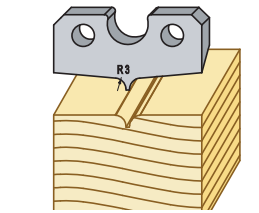

■ 94255HSS

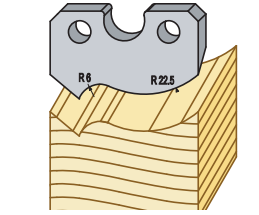

■ 94256HSS

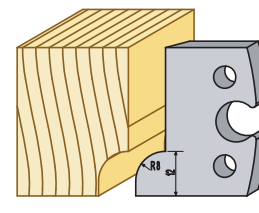

■ 94257HSS

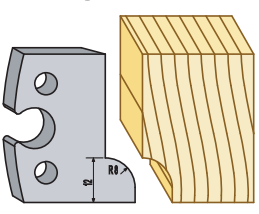

■ 94258HSS

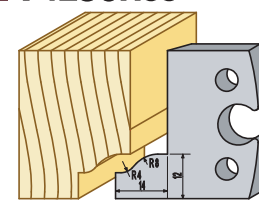

■ 94259HSS

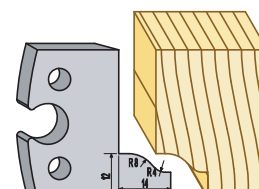

■ 94260HSS

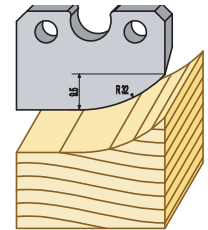

■ 94261HSS

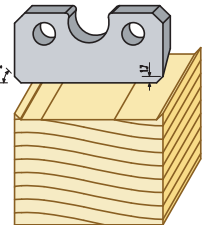

■ 94262HSS

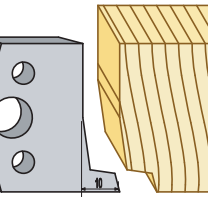

■ 94263HSS

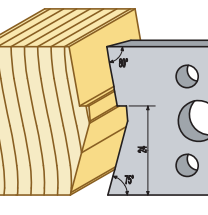

■ 94264HSS

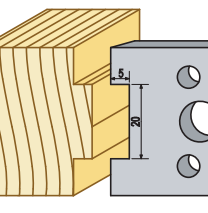

■ 94265HSS

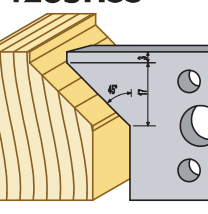

■ 94266HSS

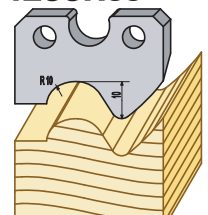

■ 94267HSS

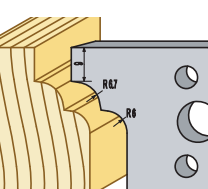

■ 94268HSS

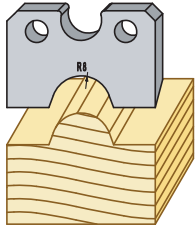

■ 94269HSS

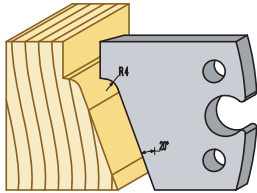

■ 94270HSS

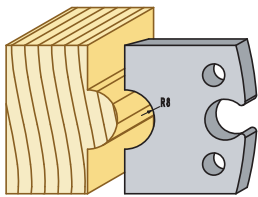

■ 94271HSS

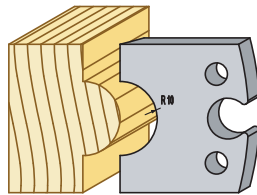

■ 94272HSS

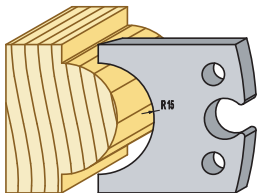

■ 94273HSS

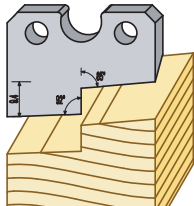

■ 94274HSS

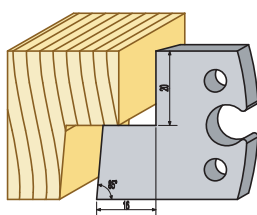

■ 94275HSS

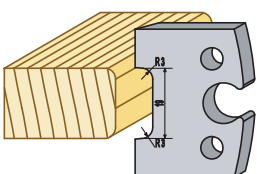

■ 94276HSS

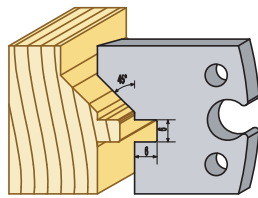

■ 94277HSS

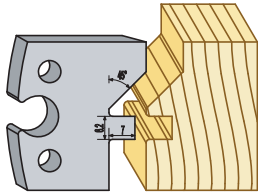

■ 94278HSS

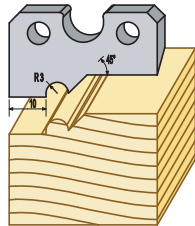

■ 94279HSS

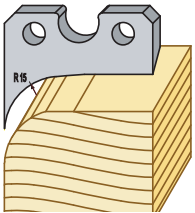

■ 94280HSS

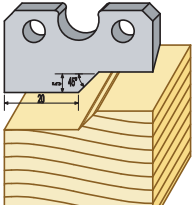

■ 94281HSS

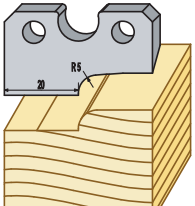

■ 94282HSS

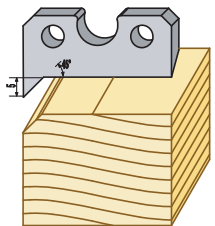

■ 94283HSS

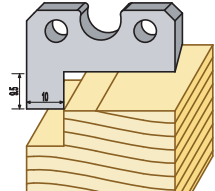

■ 94284HSS

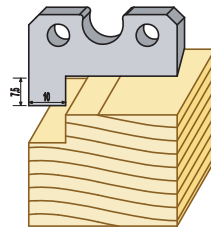

■ 94285HSS

Endast Solohyveln

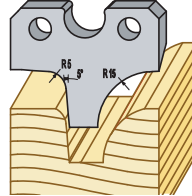

■ 94286HSS

Endast Solohyveln

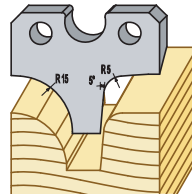

■ 94287HSS

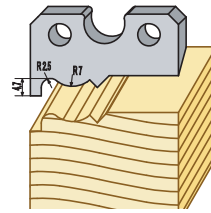

■ 94289HSS

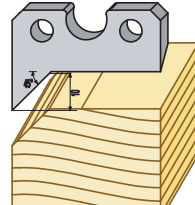

■ 94290HSS

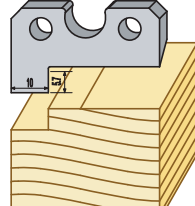

■ 94291HSS

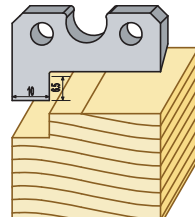

■ 94292HSS

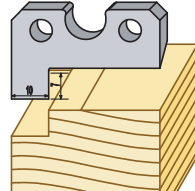

■ 94293HSS

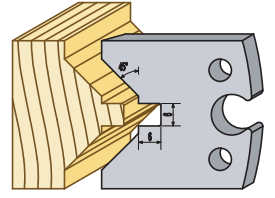

■ 94294HSS

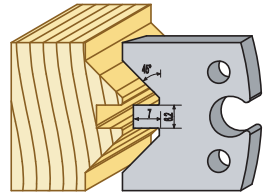

■ 94295HSS

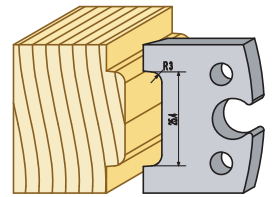

■ 94296HSS

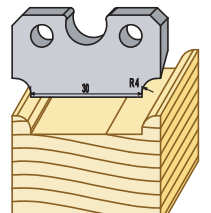

■ 94297HSS

Endast Solohyveln

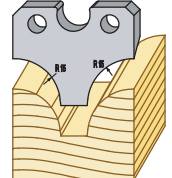

■ 94298HSS

Endast Solohyveln

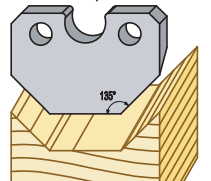

■ 94299HSS

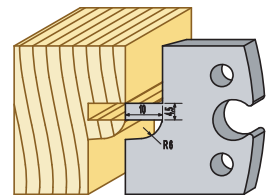

■ 94300HSS

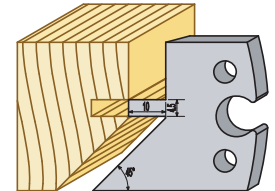

■ 94301HSS

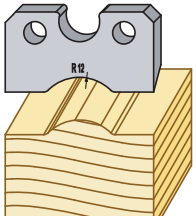

■ 94302HSS

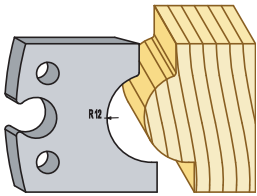

■ 94303HSS

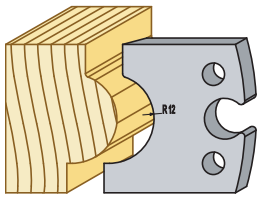

■ 94304HSS

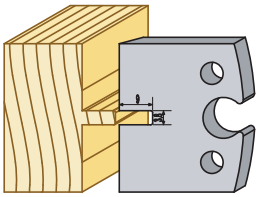

■ 94305HSS

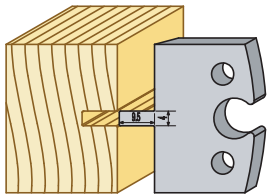

■ 94306HSS

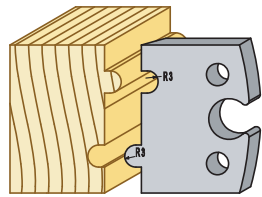

■ 94308HSS

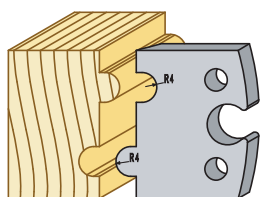

■ 94310HSS

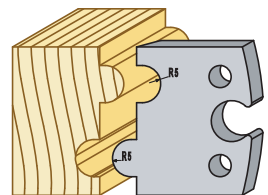

■ 94312HSS

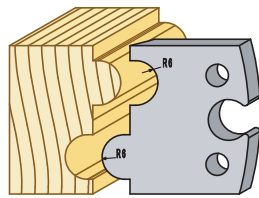

■ 94314HSS

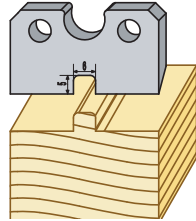

■ 94315HSS

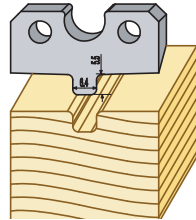

■ 94316HSS

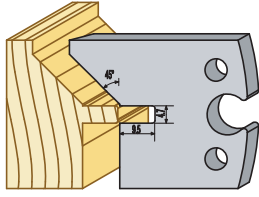

■ 94317HSS

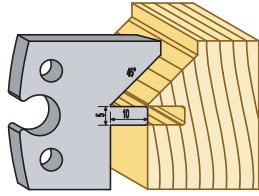

■ 94318HSS

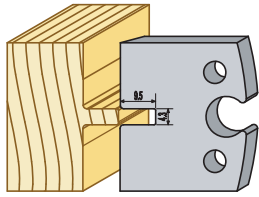

■ 94320HSS

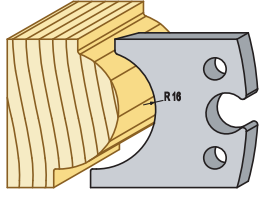

■ 94321HSS

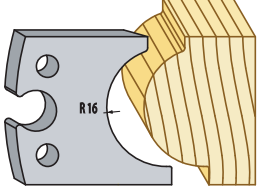

■ 94322HSS

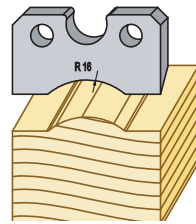

■ 94323HSS

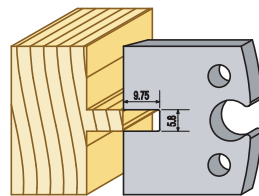

■ 94324HSS

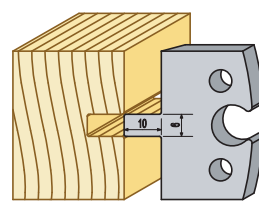

■ 94325HSS

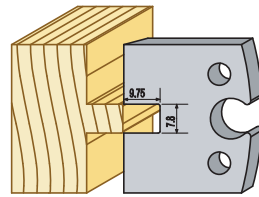

■ 94326HSS

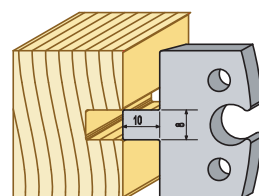

■ 94327HSS

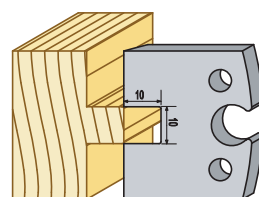

■ 94328HSS

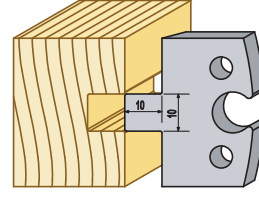

■ 94329HSS

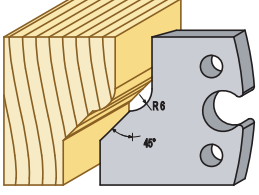

■ 94331HSS

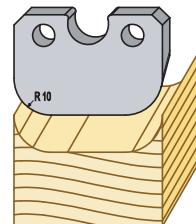

■ 94332HSS

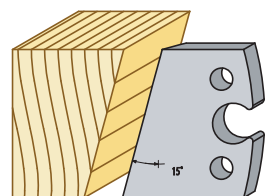

■ 94333HSS

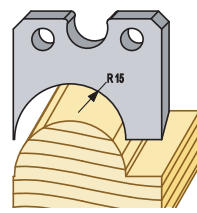

■ 94334HSS

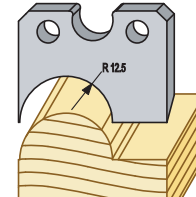

■ 94335HSS

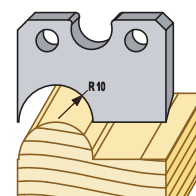

■ 94336HSS

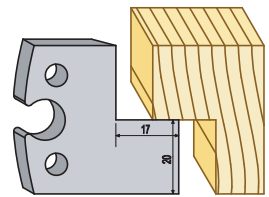

■ 94337HSS

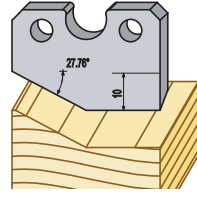

■ 94338HSS

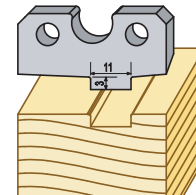

■ 94339HSS

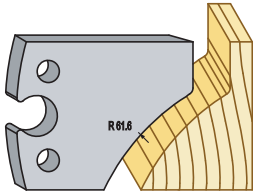

■ 94349HSS

Framtagen för Solohyveln

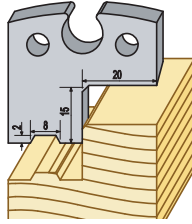

■ 94357HSS

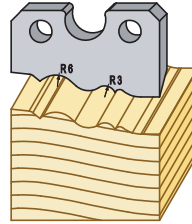

■ 94365HSS

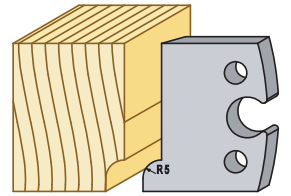

■ 94340HSS

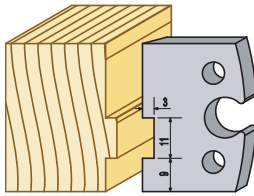

■ 94350HSS

Framtagen för Solohyveln

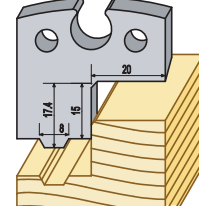

■ 94358HSS

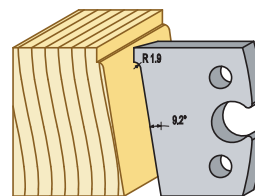

■ 94366HSS

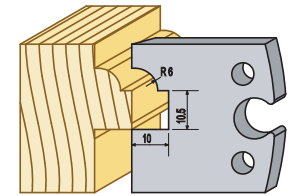

■ 94341HSS

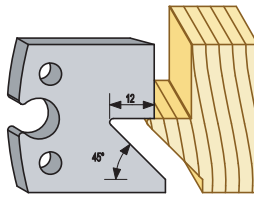

■ 94351HSS

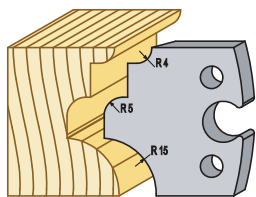

■ 94359HSS

Profildjup 5 mm

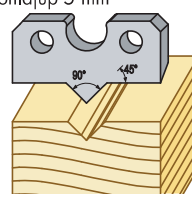

■ 94367HSS

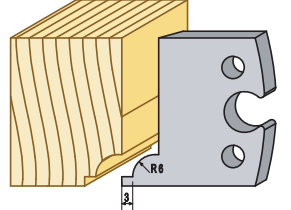

■ 94342HSS

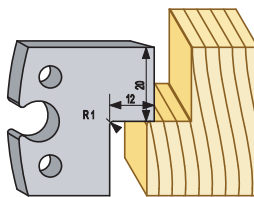

■ 94352HSS

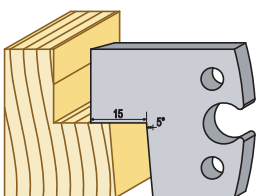

■ 94360HSS

Profildjup 10 mm

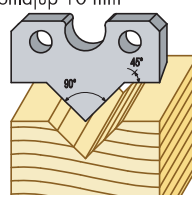

■ 94368HSS

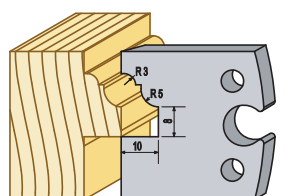

■ 94343HSS

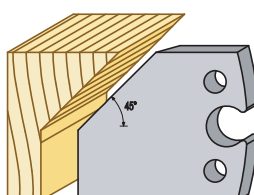

■ 94353HSS

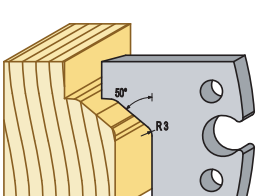

■ 94361HSS

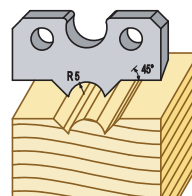

■ 94369HSS

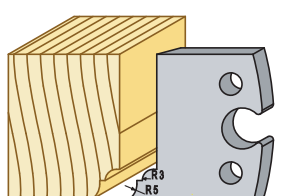

■ 94345HSS

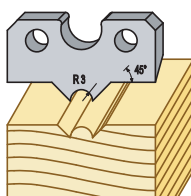

■ 94354HSS

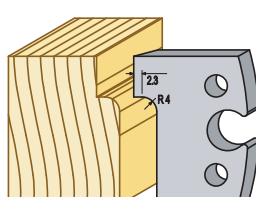

■ 94362HSS

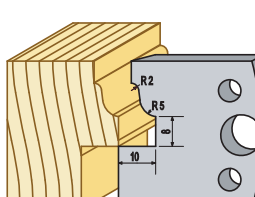

■ 94370HSS

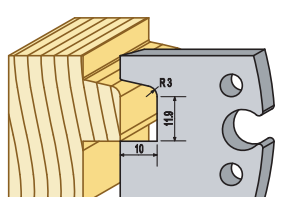

■ 94347HSS

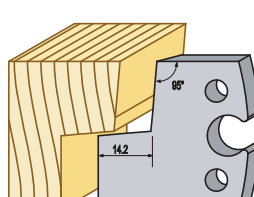

■ 94355HSS

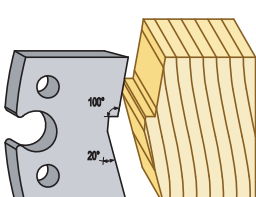

■ 94363HSS

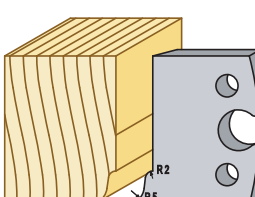

■ 94371HSS

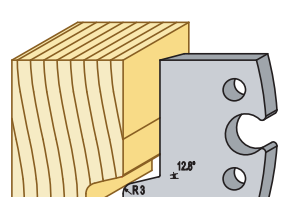

■ 94348HSS

Framtagen för Solohyveln

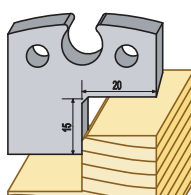

■ 94356HSS

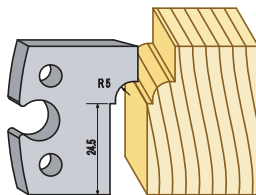

■ 94364HSS

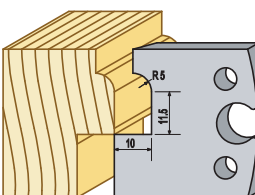

■ 94372HSS

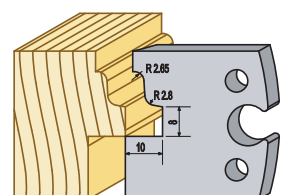

■ 94373HSS

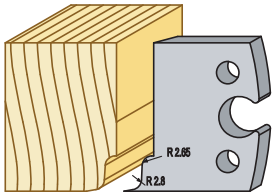

■ 94374HSS

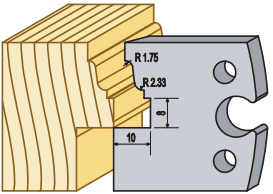

■ 94375HSS

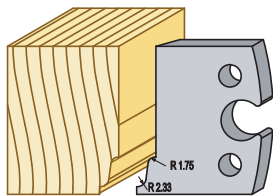

■ 94376HSS

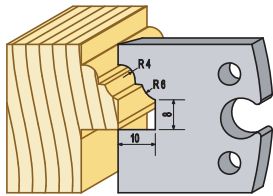

■ 94377HSS

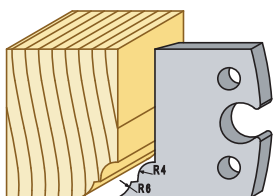

■ 94378HSS

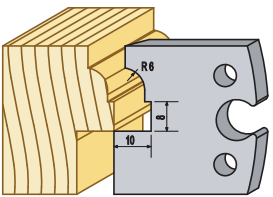

■ 94379HSS

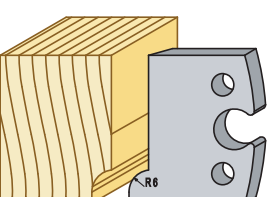

■ 94380HSS

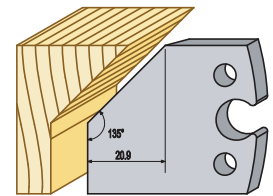

■ 94381HSS

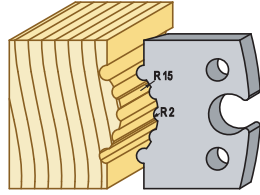

■ 94382HSS

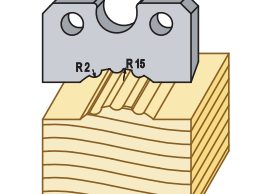

■ 94383HSS

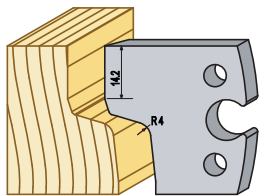

50 mm

■ 9500-20HSS

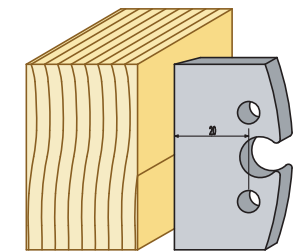

Finns även i 9500-16, 9500-24, 9500-32

■ 95001HSS

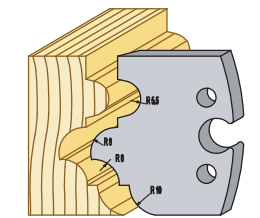

■ 95002HSS

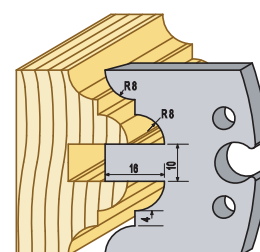

■ 95003HSS

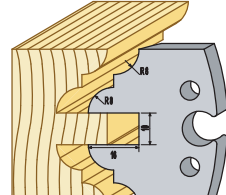

■ 95004HSS

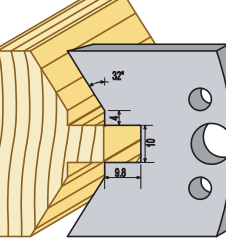

■ 95005HSS

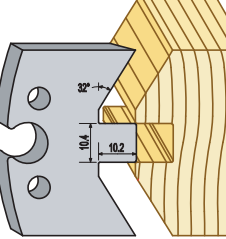

■ 95006HSS

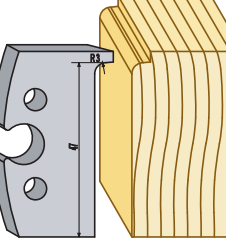

■ 95007HSS

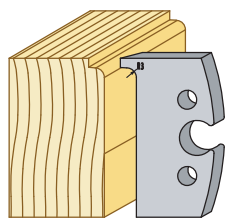

■ 95008HSS

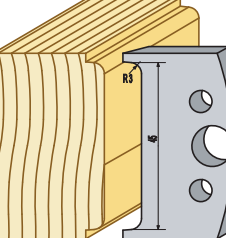

■ 95009HSS

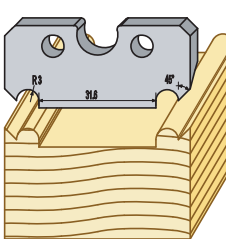

■ 95010HSS

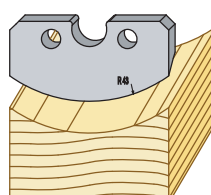

■ 95011HSS

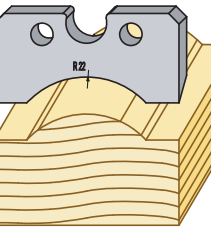

■ 95012HSS

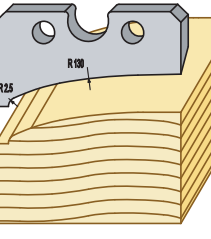

■ 95013HSS

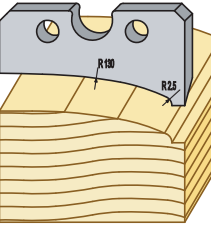

■ 95014HSS

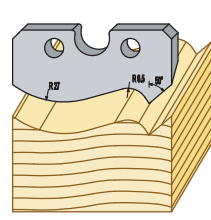

■ 95015HSS

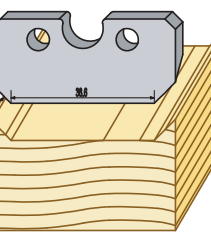

■ 95016HSS

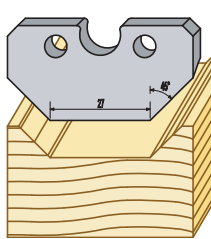

■ 95017HSS

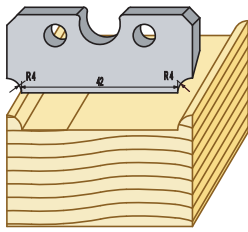

■ 95018HSS

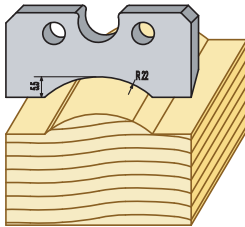

■ 95019HSS

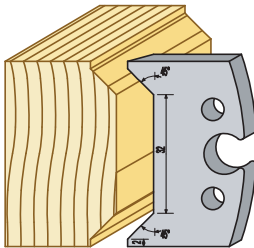

■ 95020HSS

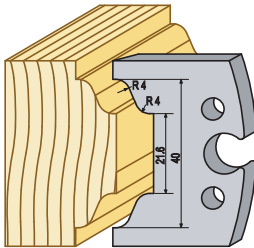

■ 95021HSS

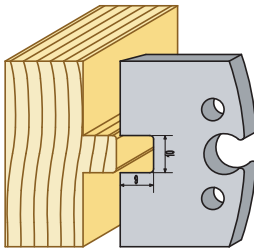

■ 95022HSS

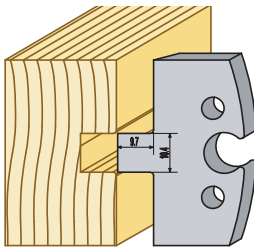

■ 95023HSS

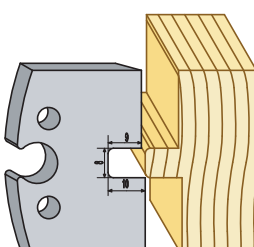

■ 95024HSS

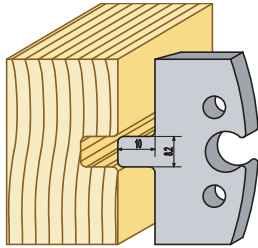

■ 95025HSS

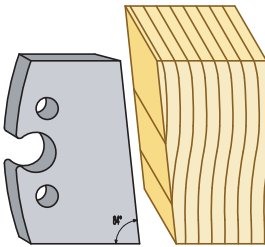

■ 95026HSS

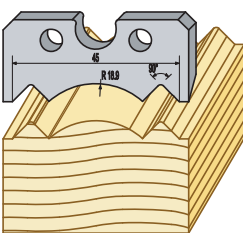

■ 95027HSS

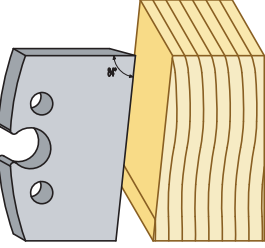

■ 95028HSS

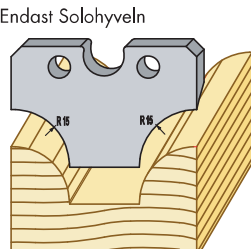

■ 95029HSS

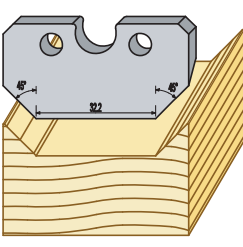

■ 95030HSS

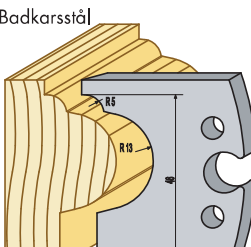

■ 95031HSS

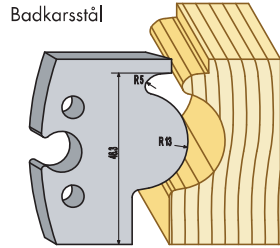

■ 95032HSS

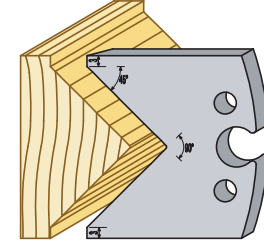

■ 95033HSS

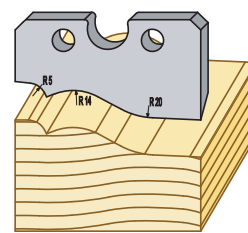

■ 95034HSS

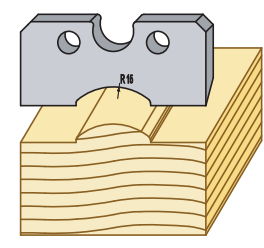

■ 95035HSS

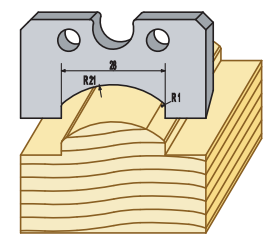

■ 95036HSS

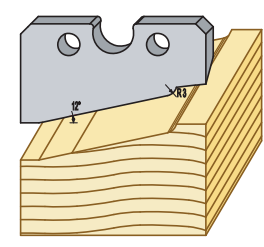

■ 95038HSS

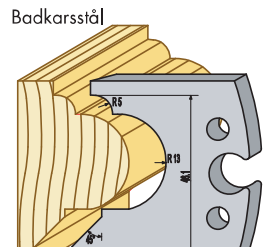

■ 95039HSS

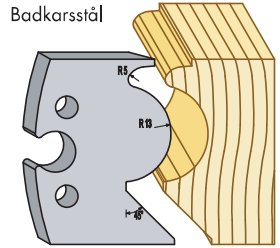

■ 95040HSS

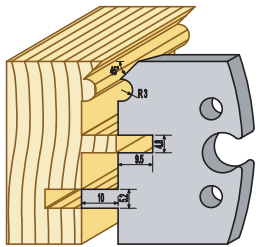

■ 95041HSS

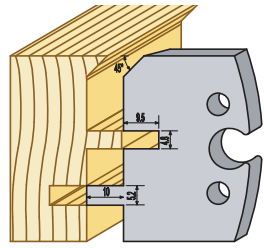

■ 95042HSS

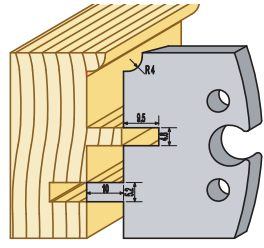

■ 95043HSS

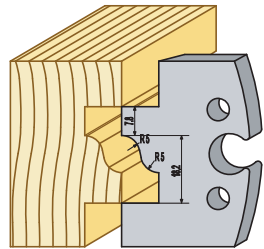

■ 95044HSS

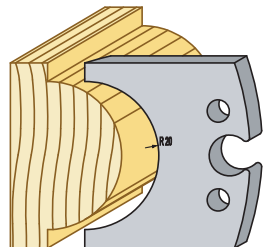

■ 95045HSS

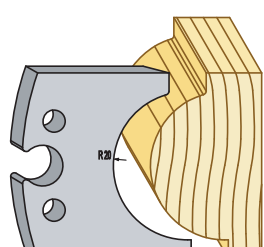

■ 95046HSS

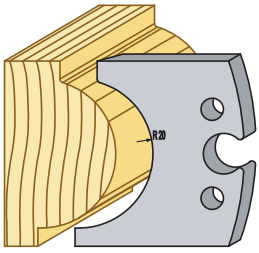

■ 95047HSS

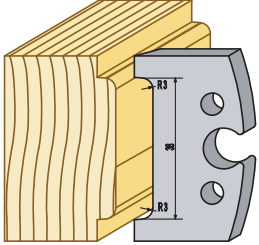

■ 95048HSS

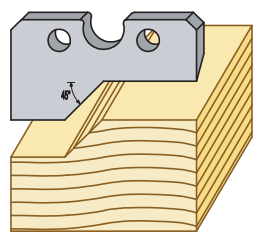

■ 95049HSS

Badkarsstål

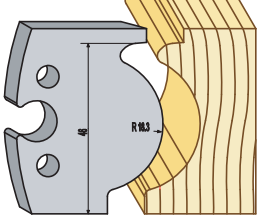

■ 95050HSS

Badkarsstål

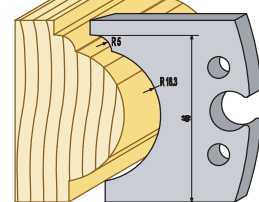

■ 95051HSS

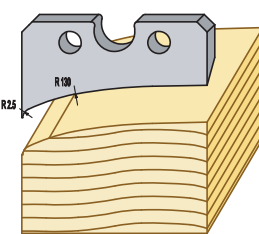

■ 95052HSS

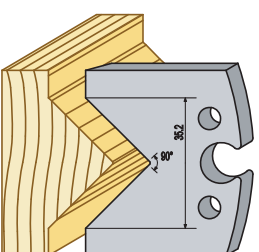

■ 95053HSS

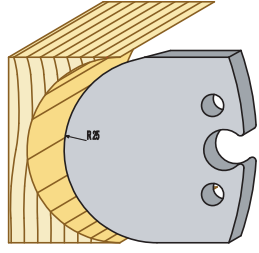

■ 95054HSS

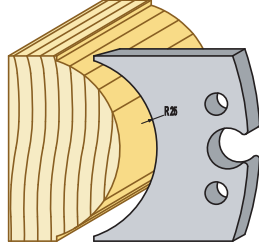

■ 95055HSS

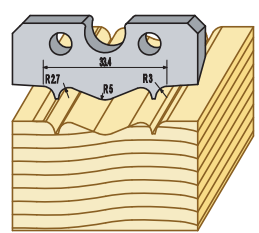

■ 95056HSS

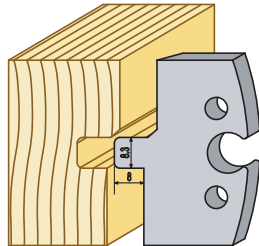

■ 95057HSS

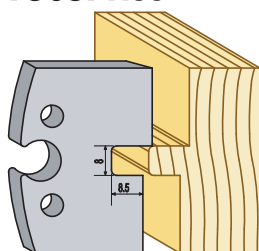

■ 95058HSS

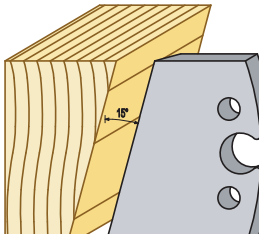

■ 95059HSS

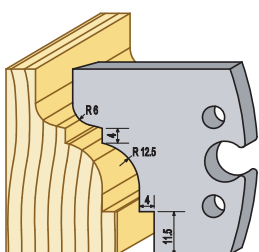

■ 95060HSS

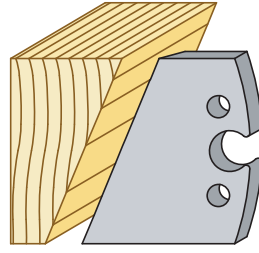

■ 95061HSS

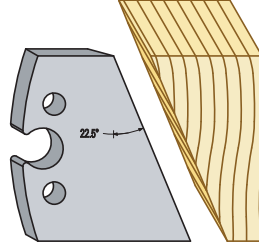

■ 95062HSS

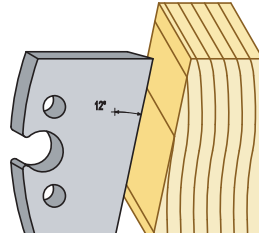

■ 95063HSS

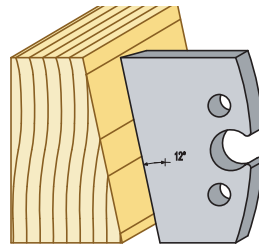

■ 95064HSS

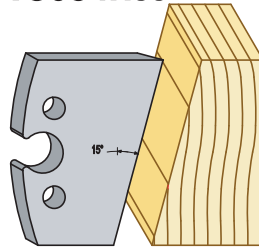

■ 95065HSS

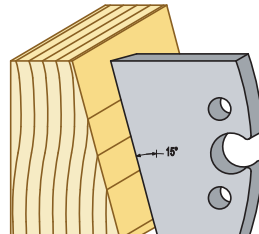

■ 95066HSS

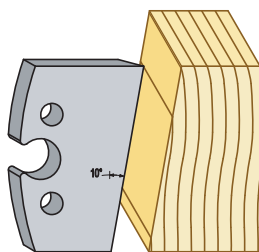

■ 95067HSS

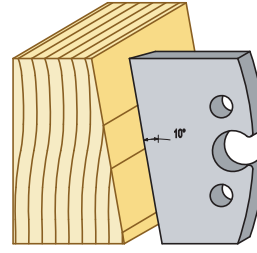

■ 95069HSS

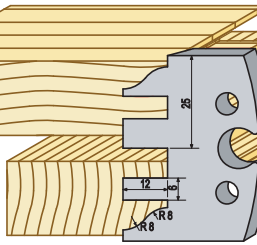

■ 95070HSS

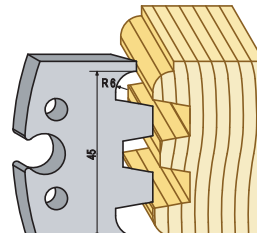

■ 95071HSS

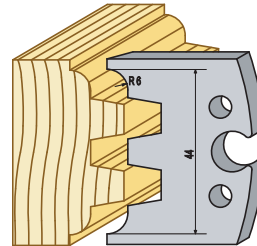

■ 95072HSS

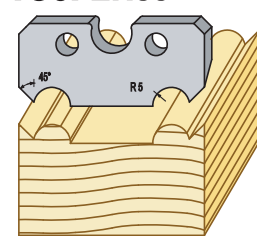

■ 95073HSS

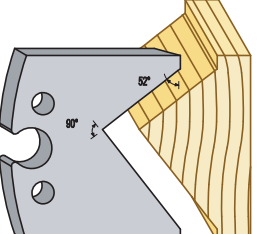

■ 95074HSS

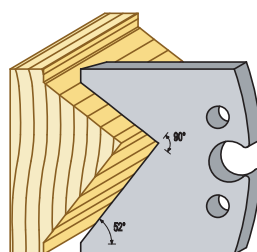

■ 95075HSS

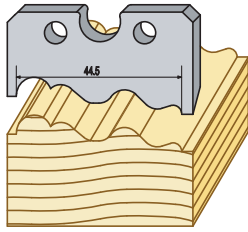

■ 95076HSS

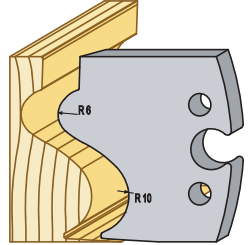

■ 95077HSS

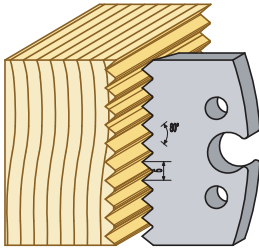

■ 95078HSS

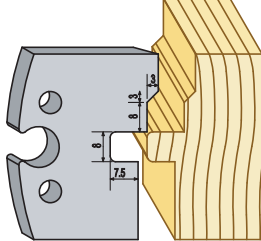

■ 95079HSS

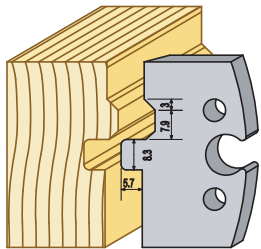

■ 95080HSS

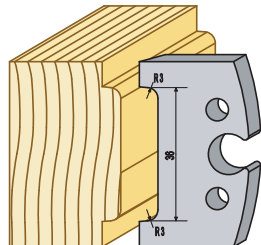

■ 95082HSS

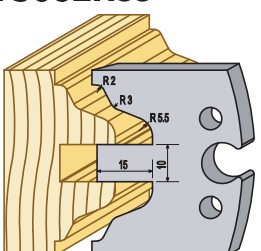

■ 95083HSS

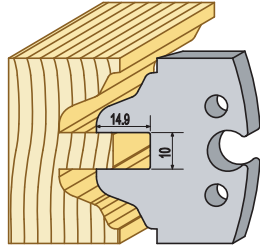

60 mm

■ 9600-20HSS

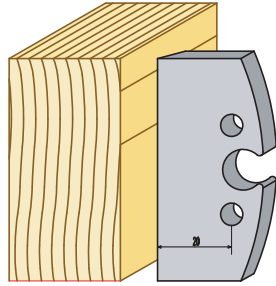

Finns även i 9600-16, 9600-24, 9600-32

■ 96001HSS

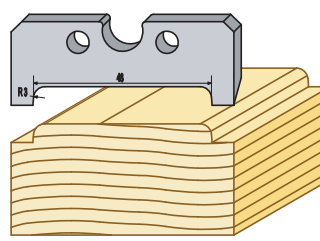

■ 96002HSS

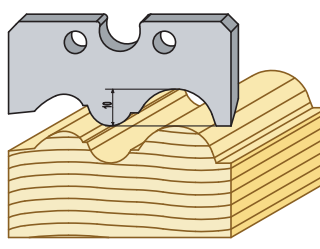

■ 96003HSS

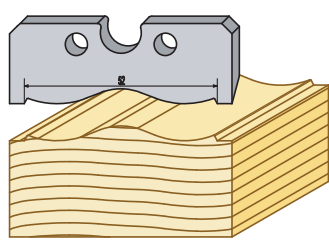

■ 96004HSS

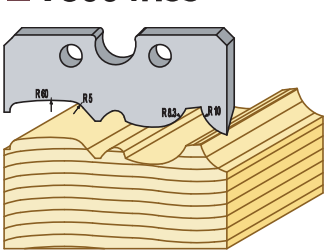

■ 96005HSS

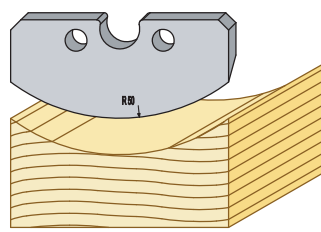

■ 96006HSS

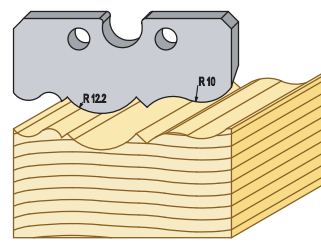

■ 96007HSS

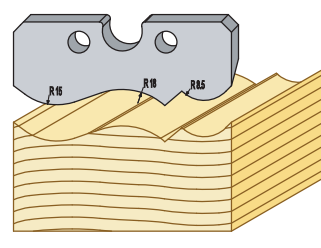

■ 96008HSS

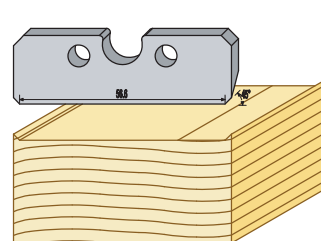

■ 96009HSS

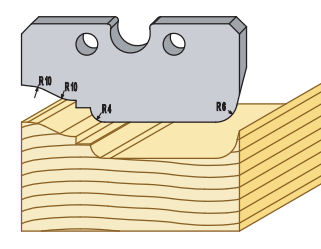

■ 96010HSS

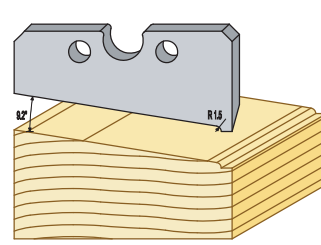

■ 96011HSS

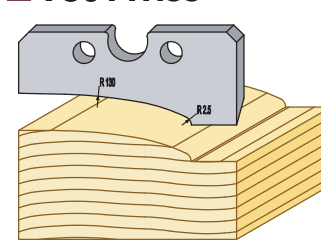

■ 96014HSS

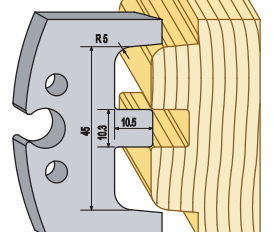

■ 96015HSS

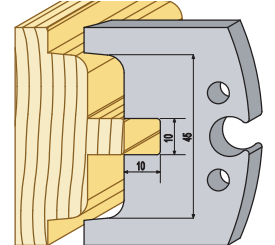

■ 96017HSS

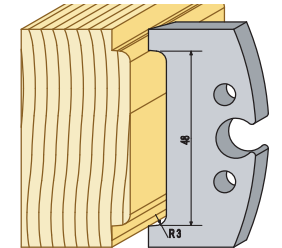

■ 96018HSS

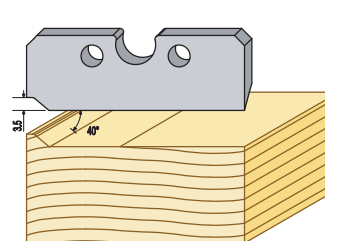

■ 96019HSS

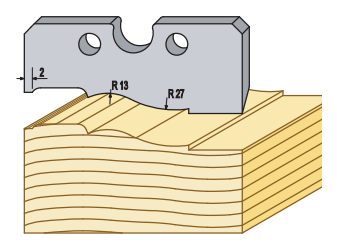

■ 96020HSS

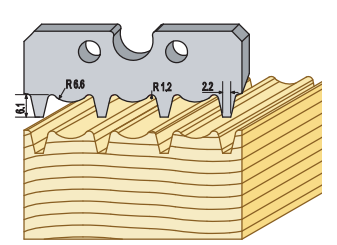

■ 96021HSS

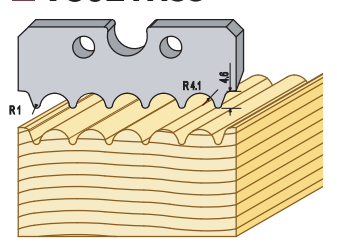

■ 96022HSS

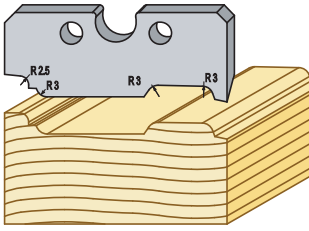

■ 98005HSS

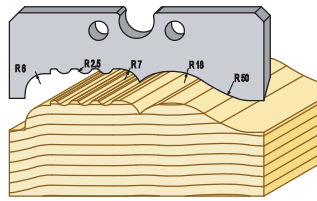

■ 91004HSS

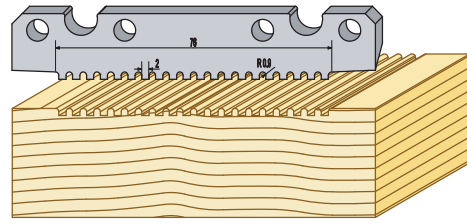

80 mm

■ 98002HSS

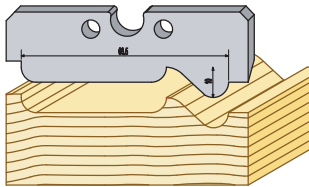

■ 98006HSS

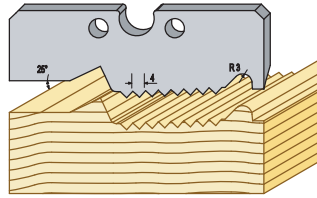

■ 91010HSS Morapanel 95 mm

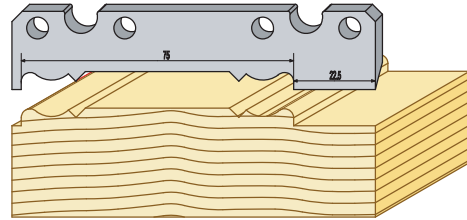

■ 98003HSS

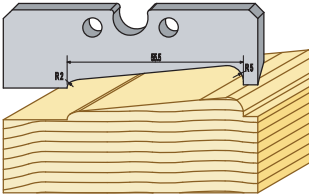

■ 98007HSS

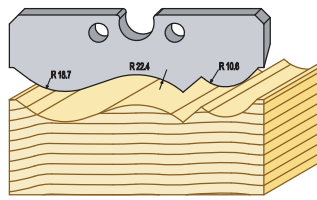

■ 91011HSS Vågig Morapanel 95 mm

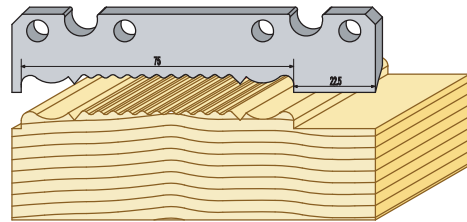

■ 98004HSS

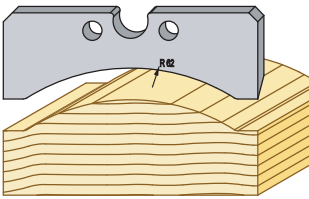

■ 98008HSS

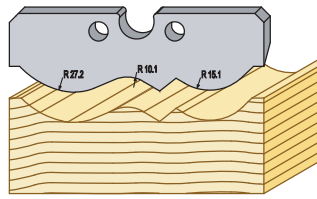

■ 91012HSS Fasadpanel 95 mm

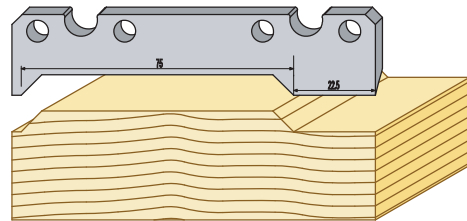

100 mm

■ 91001HSS

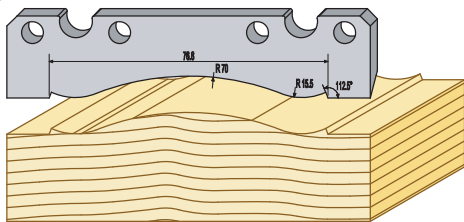

■ 91013HSS Vågig Fasadpanel 95 mm

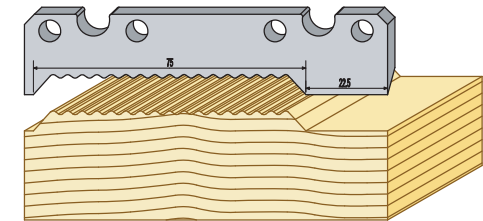

■ 91002HSS

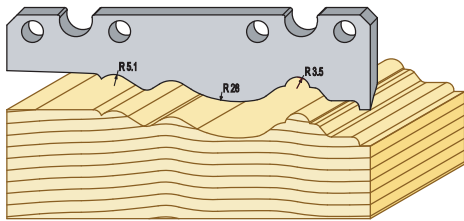

■ 91014HSS Avrundad panel 95 mm

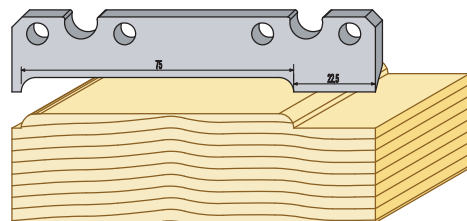

■ 91003HSS

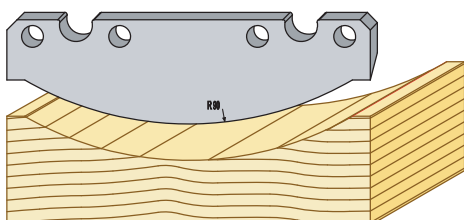

■ 91015HSS Vågig avrundad panel 95 mm

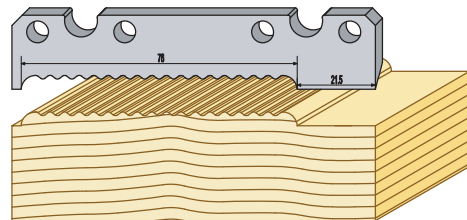

■ **91016HSS** Pärlspont 95 mm

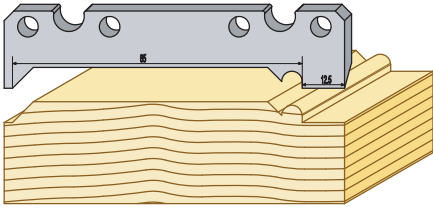

■ **91020HSS**

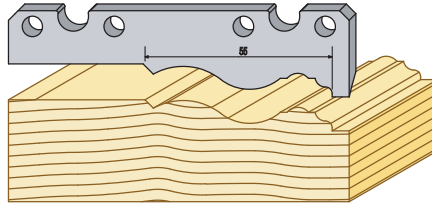

■ **91023HSS**

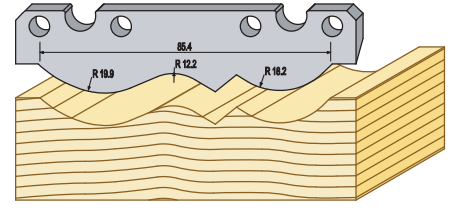

■ **91017HSS** Vågig pärlspont 95 mm

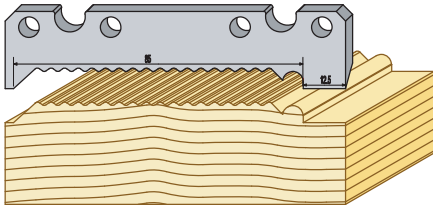

■ **91021HSS**

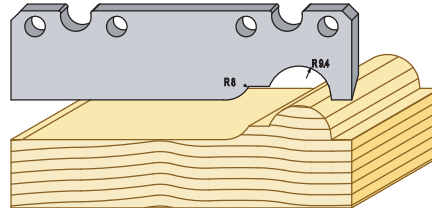

■ **91024HSS**

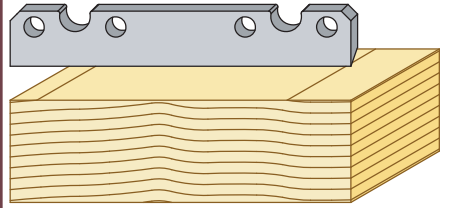

■ **91018HSS** Stockpanel 95 mm

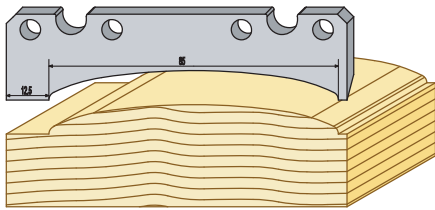

■ **91022HSS**

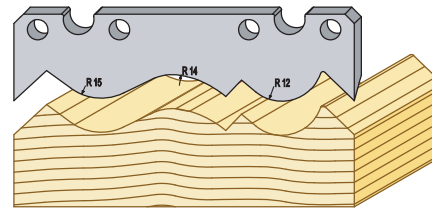

■ **91025HSS**

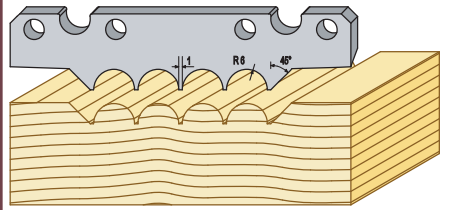

130 mm

■ **91301HSS** Svanhalstaklist

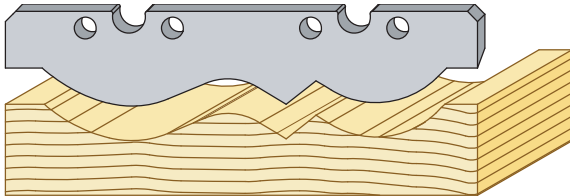

■ **91305HSS**

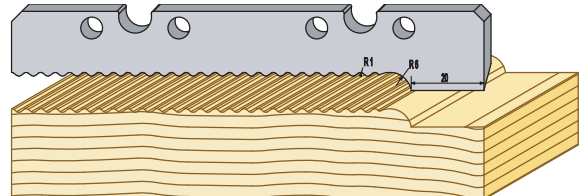

■ **91302HSS**

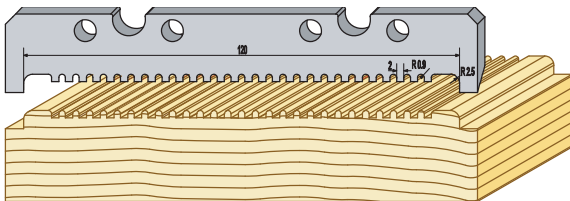

■ **91306HSS**

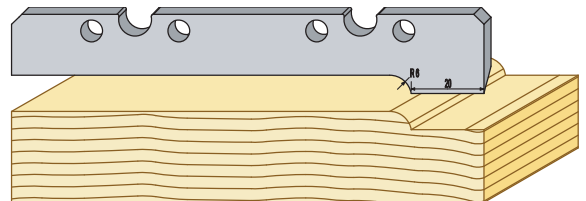

■ **91303HSS**

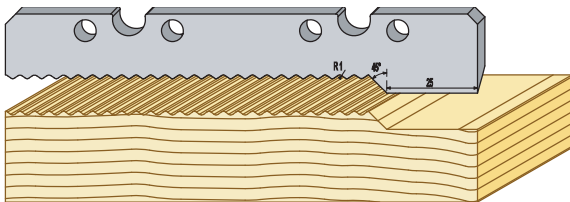

■ **91307HSS**

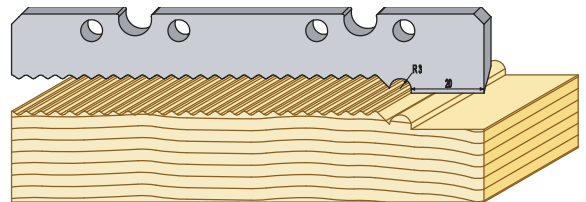

■ **91304HSS**

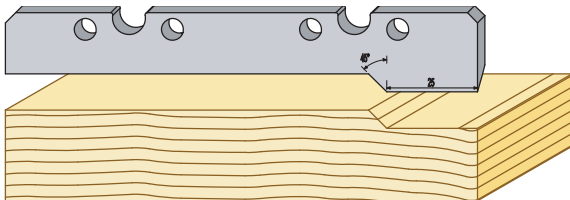

■ **91308HSS**

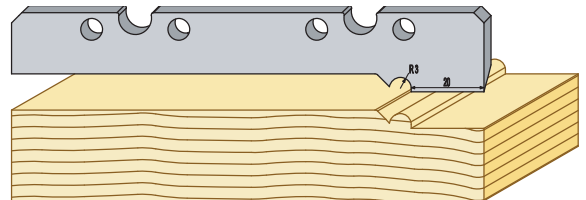

■ **91309HSS**

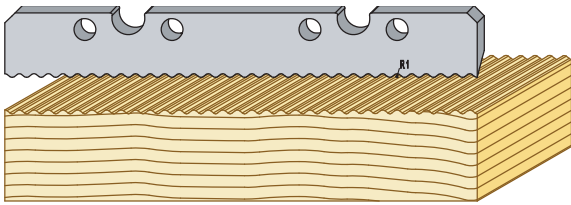

■ **91310HSS** Morapanel 120 mm

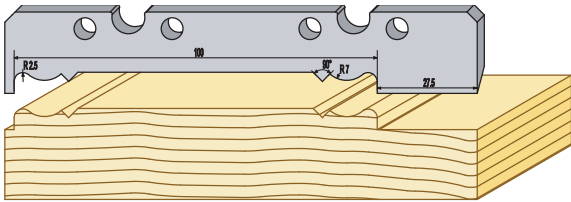

■ **91311HSS** Vågig Morapanel 120 mm

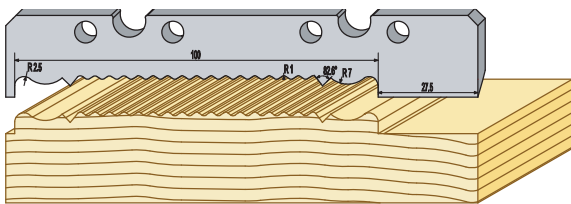

■ **91312HSS** Faspanel 120 mm

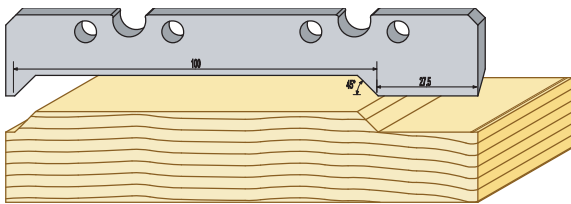

■ **91313HSS** Vågig faspanel 120 mm

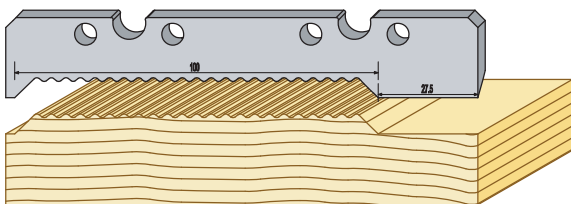

■ **91314HSS** Avrundad panel 120 mm

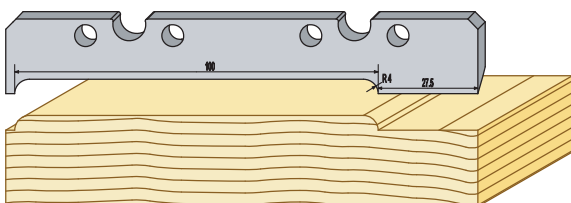

■ **91315HSS** Vågig avrundad panel 120 mm

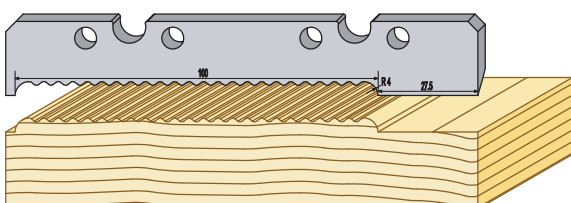

■ **91316HSS** Pärlspont 120 mm

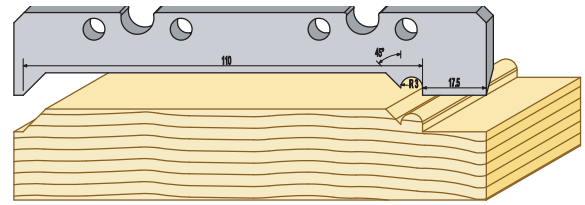

■ **91317HSS** Vågig pärlspont 120 mm

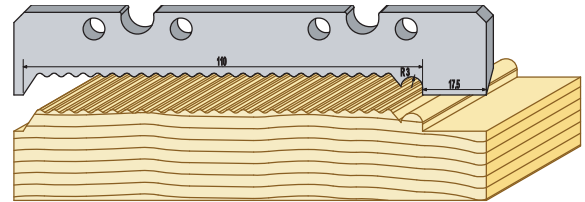

■ **91318HSS** Stockpanel 120mm

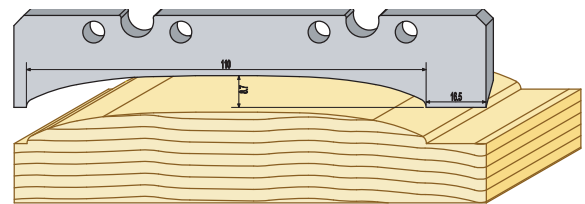

■ **91319HSS** "Sågad" yta

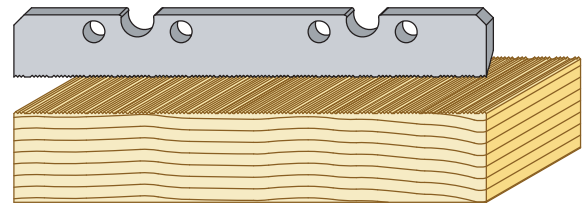

■ **91320HSS**

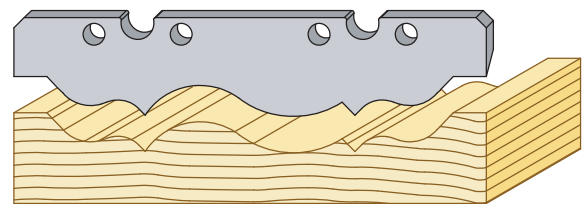

■ **91321HSS**

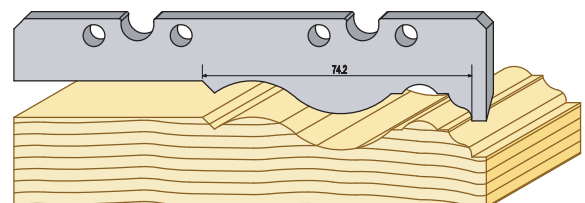

■ **91323HSS**

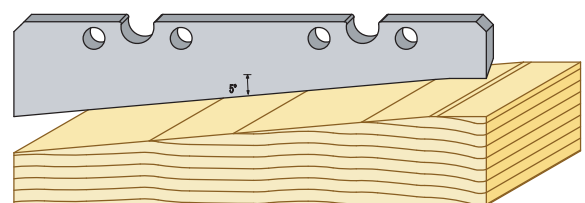

Planstål, 510 mm	
Överkutter MP360, MP365	
1 par	HSS-510

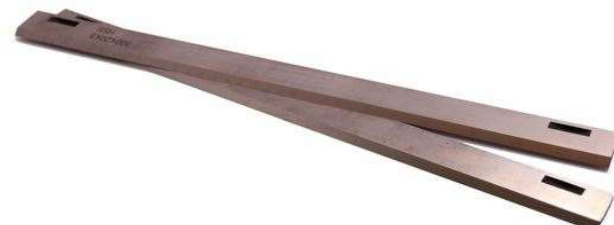

Planstål, 410 mm	
Överkutter MP260, underkutter MP360, MP365	
1 par	HSS-RPH410



Planstål, 300 mm	
Underkutter MP260	
1 par	HSS-PH300



■ 9500-20HSS

Planstål, 50 mm	
Planstål, Sidokutter	
1 par	9500-20HSS

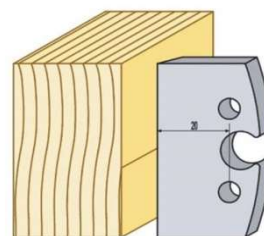

Kutterkil KIL-038	
Kutterkil, Över, underkutter MP260, Underkutter MP280, MP360	
1 par	KIL-038

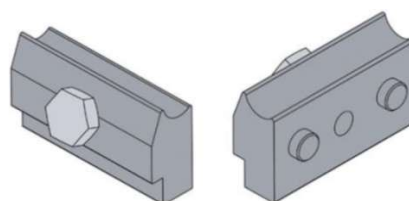

Kutterkil KIL360-048	
Kutterkil, Överkutter MP280, MP360	
1 par	KIL360-048



Kutterkil STÄLLKIL-038	
Kutterkil, Över, underkutter MP260, Underkutter MP280, MP360	
1 par	STÄLLKIL-038



Kutterkil STÄLLKIL360-048	
Kutterkil, Överkutter MP280, MP360	
1 par	STÄLLKIL360-048



Kutter	TB90-92 STÅL Z2		
Kutter	Sidokutter, D88 b40 d30 Z2	2 stål	
1 st	TB90-92 Z2 Stål		



Kutter	TB90-92 STÅL Z4		
Kutter	Sidokutter, D88 b40 d30 Z4	4 stål	
1 st	TB90-92 Z4 Stål		

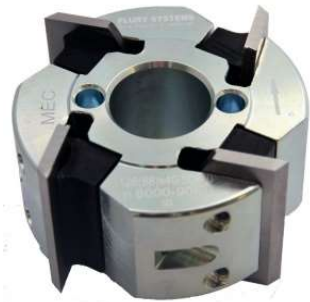

Priser på hyvelstål

HSS-510	800:-
HSS-RPH410	983:-
HSS-PH300	895:-
9500-20HSS	787:-
KIL-038	458:-
STÄLLKIL-038	516:-
TIMKIL-038	492:-
KIL360-048	988:-
STÄLLKIL360-048	1633:-
94000HSS	610:-
95000HSS	787:-
96000HSS	959:-
98000HSS	1392:-
91000HSS	1392:-
91300HSS	1773:-
TB90-92 Z2 Stål Kutter	1524:-
TB90-92 Z4 Stål Kutter	2305:-

2023-07-15

Moms tillkommer på alla priser.



Wood-Mizer
from forest to final form

MEKWOOD AB

Magasinsgatan 29, 812 31 Storvik - 0290-515 65, 070-679 79 65

info@mekwood.se - www.mekwood.se - www.woodmizer.se